

SecurView® RT Workstation DICOM Conformance Statement

Software Version 9.0

MAN-05203 Revision 001

SecurView®
Breast Imaging Workstation



HOLOGIC®



SecurView[®] RT 9.0 Workstation

DICOM Conformance Statement

MAN-05203 Rev 001

HOLOGIC[®]

Technical Support
In the USA: +1.877.371.4372
In Europe: +32.2.711.4690
Asia: +852 37.48.77.00
All other: +1.781.999.7750
Email: mammosupport@hologic.com

© 2017, Hologic, Inc. Printed in the USA. This manual was originally written in English.

Hologic, Cenova, Dimensions, Lorad, R2 Technology, SecurView, Selenia and associated logos are trademarks and/or registered trademarks of Hologic, Inc., and/or its subsidiaries in the United States and/or other countries. All other trademarks, registered trademarks, and product names are the property of their respective owners.

This product may be protected by one or more U.S. or foreign patents as identified at www.Hologic.com/patents.

 **Hologic, Inc.**
36 Apple Ridge Road
Danbury, CT, 06810 USA
Tel: +1.781.999.7300

 **Hologic Ltd.**
(EU Representative)
Heron House Oaks Business
Park
Crewe Road, Wythenshawe
Manchester M23 9HZ, UK
Tel: +44.0.161.946.2206

For more information about
Hologic products and services,
visit www.Hologic.com.

CE 0044

1. Overview

The Hologic SecurView RT workstation is used primarily by radiologic technologists to view digital mammography images. The SecurView RT workstation implements the necessary DICOM services to receive images and related information from networked devices, query for images and related information from a networked storage device, retrieve images and related information from a networked storage device, send and receive Notices with SecurView DX workstations, and print to a networked hardcopy device.

Table 1-1 provides an overview of the network services supported by the SecurView RT workstation.

Table 1-1 – Network Services

SOP Classes	User of Service (SCU)	Provider of Service (SCP)
Transfer		
Computed Radiography Image Storage	No	Yes
Digital X-Ray Image Storage – For Presentation	No	Yes
Digital Mammography X-Ray Image Storage – For Presentation	No	Yes
Digital Mammography X-Ray Image Storage – For Processing	No	Yes
Breast Tomosynthesis Image Storage	No	Option
Secondary Capture Image Storage	No	Yes
Multi-frame Grayscale Byte Secondary Capture Image Storage	No	Yes
Multi-frame Grayscale Word Secondary Capture Image Storage	No	Yes
Multi-frame True Color Secondary Capture Image Storage	No	Yes
Ultrasound Image Storage	No	Yes
Ultrasound Multi-frame Image Storage	No	Yes
Ultrasound Image Storage (Retired)	No	Yes
Ultrasound Multi-frame Image Storage (Retired)	No	Yes
CT Image Storage	No	Option
Mammography CAD SR	No	Yes
Grayscale Softcopy Presentation State Storage	Yes	Yes
Print Management		
Basic Grayscale Print Management Meta SOP Class: <i>includes Basic Film Session, Basic Film Box, Basic Grayscale Image Box, Printer</i>	Yes	No
Presentation LUT	Option	No
Query/Retrieve		
Study Root Query/Retrieve Information Model – FIND	Yes	No
Study Root Query/Retrieve Information Model – MOVE	Yes	No

1. Overview

Table 1-2 provides an overview of the Media Storage Application Profiles supported by the SecurView RT workstation.

Table 1-2 – Media Services

Media Storage Application Profile	Write Files (FSC or FSU)	Read Files (FSR)
Compact Disk - Recordable		
General Purpose CD-R	Yes	Yes
DVD		
General Purpose DVD-RAM	Yes	Yes
USB		
General Purpose USB	Yes	Yes

2. Table of Contents

1. Overview	1
2. Table of Contents	3
3. Introduction	5
3.1. Audience	5
3.2. Remarks	5
3.3. Definitions, Terms and Abbreviations	6
3.4. References	6
4. Networking	7
4.1. Implementation Model	7
4.1.1. Application Data Flow	7
4.1.2. Functional Definition of AEs	8
4.1.3. Sequencing of Real-World Activities	9
4.2. AE Specifications	11
4.2.1. SCU AE	11
4.2.2. SCP AE	22
4.3. Network Interfaces	26
4.3.1. Physical Network Interface	26
4.3.2. Additional Protocols	26
4.4. Configuration	26
4.4.1. AE Title/Presentation Address Mapping	26
4.4.2. Configuration Parameters	27
5. Media Interchange	29
5.1. Implementation Model	29
5.1.1. Application Data Flow Diagram	29
5.1.2. Functional Definition of AEs	29
5.1.3. Sequencing of Real-world Activities	29
5.1.4. File Meta Information for Implementation Class Version	29
5.2. AE Specifications	30
5.2.1. Media Server AE Specification	30
5.3. Augmented and Private Application Profiles	31
5.4. Media Configuration	32
6. Support of Character Sets	32
7. Security	32

8. Annexes	33
8.1. IOD Contents	33
8.1.1. Created SOP Instance(s)	33
8.1.2. Usage of Attributes from Received IODs	38
8.1.3. Attribute Mapping	41
8.1.4. Coerced/Modified Attributes	41
8.2. Data Dictionary of Private Attributes	41
8.3. Coded Terminology and Templates	41
8.4. Grayscale Image Consistency	41
8.5. Standard Extended/Specialized/Private SOP Classes	41
8.6. Private Transfer Syntaxes	41

3. Introduction

Hologic, Inc. develops and markets a full line of mammography products including the SecurView RT workstation, for use by radiologic technologists to facilitate easier image workflow with the SecurView DX diagnostic review workstation and the Selenia® and Selenia Dimensions® full-field digital mammography systems.

The SecurView RT workstation provides a user interface for viewing digital mammography and other breast imaging procedures, and for exchanging Notices with SecurView DX workstations. The SecurView RT workstation includes a graphical user interface (GUI) with a pointing device, keyboard, and one display.

3.1. Audience

This document contains the DICOM conformance claim for the SecurView RT workstation. This document is intended to aid in connecting the SecurView RT workstation to other components that make use of the DICOM standard for interconnecting networked diagnostic review workstation devices.

The information within this document applies to SecurView RT software version 9.x. The reader of this document should be familiar with the DICOM standard and PACS components that utilize the standard.

3.2. Remarks

A DICOM conformance statement – the structure and content of which are stipulated by the DICOM standard – is intended to aid in determining the suitability of interconnecting digital imaging devices. References to specific functionality in a conformance statement are not sufficient to guarantee interoperability between components. The following should be considered when evaluating interoperability:

- The SecurView RT workstation conformance statement provides a starting point for ascertaining whether the product can communicate with other systems.
- The only way to know for certain whether the SecurView RT workstation can interoperate with other systems is to perform connectivity testing.
- This document represents a best effort to document the functionality of commercial versions of the SecurView RT workstation and is not a functional specification of any Hologic component or product. Hologic reserves the right to make changes at any time to the functionality of the DICOM components described herein, and is committed to following the evolution of the DICOM standard.

3.3. Definitions, Terms and Abbreviations

AE: Application Entity

CAD: Computer Aided Detection

CT: Computed Tomography

DICOM: Digital Imaging and Communications in Medicine

DIMSE: DICOM Message Service Element

GSPPS: Grayscale Softcopy Presentation State

IOD: Information Object Definition

JPEG: Joint Photographic Experts Group (data compression techniques)

LUT: Lookup Table

MR: Magnetic Resonance

NEMA: National Electrical Manufacturers Association

NM: Nuclear Medicine

PACS: Picture Archive and Communications System (image management & long-term storage)

PET: Positron Emission Tomography

PDU: Protocol Data Unit

Q/R: Query/Retrieve

RLE: Run Length Encoding (data compression technique)

SC: Secondary Capture

SCP: Service Class Provider

SCU: Service Class User

SOP: Service Object Pair

SR: Structured Report

TCP/IP: Transmission Control Protocol/Internet Protocol

UID: Unique Identifier

VOI: Value of Interest

3.4. References

NEMA PS3 / ISO 12052, *Digital Imaging and Communications in Medicine (DICOM) Standard*, National Electrical Manufacturers Association, Rosslyn, VA, USA (available free at <http://medical.nema.org/>)

4. Networking

4.1. Implementation Model

4.1.1. Application Data Flow

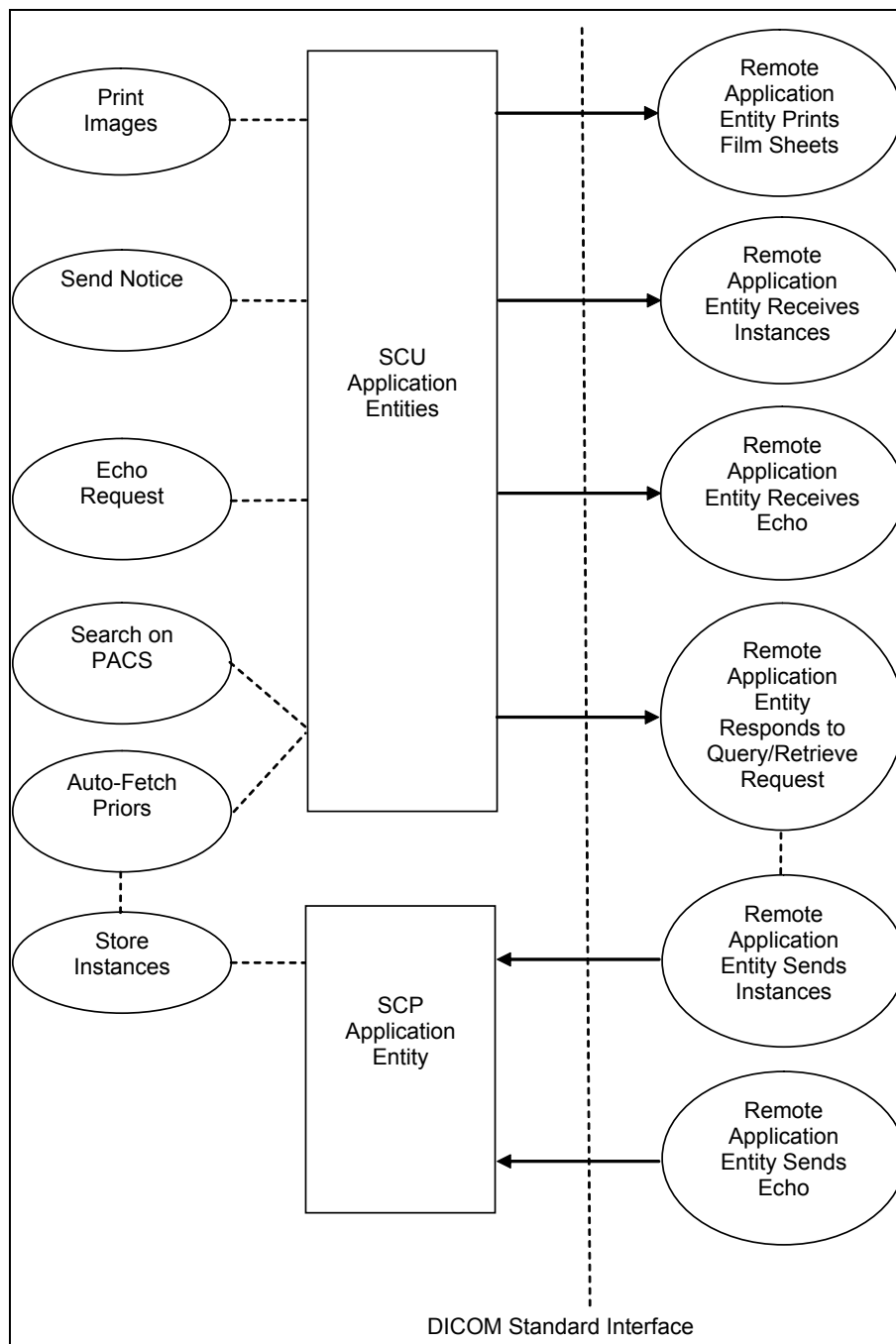

Figure 4.1-1 – Functional Overview

An overview of the real-world activities and AEs is provided below:

- The **Print Images** real-world activity triggers an SCU Application Entity to print selected images to film on a selected remote AE (Printer).
- The **Send Notice** real-world activity triggers an SCU Application Entity to send a Notice (markings, annotations, measurements) created by the radiologic technologist to one or more selected remote AEs, such as SecurView DX workstations.
- The **Echo Request** real-world activity triggers an SCU Application Entity to send an echo request to a selected remote AE.
- The **Search on PACS** real-world activity triggers an SCU Application Entity to query a remote AE for patient studies, series, or instances (based on configured query level) and provides the list of matching responses. The user selects patient studies, series, or instances to be retrieved. The SCU Application Entity issues a retrieve request for each selected study, series, or instance, based on the configured level.
- The SCP Application Entity is always available to receive instances from a remote AE, and triggers the **Store Instances** real-world activity to make them available to the user.
- If configured to do so, the **Store Instances** real-world activity may trigger the **Auto-Fetch Priors** real-world activity. The **Auto-Fetch Priors** real-world activity triggers an SCU Application Entity to query and retrieve studies, series, or instances related to a received instance (e.g. prior images, images related to a Notice). The amount and types of instances to retrieve are configurable.

4.1.2. Functional Definition of AEs

The SCU Application Entities and SCP Application Entity are implemented as separate processes that run in the background. They are started automatically during startup of the SecurView RT workstation.

4.1.2.1. Functional Definition of SCU Application Entities

The SCU Application Entities initiate Print, Store, Echo, and Query/Retrieve requests as needed by the SecurView RT workstation.

4.1.2.2. Functional Definition of SCP Application Entity

The SCP Application Entity is available to accept echo and storage requests whenever the SecurView RT workstation is running. The SCP Application Entity stores received instances locally.

4.1.3. Sequencing of Real-World Activities

For Print Images, a user triggers an SCU AE to perform DICOM print by selecting one or more images, or a portion of the screen from the reviewing display to print to a selected Print Provider.

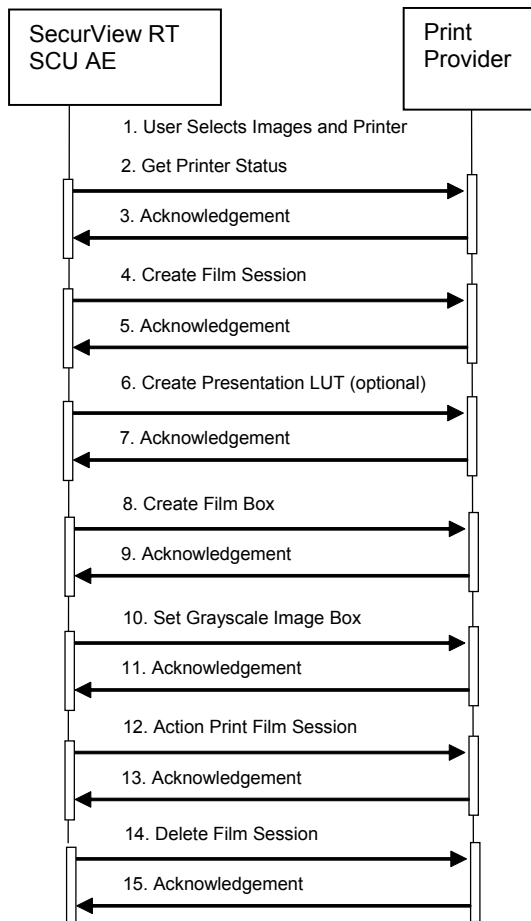

Figure 4.1-2: Print Images Sequence Diagram

For Send Notice, a user triggers an SCU AE to perform DICOM store by creating markings, annotations, and/or measurements on a displayed image and requesting Send Notice to one or more remote AEs.

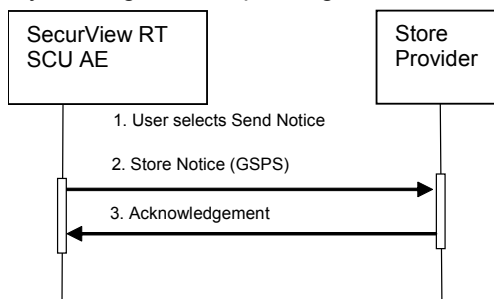

Figure 4.1-3: Send Notice Sequence Diagram

For Search on PACS, a user triggers an SCU AE to perform DICOM query/retrieve by entering search criteria and executing a query. The matching patients' studies, series, or instances are displayed to the user, based on query level configuration. The user selects one or more series to retrieve and executes a retrieve request. The SCP AE receives the instances sent by the Query/Retrieve Provider in response to the retrieve request.

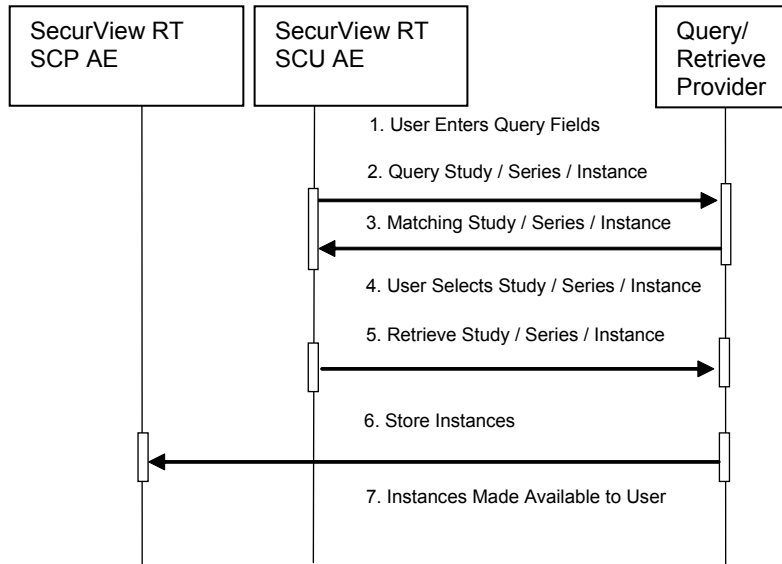

Figure 4.1-4: Search on PACS Sequence Diagram

For Auto-Fetch Priors, receiving an instance such as the first newly captured digital mammography image for a patient triggers an SCU AE to perform DICOM query/retrieve to search for studies matching the patient. Configurable auto-fetch criteria determine types of received instances that trigger auto-fetch, and the (if configured) follow-up series and instance level query content. The SCU AE retrieves the matching studies, series, or instances that meet the auto-fetch criteria. The SCP AE receives the instances sent by the Query/Retrieve Provider.

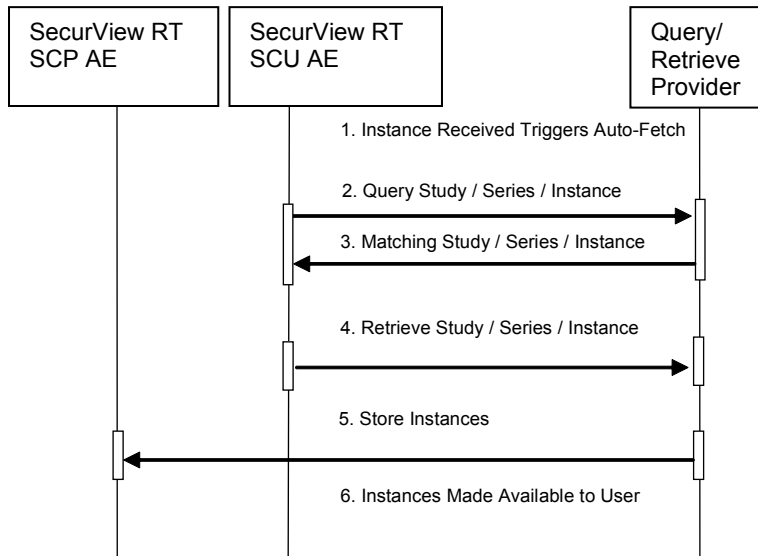

Figure 4.1-5: Auto-Fetch Priors Sequence Diagram

4.2. AE Specifications

4.2.1. SCU AE

4.2.1.1. SOP Classes

The SCU AE provides Standard Conformance to the following SOP Classes:

Table 4.2.1-1 – SOP Classes for SCU AE

SOP Class Name	SOP Class UID	SCU	SCP
Basic Grayscale Print Management Meta	1.2.840.10008.5.1.1.9	Yes	No
Presentation LUT	1.2.840.10008.5.1.1.23	Yes	No
Grayscale Softcopy Presentation State Storage	1.2.840.10008.5.1.4.1.1.11.1	Yes	No
Verification	1.2.840.10008.1.1	Yes	No
Study Root Query/Retrieve Information Model – FIND	1.2.840.10008.5.1.4.1.2.2.1	Yes	No
Study Root Query/Retrieve Information Model – MOVE	1.2.840.10008.5.1.4.1.2.2.2	Yes	No

4.2.1.2. Association Policies

4.2.1.2.1. General

The DICOM standard Application context shall be specified.

Table 4.2.1-2 – DICOM Application Context

Application Context Name	1.2.840.10008.3.1.1.1
--------------------------	-----------------------

4.2.1.2.2. Number of Associations

The SCU AE supports multiple associations. There are no enforced limits for the number of open associations.

4.2.1.2.3. Asynchronous Nature

The SecurView RT workstation does not support asynchronous operations (multiple outstanding transactions over a single Association).

4.2.1.2.4. Implementation Identifying Information

Table 4.2.1-3 – DICOM Implementation Class and Version for SCU AE

Implementation Class UID	1.2.276.0.28.3.0.12.900000
Implementation Version Name	MBC_SCR_0900000

4.2.1.3. Association Initiation Policy

4.2.1.3.1. Print Images

4.2.1.3.1.1. Description and Sequencing of Activities

Print Images is triggered when a user selects to print selected images to a selected remote Print AE either for diagnostic print or screen capture print. The SCU AE attempts to establish an association with a remote Print AE when a request to print one or more images is received. A remote Print AE configuration is predefined for each known printer manufacturer, model, and default film size. Use of the Presentation LUT SOP Class is configurable per printer.

Print requests can be queued, in that a new print request can be initiated before previous print requests are completed. Each print request consists of Printer N-GET, Film Session N-CREATE, Presentation LUT N-CREATE (optional), Film Box N-CREATE, Grayscale Image Box N-SET, Film Session N-ACTION, and Film Session N-DELETE. One association is negotiated per print request. The association is released after the N-DELETE response is received, if not released earlier due to failure.

4.2.1.3.1.2. Proposed Presentation Contexts

The SCU AE attempts to establish associations using the following presentation contexts:

Table 4.2.1-4 – Proposed Presentation Contexts for Print Images

Presentation Context Table					
Abstract Syntax		Transfer Syntax		Role	Extended Negotiation
Name	UID	Name List	UID List		
Basic Grayscale Print Management Meta	1.2.840.10008.5.1.9	Implicit VR, Little Endian	1.2.840.10008.1.2	SCU	None
		Explicit VR, Little Endian	1.2.840.10008.1.2.1	SCU	None
Presentation LUT	1.2.840.10008.5.1.23	Implicit VR, Little Endian	1.2.840.10008.1.2	SCU	None
		Explicit VR, Little Endian	1.2.840.10008.1.2.1	SCU	None

4.2.1.3.1.3. SOP Specific Conformance for Print

The general behavior of the SCU AE during communication failure is summarized in the table below. This behavior is common to all print SOP Classes supported by the SCU AE. The number of seconds to wait for a response from the remote Print AE before timing out is configurable (default=30). The SCU AE retries a configurable number of times (default=30) after a response timeout.

Table 4.2.1-5 – Print Command Communication Failure Behavior

Exception	Behavior
Timeout	The SCU AE releases the association, and the error is recorded in a user-accessible log.
Association rejected or aborted by SCP	The error is recorded in a user-accessible log.

The SCU AE provides baseline conformance. The SCU AE uses 12-bit grayscale images for print if supported by the remote Print AE. 8-bit grayscale is used otherwise. This section describes the DIMSE services and the attributes supported for various remote Print AEs.

4.2.1.3.1.3.1. Specific Conformance to Basic Film Session SOP Class

Table 4.2.1-6 – Basic Film Session SOP Class: Supported DIMSE Operations

Name	Description
N-CREATE	Creates the film session
N-ACTION	Prints the film session
N-DELETE	Deletes the film session

Table 4.2.1-7 – Basic Film Session SOP Class: Supported Attributes

Attribute Name	Tag	Supported Values	Default Value
Number Of Copies	(2000,0010)	1	1
Print Priority	(2000,0020)	MED	MED
Medium Type	(2000,0030)	BLUE FILM CLEAR FILM MAMMO BLUE FILM PAPER	Predefined per Printer

The behavior of the SCU AE when encountering status codes in the N-CREATE, N-ACTION or N-DELETE response is summarized in the table below.

Table 4.2.1-8 – Film Session SOP Class Response Status Handling Behavior

Service Status	Further Meaning	Error Code	Behavior
Success	Success	0000	The remote Print AE has completed the operation successfully. Proceed to next step.
Warning	Any	Any	If relaxed error handling is enabled, proceed to next step as if successful. If not, the SCU AE releases the association and the error is recorded in a user-accessible log.
Failure	Any	Any	The SCU AE releases the association, and the error is recorded in a user-accessible log.

4.2.1.3.1.3.2. Specific Conformance to Basic Film Box SOP Class

Table 4.2.1-9 – Basic Film Box SOP Class: Supported DIMSE Operations

Name	Description
N-CREATE	Creates the film box

Table 4.2.1-10 – Basic Film Box SOP Class: Supported Attributes

Attribute Name	Tag	Supported Values	Default Value
Image Display Format	(2010,0010)	STANDARD\1,1	STANDARD\1,1
Film Orientation	(2010,0040)	PORTRAIT LANDSCAPE	
Film Size ID	(2010,0050)	8INX10IN 10INX12IN 10INX10IN 10INX14IN 11INX14IN 14INX14IN 14INX17IN (Configurable per printer)	Configured per each printer's requirements with image matrix size, or set to calculate automatically for true size printing
Magnification Type	(2010,0060)	CUBIC	CUBIC
Border Density	(2010,0100)	BLACK	BLACK
Empty Image Density	(2010,0110)	BLACK	BLACK
Min Density	(2010,0120)	Configurable per printer	Predefined per Printer
Max Density	(2010,0130)	Configurable per printer	Predefined per Printer
Trim	(2010,0140)	NO	NO
Configuration Information	(2010,0150)	Configurable per printer	Predefined per Printer
Illumination	(2010,015E)	Configurable per printer, sent only if Presentation LUT is sent	5000
Reflected Ambient Light	(2010,0160)	Configurable per printer, sent only if Presentation LUT is sent	10
Referenced Film Session Sequence	(2010,0500)	One sequence Item identifies the film session for this film box	
Referenced Presentation LUT Sequence	(2050,0500)	One sequence Item identifies the Presentation LUT for this film box, sent only if Presentation LUT is sent	
Referenced Image Box Sequence	(2010,0510)	Returned by the printer	

The behavior of the SCU AE when encountering status codes in the N-CREATE response is summarized in the table below.

Table 4.2.1-11 – Film Box SOP Class Response Status Handling Behavior

Service Status	Further Meaning	Error Code	Behavior
Success	Success	0000	The remote Print AE has completed the operation successfully. Proceed to next step.
Warning	Any	Any	If relaxed error handling is enabled, proceed to next step as if successful. If not, the SCU AE releases the association and the error is recorded in a user-accessible log.
Failure	Any	Any	The SCU AE releases the association, and the error is recorded in a user-accessible log.

4.2.1.3.1.3.3. Specific Conformance to Basic Grayscale Image Box SOP Class

Table 4.2.1-12 – Basic Grayscale Image Box SOP Class: Supported DIMSE Operations

Name	Description
N-SET	Updates an image box in a previously created film box.

Table 4.2.1-13 – Basic Grayscale Image Box SOP Class: Supported Attributes

Attribute Name	Tag	Supported Values	Default Value
Image Box Position	(2020,0010)	1	1
Basic Grayscale Image Sequence	(2020,0110)		
> Samples Per Pixel	(0028,0002)	1	1
> Photometric Interpretation	(0028,0004)	MONOCHROME2	MONOCHROME2
> Rows	(0028,0010)	Per printed image	
> Columns	(0028,0011)	Per printed image	
> Pixel Aspect Ratio	(0028,0034)	1\1	1\1
> Bits Allocated	(0028,0100)	8 or 16	
> Bits Stored	(0028,0101)	8 or 12	
> High Bit	(0028,0102)	7 or 11	
> Pixel Representation	(0028,0103)	0	0
> Pixel Data	(7FE0,0010)	Per printed image	
Configuration Information	(2010,0150)	Configurable per printer	Predefined per Printer
Magnification Type	(2010,0060)	CUBIC	CUBIC
Requested Image Size	(2020,0030)	For diagnostic print, set to desired width per printer	Predefined per Printer

The behavior of the SCU AE when encountering status codes in the N-SET response is summarized in the table below:

Table 4.2.1-14 – Image Box SOP Class N-SET Response Status Handling Behavior

Service Status	Further Meaning	Error Code	Behavior
Success	Success	0000	The remote Print AE has completed the operation successfully. Proceed to next step.
Warning	Any	Any	If relaxed error handling is enabled, proceed to next step as if successful. If not, the SCU AE releases the association and the error is recorded in a user-accessible log.
Failure	Any	Any	The SCU AE releases the association, and the error is recorded in a user-accessible log.

4.2.1.3.1.3.4. Specific Conformance to Presentation LUT SOP Class

Table 4.2.1-15 – Presentation LUT SOP Class: Supported DIMSE operations

Name	Description
N-CREATE	Creates a Presentation LUT to be referenced by a film box

4. Networking

Table 4.2.1-16 – Presentation LUT SOP Class: Supported Attributes

Attribute Name	Tag	Supported Values	Default Value
Presentation LUT Shape	(2050,0020)	IDENTITY LIN OD	Configurable per printer

The behavior of the SCU AE when encountering status codes in the N-CREATE response is summarized in the table below:

Table 4.2.1-17 – Presentation LUT SOP Class N-CREATE Response Status Handling Behavior

Service Status	Further Meaning	Error Code	Behavior
Success	Success	0000	The remote Print AE has completed the operation successfully. Proceed to next step.
Warning	Any	Any	If relaxed error handling is enabled, proceed to next step as if successful. If not, the SCU AE releases the association and the error is recorded in a user-accessible log.
Failure	Any	Any	The SCU AE releases the association, and the error is recorded in a user-accessible log.

4.2.1.3.1.3.5. Specific Conformance to Printer SOP Class

Table 4.2.1-18 – Printer SOP Class: Supported DIMSE operations

Name	Description
N-EVENT-REPORT	Receives status notification.
N-GET	Retrieves an instance of a physical printer.

- N-EVENT-REPORT requests are accepted up until the Film Session N-DELETE response is received.
- In the N-GET request, the SCU AE requests Printer Status, Printer Status Info, Printer Name, Manufacturer and Manufacturer's Model Name.
- The behavior of the SCU AE when encountering status codes in the N-GET response is summarized in the table below:

Table 4.2.1-19 – Printer SOP Class N-GET Response Status Handling Behavior

Service Status	Further Meaning	Error Code	Behavior
Success	Success	0000	If Printer Status returned is NORMAL, proceed to next step. If not, the SCU AE releases the association and the error is recorded in a user-accessible log.
Warning	Any	Any	If relaxed error handling is enabled and Printer Status is NORMAL, proceed to next step as if successful. If not, the SCU AE releases the association and the error is recorded in a user-accessible log.
Failure	Any	Any	The SCU AE releases the association, and the error is recorded in a user-accessible log.

4.2.1.3.2. Send Notice

4.2.1.3.2.1. Description and Sequencing of Activities

Send Notice is triggered when a radiologic technologist user creates markings, annotations, and/or measurements on one or more images and requests Send Notice, for all images or a selected image, to one or more remote AEs. The SCU AE negotiates a separate association with each selected remote Store AE to send each Notice. The SCU AE releases each association upon completion of the storage request.

4.2.1.3.2.2. Proposed Presentation Contexts

The SCU AE attempts to establish associations using the following presentation contexts:

Table 4.2.1-20 – Proposed Presentation Contexts for Send Notice

Presentation Context Table					
Abstract Syntax		Transfer Syntax		Role	Extended Negotiation
Name	UID	Name List	UID List		
Grayscale Softcopy Presentation State Storage	1.2.840.10008.5.1.4.1.1.11.1	Implicit VR, Little Endian	1.2.840.10008.1.2	SCU	None
		Explicit VR, Little Endian	1.2.840.10008.1.2.1	SCU	None

4.2.1.3.2.3. SOP Specific Conformance for Storage

The behavior of the SCU AE when encountering status codes in a C-STORE response is summarized in the table below.

Table 4.2.1-21 – C-STORE Response Status Handling Behavior

Service Status	Further Meaning	Error Code	Behavior
Success	Success	0000	The remote Store SCP has successfully stored the SOP Instance. Job complete.
Warning or Failure	Any	Any	The SCU AE releases the association, and the error is reported to the user.

The behavior of the SCU AE during communication failure is summarized in the table below. A failed store request is automatically retried a configurable number of times before reporting failure.

Table 4.2.1-22 – Storage Communication Failure Behavior

Exception	Behavior
Timeout	The SCU AE releases the association, and the error is reported to the user.
Association rejected or aborted by SCP	The error is reported to the user.

Instance UIDs are globally unique for all SOP instances generated by the SCU AE. The UID root is '1.2.276.0.28.3'.

The SCU AE provides standard conformance to the Grayscale Softcopy Presentation State Storage SOP Class. Based on which Send Notice method the user selects, a Notice GSPS instance contains the markings, annotations and measurements made by the radiologic technologist on all of the patient's images, or a selected image.

4.2.1.3.3. Echo Request

4.2.1.3.3.1. Description and Sequencing of Activities

From the DICOM configuration dialog, the service user requests an Echo to test DICOM communication with a configured remote AE. The SCU AE issues a C-ECHO request to the remote AE, and provides the response to the user interface.

4.2.1.3.3.2. Proposed Presentation Contexts

The SCU AE attempts to establish associations using the following presentation contexts:

Table 4.2.1-23 – Proposed Presentation Contexts for Echo Request

Presentation Context Table					
Abstract Syntax		Transfer Syntax		Role	Extended Negotiation
Name	UID	Name List	UID List		
Verification	1.2.840.10008.1.1	Implicit VR, Little Endian	1.2.840.10008.1.2	SCU	None
		Explicit VR, Little Endian	1.2.840.10008.1.2.1	SCU	None

4.2.1.3.3.3. SOP Specific Conformance for Verification

The SCU AE provides baseline conformance. The behavior of the SCU AE when encountering status codes in a C-ECHO response is summarized in the table below.

Table 4.2.1-24 – Verification C-ECHO Response Status Handling Behavior

Service Status	Further Meaning	Error Code	Behavior
Success	Success	0000	Success is reported to the user.

The behavior of the SCU AE during communication failure is summarized in the table below.

Table 4.2.1-25 – Verification Communication Failure Behavior

Exception	Behavior
Timeout	The SCU AE releases the association, and the error is reported to the user.
Association rejected or aborted by remote AE	The error is reported to the user.

4.2.1.3.4. Search on PACS / Auto-Fetch Priors

4.2.1.3.4.1. Description and Sequencing of Activities

Search on PACS is triggered by user interaction. The user may enter matching keys that the SCU AE uses to query a selected remote Query/Retrieve AE using the C-FIND operation. The SCU AE then displays a list of patient studies, series or instances returned in the C-FIND responses. The user may select one or more patient studies, series or instances from the list to retrieve, which signals the SCU AE to generate a C-MOVE request to the remote Query/Retrieve AE, specifying the SCP AE as the move destination. The instances received are made available for the user to view on the SecurView RT workstation.

The default Search on PACS behavior is for the SCU AE to send an initial Study Root, Study Level hierarchical query, followed by Study Root, Series Level hierarchical queries for each study returned. Matching responses are displayed to the user at the series level. The default retrieve behavior is to send a Study Root, Series Level hierarchical move request for each selected patient series. Alternate behavior can be configured such that only Study Level hierarchical queries and retrieves are performed. Alternate behavior can be configured such that Study, Series, and Instance Level hierarchical queries with Instance level retrieves are performed.

When configured as enabled, Auto-Fetch Priors is triggered when the first newly captured digital mammography image for a patient is received. The SCU AE performs C-FIND and C-MOVE operations in the background with a predefined remote Query/Retrieve AE. The default behavior is to send a Study Root, Study Level hierarchical query for the patient identified in the received image. Based on the configured Auto-Fetch Query/Retrieve level (Study, Series, or Image), the SCU AE may send follow-up Study Root, Series Level and Study Root, Image Level hierarchical queries to the remote Query/Retrieve AE. Based on the configured Auto-Fetch Query/Retrieve level, Studies, Series, or Instances are retrieved

one at a time via Study Root, configured level hierarchical move request. If a remote Query/Retrieve AE does not support Image Level C-FIND or C-MOVE, it is configurable to stop at the Series Level C-FIND and perform Series Level C-MOVE. If a remote Query/Retrieve AE does not support Series Level C-FIND or C-MOVE, and the remote Query/Retrieve AE supports Modalities in Study (0008,0061) as a C-FIND return key, it is configurable to stop at the Study Level C-FIND and perform Study Level C-MOVE. The default Auto-Fetch Query/Retrieve level is Series.

For each Search on PACS or Auto-Fetch Priors occurrence, the SCU AE negotiates one association within which all configured levels of C-FIND requests are sent. The SCU AE negotiates a separate consecutive association for each C-MOVE request.

4.2.1.3.4.2. Proposed Presentation Contexts

The SCU AE attempts to establish associations using the following presentation contexts:

Table 4.2.1-26 – Proposed Presentation Contexts for Search on PACS

Presentation Context Table					
Abstract Syntax		Transfer Syntax		Role	Extended Negotiation
Name	UID	Name List	UID List		
Study Root Query/Retrieve Information Model – FIND	1.2.840.10008.5.1.4.1.2.2.1	Implicit VR, Little Endian	1.2.840.10008.1.2	SCU	None
		Explicit VR, Little Endian	1.2.840.10008.1.2.1	SCU	None
Study Root Query/Retrieve Information Model – MOVE	1.2.840.10008.5.1.4.1.2.2.2	Implicit VR, Little Endian	1.2.840.10008.1.2	SCU	None
		Explicit VR, Little Endian	1.2.840.10008.1.2.1	SCU	None

4.2.1.3.4.3. SOP Specific Conformance for Query/Retrieve

The behavior of the SCU AE when encountering status codes in a C-FIND or C-MOVE response is summarized in the table below. For Auto-Fetch Priors, a failed request is retried automatically a predefined number of times before reporting failure.

Table 4.2.1-27 – C-FIND and C-MOVE Response Status Handling Behavior

Service Status	Further Meaning	Error Code	Behavior
Success	Matching or sub-operations are complete	0000	The remote SCP has successfully returned all matching information, or all sub-operations are complete. For C-FIND, perform follow-up query or move, or display results to the user. For C-MOVE, success is reported to the user either in the Search on PACS dialog or the patient list.
Pending	Matches or sub-operations are continuing	FF00	For C-FIND, the matching query result contained in the Identifier is collected for display or automated follow-up. For C-MOVE, the SCU AE continues to wait for additional messages.
Warning or Failure	Any	Any	The SCU AE releases the association. For Search on PACS C-FIND, failure is reported to the user in a status bar in the Search on PACS dialog. For Auto-Fetch Priors C-FIND, failure is reported to the user in the patient list. For C-MOVE, failure is reported to the user either in the Search on PACS dialog or the patient list.

4. Networking

The behavior of the SCU AE during communication failure is summarized in the following table. For Auto-Fetch Priors, a failed request is retried automatically a predefined number of times before reporting failure.

Table 4.2.1-28 – C-FIND and C-MOVE Communication Failure Behavior

Exception	Behavior
Timeout	The SCU AE releases the association. For Search on PACS C-FIND, failure is reported to the user in a status bar in the Search on PACS dialog. For Auto-Fetch Priors C-FIND, failure is reported to the user in the patient list. For C-MOVE, failure is reported to the user either in the Search on PACS dialog or the patient list.
Association rejected or aborted by SCP	For Search on PACS C-FIND, failure is reported to the user in a status bar in the Search on PACS dialog. For Auto-Fetch Priors C-FIND, failure is reported to the user in the patient list. For C-MOVE, failure is reported to the user either in the Search on PACS dialog or the patient list.

The SCU AE provides standard conformance to the Study Root Information Model, hierarchical method only. The Relational method is not supported.

For Search on PACS, by default the SCU AE performs Study Level queries with follow-up Series Level queries as needed, and Series Level retrieves. It is possible to configure Study Level only queries and retrieves. It is possible to configure Study, Series, and Instance Level queries with Instance level retrieves.

For Auto-Fetch Priors, by default the SCU AE performs Study Level and Series Level queries, and Series Level retrieves. It is possible to configure Study Level queries and retrieves if Series Level is not supported by the remote Query/Retrieve AE. It is possible to configure Study, Series, and Instance Level queries with Instance Level retrieves.

For Search on PACS, the SCU AE supports query Matching Key Attributes as defined in the following table. The user supplies Matching Key Attribute values, either by manual entry, drop list selection, or date range selection. Wild Card matching is requested only if the user specifies a wild card character during manual entry. It is configurable to omit optional Study level matching key attributes (Modalities in Study, Referring Physician's Name, Study Description, Patient's Birth Date, Patient's Sex) individually. It is configurable to omit optional Series level matching key attributes (Series Description, Body Part Examined, Performed Procedure Step Start Date, Performed Procedure Step Start Time, Request Attributes Sequence, Scheduled Procedure Step ID, Request Attribute Sequence, Requested Procedure ID) individually. It is configurable to omit optional Image (Instance) level matching key attributes (SOP Class UID, Images in Acquisition, Number of Frames, Concept Name Code Sequence, Content Template Sequence) individually. The maximum number of displayed matches for a query is 1000. The association is released after receiving 1000 matching responses.

Table 4.2.1-29 – Supported C-FIND Matching Key Attributes (Search on PACS)

Matching Key Attribute	Tag	Matching Type
Study Level		
Patient's Name	(0010,0010)	Wild Card or Universal Matching
Patient ID	(0010,0020)	Single Value, Wild Card or Universal Matching
Study Date	(0008,0020)	Single Value, Range or Universal Matching
Study Time	(0008,0030)	Range or Universal Matching
Accession Number	(0008,0050)	Single Value, Wild Card or Universal Matching
Modalities in Study	(0008,0061)	Single Value, Wild Card or Universal Matching; used only if alternate Study Level only query is configured (Optional)

Matching Key Attribute	Tag	Matching Type
Study ID	(0020,0010)	Single Value or Wild Card Matching
Study Instance UID	(0020,000D)	Single Value or Universal Matching
Referring Physician's Name	(0008,0090)	Wild Card or Universal Matching (Optional)
Study Description	(0008,1030)	Universal Matching (Optional)
Patient's Birth Date	(0010,0030)	Single Value or Universal Matching (Optional)
Patient's Sex	(0010,0040)	Universal Matching (Optional)
Series Level		
Study Instance UID	(0020,000D)	Single Value Matching (from Study level result)
Series Instance UID	(0020,000E)	Single Value or Universal Matching
Series Number	(0020,0011)	Single Value or Universal Matching
Modality	(0008,0060)	Single Value, Wild Card or Universal Matching
Series Description	(0008,103E)	Universal Matching (Optional)
Body Part Examined	(0018,0015)	Single Value or Universal Matching (Optional)
Performed Procedure Step Start Date	(0040,0244)	Single Value, Range or Universal Matching (Optional)
Performed Procedure Step Start Time	(0040,0245)	Range or Universal Matching (Optional)
Request Attributes Sequence	(0040,0275)	Sequence or Universal Matching (Optional)
>Scheduled Procedure Step ID	(0040,0009)	Single Value or Universal Matching (Optional)
>Requested Procedure ID	(0040,1001)	Single Value or Universal Matching (Optional)
Image (Instance) Level		
Study Instance UID	(0020,000D)	Single Value Matching (from Study level result)
Series Instance UID	(0020,000E)	Single Value Matching (from Series level result)
Instance Number	(0020,0013)	Single Value or Universal Matching
SOP Instance UID	(0008,0018)	Single Value or Universal Matching
SOP Class UID	(0008,0016)	Universal Matching (Optional)
Images in Acquisition	(0020,1002)	Universal Matching (Optional)
Number of Frames	(0028,0008)	Universal Matching (Optional)
Concept Name Code Sequence	(0040,A043)	Sequence or Universal Matching (Optional)
>Code Value	(0008,0100)	Universal Matching (Optional)
>Coding Scheme Designator	(0008,0102)	Universal Matching (Optional)
>Code Meaning	(0008,0104)	Universal Matching (Optional)
Content Template Sequence	(0040,A504)	Sequence or Universal Matching (Optional)
>Mapping Resource	(0008,0105)	Universal Matching (Optional)
>Template Identifier	(0040,DB00)	Universal Matching (Optional)

For Auto-Fetch Priors, the SCU AE requires the remote Query/Retrieve SCP to support query Matching Key Attributes as defined in the following table.

Table 4.2.1-30 – Supported C-FIND Matching Key Attributes (Auto-Fetch Priors)

Matching Key Attribute	Tag	Matching Type
Study Level		
Patient ID	(0010,0020)	Single Value Matching
Patient's Name	(0010,0010)	Universal Matching
Study Date	(0008,0020)	Universal Matching

4. Networking

Matching Key Attribute	Tag	Matching Type
Study Instance UID	(0020,000D)	Universal Matching
Study ID	(0020,0010)	Universal Matching
Modalities in Study	(0008,0061)	Universal Matching (sent only if Auto-Fetch level is set to Study)
Series Level		
Study Instance UID	(0020,000D)	Single Value Matching (from Study level result)
Series Instance UID	(0020,000E)	Universal Matching
Series Number	(0020,0011)	Universal Matching
Modality	(0008,0060)	Universal Matching
Image Level		
Study Instance UID	(0020,000D)	Single Value Matching (from Study level result)
Series Instance UID	(0020,000E)	Single Value Matching (from Series level result)
SOP Instance UID	(0008,0018)	Universal Matching

4.2.1.4. Association Acceptance Policy

The SCU AE does not accept associations.

4.2.2. SCP AE

4.2.2.1. SOP Classes

The SCP AE provides Standard Conformance to the following SOP Classes:

Table 4.2.2-1 – SOP Classes for SCP AE

SOP Class Name	SOP Class UID	SCU	SCP
Computed Radiography Image Storage	1.2.840.10008.5.1.4.1.1.1	No	Yes
Digital X-Ray Image Storage – For Presentation	1.2.840.10008.5.1.4.1.1.1.1	No	Yes
Digital Mammography X-Ray Image Storage – For Presentation	1.2.840.10008.5.1.4.1.1.1.2	No	Yes
Digital Mammography X-Ray Image Storage – For Processing	1.2.840.10008.5.1.4.1.1.1.2.1	No	Yes
Breast Tomosynthesis Image Storage	1.2.840.10008.5.1.4.1.1.13.1.3	No	Yes
Secondary Capture Image Storage	1.2.840.10008.5.1.4.1.1.7	No	Yes
Multi-frame Grayscale Byte Secondary Capture Image Storage	1.2.840.10008.5.1.4.1.1.7.2	No	Yes
Multi-frame Grayscale Word Secondary Capture Image Storage	1.2.840.10008.5.1.4.1.1.7.3	No	Yes
Multi-frame True Color Secondary Capture Image Storage	1.2.840.10008.5.1.4.1.1.7.4	No	Yes
Ultrasound Image Storage	1.2.840.10008.5.1.4.1.1.6.1	No	Yes
Ultrasound Multi-frame Image Storage	1.2.840.10008.5.1.4.1.1.3.1	No	Yes
Ultrasound Image Storage (Retired)	1.2.840.10008.5.1.4.1.1.6	No	Yes
Ultrasound Multi-frame Image Storage (Retired)	1.2.840.10008.5.1.4.1.1.3	No	Yes
CT Image Storage	1.2.840.10008.5.1.4.1.1.2	No	Yes
Mammography CAD SR Storage	1.2.840.10008.5.1.4.1.1.88.50	No	Yes
Grayscale Softcopy Presentation State Storage	1.2.840.10008.5.1.4.1.1.11.1	No	Yes
Verification SOP Class	1.2.840.10008.1.1	No	Yes

4.2.2.2. Association Policies

4.2.2.2.1. General

The DICOM standard Application context shall be specified.

Table 4.2.2-2 – DICOM Application Context

Application Context Name	1.2.840.10008.3.1.1.1
--------------------------	-----------------------

4.2.2.2.2. Number of Associations

The SCP AE supports multiple associations. There are no enforced limits for the number of open associations.

4.2.2.2.3. Asynchronous Nature

The SecurView RT workstation does not support asynchronous operations (multiple outstanding transactions over a single Association).

4.2.2.2.4. Implementation Identifying Information

Table 4.2.2-3 – DICOM Implementation Class and Version for SCP AE

Implementation Class UID	1.2.276.0.28.3.0.12.900000
Implementation Version Name	MBC_SCR_0900000

4.2.2.3. Association Initiation Policy

The SCP AE does not initiate associations.

4.2.2.4. Association Acceptance Policy

When the SCP AE accepts an association, it will respond to storage and echo requests.

4.2.2.4.1. Activity – Store Instances

4.2.2.4.1.1. Description and Sequencing of Activities

The SCP AE is always running. Store Instances is triggered when a remote Application Entity requests to store instances to the SCP AE. Expected instances include images of several accepted modalities, Mammography CAD SR, and Grayscale Softcopy Presentation State. The SCP AE stores the instances received so that they can be made available to the user. If a received instance is a duplicate of an existing stored instance it is ignored. Instances remain on the SecurView RT workstation until a configurable maximum storage period is reached, or until they are manually deleted.

4.2.2.4.1.2. Accepted Presentation Contexts

The SCP AE accepts associations using the following presentation contexts:

Table 4.2.2-4 – Acceptable Presentation Contexts for Store Instances

Presentation Context Table					
Abstract Syntax		Transfer Syntax		Role	Extended Negotiation
Name	UID	Name	UID		
Computed Radiography Image Storage	1.2.840.10008.5.1.4.1.1.1	See Table 4.2.2-6		SCP	None
Digital X-Ray Image Storage – For Presentation	1.2.840.10008.5.1.4.1.1.1.1	See Table 4.2.2-6		SCP	None
Digital Mammography X-Ray Image Storage – For Presentation	1.2.840.10008.5.1.4.1.1.1.2	See Table 4.2.2-6		SCP	None
Digital Mammography X-Ray Image Storage – For Processing	1.2.840.10008.5.1.4.1.1.1.2.1	See Table 4.2.2-6		SCP	None
Breast Tomosynthesis Image Storage	1.2.840.10008.5.1.4.1.1.13.1.3	See Table 4.2.2-6		SCP	None
Secondary Capture Image Storage	1.2.840.10008.5.1.4.1.1.7	See Table 4.2.2-6		SCP	None
Multi-frame Grayscale Byte Secondary Capture Image Storage	1.2.840.10008.5.1.4.1.1.7.2	See Table 4.2.2-6		SCP	None
Multi-frame Grayscale Word Secondary Capture Image Storage	1.2.840.10008.5.1.4.1.1.7.3	See Table 4.2.2-6		SCP	None
Multi-frame True Color Secondary Capture Image Storage	1.2.840.10008.5.1.4.1.1.7.4	See Table 4.2.2-6		SCP	None
Ultrasound Image Storage	1.2.840.10008.5.1.4.1.1.6.1	See Table 4.2.2-7		SCP	None
Ultrasound Multi-frame Image Storage	1.2.840.10008.5.1.4.1.1.3.1	See Table 4.2.2-7		SCP	None
Ultrasound Image Storage (Retired)	1.2.840.10008.5.1.4.1.1.6	See Table 4.2.2-7		SCP	None
Ultrasound Multi-frame Image Storage (Retired)	1.2.840.10008.5.1.4.1.1.3	See Table 4.2.2-7		SCP	None
CT Image Storage	1.2.840.10008.5.1.4.1.1.2	See Table 4.2.2-6		SCP	None
Mammography CAD SR Storage	1.2.840.10008.5.1.4.1.1.88.50	See Table 4.2.2-5		SCP	None
Grayscale Softcopy Presentation State Storage	1.2.840.10008.5.1.4.1.1.11.1	See Table 4.2.2-5		SCP	None

The SCP AE accepts presentation contexts using the following transfer syntaxes. Presentation contexts containing compression transfer syntaxes can be disabled if necessary:

Table 4.2.2-5 – Acceptable Transfer Syntaxes for Non-Image Instances

Transfer Syntax Table	
Name	UID
Implicit VR Little Endian	1.2.840.10008.1.2
Explicit VR Little Endian	1.2.840.10008.1.2.1

Table 4.2.2-6 – Acceptable Transfer Syntaxes for Image Instances (Except Ultrasound)

Transfer Syntax Table	
Name	UID
JPEG Lossless, Non-Hierarchical, First-Order Prediction (Process 14 [Selection Value 1]): Default Transfer Syntax for Lossless JPEG Image Compression	1.2.840.10008.1.2.4.70
Implicit VR Little Endian	1.2.840.10008.1.2
Explicit VR Little Endian	1.2.840.10008.1.2.1
RLE Lossless	1.2.840.10008.1.2.5

Table 4.2.2-7 – Acceptable Transfer Syntaxes for Ultrasound Image Instances

Transfer Syntax Table	
Name	UID
Implicit VR Little Endian	1.2.840.10008.1.2
Explicit VR Little Endian	1.2.840.10008.1.2.1
JPEG Baseline (Process 1): Default Transfer Syntax for Lossy JPEG 8 Bit Image Compression	1.2.840.10008.1.2.4.50
JPEG Lossless, Non-Hierarchical, First-Order Prediction (Process 14 [Selection Value 1]): Default Transfer Syntax for Lossless JPEG Image Compression	1.2.840.10008.1.2.4.70
RLE Lossless	1.2.840.10008.1.2.5

4.2.2.4.1.3. SOP Specific Conformance for Storage SOP Classes

The SCP AE provides Level 2 (full) conformance to all of the accepted Storage SOP Classes. All received attributes of Type 1, 2, 3, and Private Attributes are stored without modification, and may be used by the SecurView RT workstation. Instances that are stored successfully are not accessible by remote systems.

The SCP AE does not preserve or replace digital signatures.

The SecurView RT workstation does not display MR, CT, NM, or PET images.

The SecurView RT workstation displays Breast Tomosynthesis Image instances produced by Hologic Dimensions. Breast Tomosynthesis Image instances from a specific manufacturer and/or model can be configured to be accepted and discarded if SecurView does not display the reconstructed slices as expected.

The SecurView RT workstation supports display of breast tomosynthesis reconstructed slices received as CT Image.

The SecurView RT workstation supports display of the first DICOM 6000 overlay contained in received images only if the overlay is the same size as the image (see [8.1.2. Usage of Attributes from Received IODs](#)). The DICOM 6000 overlays in images from a specific manufacturer and/or model application can be configured to be ignored if SecurView does not display the overlay content as expected.

The SecurView RT workstation displays Mammography CAD SR instances produced by any manufacturer. Mammography CAD SR instances produced by Hologic, Inc., iCAD, Inc. or VuCOMP, Inc. are displayed according to the manufacturer's guidelines.

The SecurView RT workstation displays the Presentation State Identification and Graphic Annotation module content of any manufacturer's Grayscale Softcopy Presentation State instances (see [8.1.2, Usage of Attributes from Received IODs](#)). All others Presentation State level module content is ignored (e.g., Shutter, Mask, Displayed Area, Graphic Layer, Softcopy VOI LUT). If a received Grayscale Softcopy Presentation State instance does not contain the Graphic Annotation module, it will be accepted and discarded. The Grayscale Softcopy Presentation State instances from a specific manufacturer and/or model application can be configured to be accepted and discarded if SecurView does not display the Graphic Annotation module content as expected.

The SCP AE will behave as described in the table below when generating the C-STORE response.

Table 4.2.2-8 – Storage C-STORE Response Status

Service Status	Further Meaning	Error Code	Reason
Success	Success	0000	Image is stored locally and made available to the user.
Failure	Refused: Out of Resources	A700	There is not enough local storage capacity to store the instance.

4.2.2.4.2. Activity – Receive Echo Request

4.2.2.4.2.1. Description and Sequencing of Activities

The SCP AE is always available to respond to echo requests from any remote Application Entity.

4.2.2.4.2.2. Accepted Presentation Contexts

The SCP AE accepts associations using the following presentation contexts:

Table 4.2.2-9 – Acceptable Presentation Contexts for Receive Echo Request

Presentation Context Table					
Abstract Syntax		Transfer Syntax		Role	Extended Negotiation
Name	UID	Name	UID		
Verification SOP Class	1.2.840.10008.1.1	Implicit VR, Little Endian	1.2.840.10008.1.2	SCP	None
		Explicit VR, Little Endian	1.2.840.10008.1.2.1	SCP	None

4.2.2.4.2.3. SOP Specific Conformance for Verification SOP Class

The SCP AE provides standard conformance to the Verification Service Class.

4.3. Network Interfaces

4.3.1. Physical Network Interface

The SecurView RT workstation is tested and support using 100-BaseT and 1000-BaseT Ethernet media.

4.3.2. Additional Protocols

None.

4.4. Configuration

4.4.1. AE Title/Presentation Address Mapping

A service user configures the SecurView RT workstation’s SCU AE and SCP AE, and remote SCP AEs during site installation, by entering the AE Title, IP Address, and TCP/IP port number for each. When configuring a remote Print AE, a predefined printer specific configuration is also selected. There are no dedicated ports associated with dedicated services.

4.4.2. Configuration Parameters

The following are some of the relevant configurable items for the local and remote AEs:

Table 4.4-1 – Configuration Parameters

Parameter	Configurable (Yes/No)	Default Value
Remote Print AE		
Printer name (manufacturer, model, default film size)	Yes	Per known printer
Configuration info	Yes	Per known printer
Dmin	Yes	Per known printer
Dmax	Yes	Per known printer
Portrait matrix (n x m)	Yes	Per known printer
Landscape matrix (n x m)	Yes	Per known printer
Portrait pixel spacing (n x m)	Yes	Per known printer
Landscape pixel spacing (n x m)	Yes	Per known printer
Bit depth (12 or 8)	Yes	Per known printer
Medium Type (blue film, clear film, mammo blue film, paper)	Yes	Per known printer
Medium Size (8inx10in ,10inx10in, 10inx12in, 10inx14in, 11inx14in, 14inx14in, 14inx17in)	Yes	Per known printer
Printer LUT	Yes	P_to_LIN_at_5000
Print Mode (Standard, Presentation LUT)	Yes	Standard
Luminescence (Presentation LUT mode only)	Yes	5000
Reflected ambient light (Presentation LUT mode only)	Yes	10
Presentation LUT Shape (Presentation LUT mode only)	Yes	IDENTITY
General Parameters		
Number of seconds to wait for association request or release	Yes	30
Number of seconds to wait for reply to association request	Yes	15
Number of seconds to wait for reply to association release	Yes	15
Maximum PDU size the local AE can receive	Yes	28672
Modules that Invoke SCU AE		
Font size for patient info in diagnostic printing	Yes	12
Font size for all other text in diagnostic printing	Yes	10
Font size for annotations in screen capture printing	Yes	18
Relaxed error handling (for print)	Yes	On
Destination(s) for GSPS Notice instances	Yes	None
Number of automatic retries on store before reporting failure	Yes	3
Auto-Fetch Digital Mammography images (On/Off)	Yes	On
Auto-Fetch Hologic Screen Capture images (On/Off)	Yes	Off
Number of priors to auto-fetch	Yes	1
Number of years of priors to auto-fetch	Yes	2
Number of automatic retries on auto-fetch before reporting failure	No	5
Auto-Fetch Q/R Level (Study, Series, Image)	Yes	Series
Search on PACS Q/R Level (, Study, Series, Image)	Yes	Series
Search on PACS sends optional Study level attributes (On/Off)	Yes	On

4. Networking

Parameter	Configurable (Yes/No)	Default Value
Search on PACS optional Study level attributes to send (On/Off)	Yes	Some On, some Off
Search on PACS sends optional Series level attributes (On/Off)	Yes	On
Search on PACS optional Series level attributes to send (On/Off)	Yes	Some On, some Off
Search on PACS sends optional Image level attributes (On/Off)	Yes	On
Search on PACS optional Image level attributes to send (On/Off)	Yes	Some On, some Off
(Search on PACS) Number of minutes to wait for C-FIND / C-MOVE response	Yes	10
(Auto-Fetch) Number of minutes to wait for C-MOVE response	Yes	11
SCP AE		
Auto-Fetch trigger (On/Off)	Yes	Off
Received Mammography CAD SR triggers auto-fetch (On/Off)	Yes	Off
Received GSPS triggers auto-fetch (On/Off)	Yes	Off

5. Media Interchange

5.1. Implementation Model

5.1.1. Application Data Flow Diagram

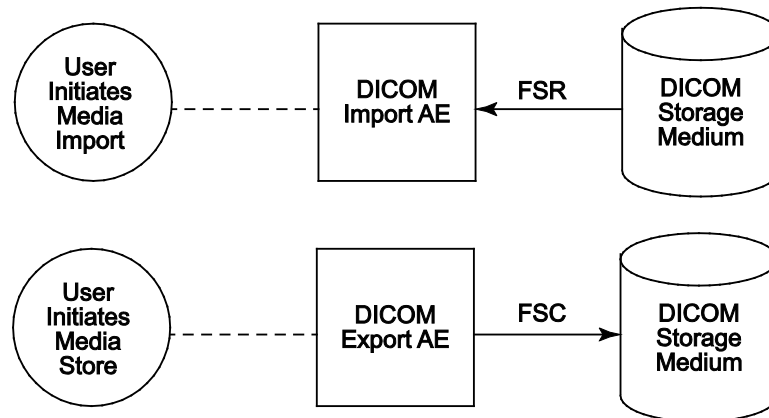

Figure 5.1-1 Application Data Flow Diagram for Media Storage

The DICOM Export AE and DICOM Import AE provide a means to export and import patient images using DICOM Part 10: Media Storage and File Format for Media Interchange. Patient images can be recorded to or read from removable media. These features are provided as a matter of convenience for users to move images from one system to another via removable media. The export feature is not intended to serve as an archive for permanently storing images.

5.1.2. Functional Definition of AEs

The DICOM Export AE can store patient images to removable media.

The DICOM Import AE can read patient images from removable media

The SecurView RT workstation supports DICOM Media Storage as FSC and FSR.

5.1.3. Sequencing of Real-world Activities

The SecurView RT workstation Patient List provides a context menu item to export all images and related objects for selected patients to the selected removable media drive. The export is performed in the foreground, so the user must wait for completion (or cancel) before initiating another activity in the application.

The SecurView RT workstation Patient List has an Import button to select the drive from which to import all detected DICOM files from removable media. The DICOMDIR file is not read. The import is performed in the background, so the user may continue to use the application while the import is in progress (or cancel).

5.1.4. File Meta Information for Implementation Class Version

The implementation information written to the File Meta Header in each file is:

Table 5.1-1 – DICOM Implementation Class and Version for Media Storage

Implementation Class UID	1.2.276.0.28.3.0.12.900000
Implementation Version Name	MBC_SCR_0900000

5.2. AE Specifications

5.2.1. Media Server AE Specification

The DICOM Export AE provides standard conformance to the DICOM Interchange Option of the Media Storage Service Class (SC). The Application Profiles and roles are listed below:

Table 5.2-1 – AE Related Application Profiles, Real-World Activities, and Roles

Supported Application Profile	Real-World Activity	Roles
STD-GEN-CD	User Initiates Media Store	FSC
	User Initiates Media Import	FSR
STD-GEN-DVD-RAM	User Initiates Media Store	FSC
STD-GEN-DVD-JPEG	User Initiates Media Import	FSR
STD-GEN-USB	User Initiates Media Store	FSC
STD-GEN-USB-JPEG	User Initiates Media Import	FSR

5.2.1.1. File Meta Information for Media Server AE

The Source Application Entity Title included in the File Meta Header is local AE Title of the SecurView RT workstation.

5.2.1.2. Real-World Activities

5.2.1.2.1. Activity – User Initiates Media Store

The DICOM Export AE acts as an FSC when requested to export images to removable media.

To store images to removable media, the user selects one or more patients from the Patient List, and then selects the <Export to media> context menu item. All Image, Mammography CAD SR, and Grayscale Softcopy Presentation State Instances that are available locally for the selected patients are stored to the selected removable media drive. Images can be recorded to any removable media, provided the capacity is available to record all Instances for the selected patients.

5.2.1.2.1.1. Media Storage Application Profile

The DICOM Export AE supports the STD-GEN-CD Application Profile. An empty CD is required for each export. Multi-session writes are not supported.

The DICOM Export AE supports the STD-GEN-DVD-RAM Application Profile. An empty DVD is required for each export. Only ISO 9660 is supported, without multi-session writes. UDF is not supported.

The DICOM Export AE supports the STD-GEN-USB Application Profile. If the user selects a folder other than the root for USB export, it is possible for more than one DICOMDIR file to be written to a USB.

5.2.1.2.1.1.1. Options

The DICOM Export AE supports the SOP Classes and Transfer Syntaxes listed in the table below:

Table 5.2-2 – SOP Classes and Transfer Syntaxes for Media Server

SOP Class Name	SOP Class UID	Transfer Syntax	Transfer Syntax UID
Media Storage Directory Storage	1.2.840.10008.1.3.10	Explicit VR Little Endian	1.2.840.10008.1.2.1
Computed Radiography Image Storage	1.2.840.10008.5.1.4.1.1.1	Explicit VR Little Endian	1.2.840.10008.1.2.1
Digital X-Ray Image Storage – For Presentation	1.2.840.10008.5.1.4.1.1.1.1	Explicit VR Little Endian	1.2.840.10008.1.2.1
Digital Mammography X-Ray Image Storage – For Presentation	1.2.840.10008.5.1.4.1.1.1.2	Explicit VR Little Endian	1.2.840.10008.1.2.1

SOP Class Name	SOP Class UID	Transfer Syntax	Transfer Syntax UID
Digital Mammography X-Ray Image Storage – For Processing	1.2.840.10008.5.1.4.1.1.1.2.1	Explicit VR Little Endian	1.2.840.10008.1.2.1
Breast Tomosynthesis Image Storage	1.2.840.10008.5.1.4.1.1.13.1.3	Explicit VR Little Endian	1.2.840.10008.1.2.1
Secondary Capture Image Storage	1.2.840.10008.5.1.4.1.1.7	Explicit VR Little Endian	1.2.840.10008.1.2.1
Multi-frame Grayscale Byte Secondary Capture Image Storage	1.2.840.10008.5.1.4.1.1.7.2	Explicit VR Little Endian	1.2.840.10008.1.2.1
Multi-frame Grayscale Word Secondary Capture Image Storage	1.2.840.10008.5.1.4.1.1.7.3	Explicit VR Little Endian	1.2.840.10008.1.2.1
Multi-frame True Color Secondary Capture Image Storage	1.2.840.10008.5.1.4.1.1.7.4	Explicit VR Little Endian	1.2.840.10008.1.2.1
Ultrasound Image Storage	1.2.840.10008.5.1.4.1.1.6.1	Explicit VR Little Endian	1.2.840.10008.1.2.1
Ultrasound Multi-frame Image Storage	1.2.840.10008.5.1.4.1.1.3.1	Explicit VR Little Endian	1.2.840.10008.1.2.1
Ultrasound Image Storage (Retired)	1.2.840.10008.5.1.4.1.1.6	Explicit VR Little Endian	1.2.840.10008.1.2.1
Ultrasound Multi-frame Image Storage (Retired)	1.2.840.10008.5.1.4.1.1.3	Explicit VR Little Endian	1.2.840.10008.1.2.1
CT Image Storage	1.2.840.10008.5.1.5.1.1.2	Explicit VR Little Endian	1.2.840.10008.1.2.1
Mammography CAD SR Storage	1.2.840.10008.5.1.4.1.1.88.50	Explicit VR Little Endian	1.2.840.10008.1.2.1
Grayscale Softcopy Presentation State Storage	1.2.840.10008.5.1.4.1.1.11.1	Explicit VR Little Endian	1.2.840.10008.1.2.1

5.2.1.2.2. Activity – User Initiates Media Import

The DICOM Import AE acts as an FSR when requested to import images from removable media.

To load images from removable media the user selects the Import button on the Patient List, and then selects a removable media drive. All Image, Mammography CAD SR, and Grayscale Softcopy Presentation State Instances that are detected on the selected removable media drive as DICOM Part 10 files are read and made available to the application.

5.2.1.2.2.1. Media Storage Application Profile

The DICOM Import AE supports the STD-GEN-CD, STD-GEN-DVD-JPEG and STD-GEN-USB-JPEG Application Profiles.

5.2.1.2.2.1.1. Options

The DICOM Import AE supports the SOP Classes and Transfer Syntaxes listed in the table below:

Table 5.2-3 – SOP Classes and Transfer Syntaxes for Media Server

SOP Class Name	SOP Class UID	Transfer Syntax	Transfer Syntax UID
Media Storage Directory Storage	1.2.840.10008.1.3.10	Explicit VR Little Endian	1.2.840.10008.1.2.1
Computed Radiography Image Storage	1.2.840.10008.5.1.4.1.1.1	See Table 4.2.2-6	
Digital X-Ray Image Storage – For Presentation	1.2.840.10008.5.1.4.1.1.1.1	See Table 4.2.2-6	

6. Support of Character Sets

SOP Class Name	SOP Class UID	Transfer Syntax	Transfer Syntax UID
Digital Mammography X-Ray Image Storage – For Presentation	1.2.840.10008.5.1.4.1.1.1.2	See Table 4.2.2-6	
Digital Mammography X-Ray Image Storage – For Processing	1.2.840.10008.5.1.4.1.1.1.2.1	See Table 4.2.2-6	
Breast Tomosynthesis Image Storage	1.2.840.10008.5.1.4.1.1.13.1.3	See Table 4.2.2-6	
Secondary Capture Image Storage	1.2.840.10008.5.1.4.1.1.7	See Table 4.2.2-6	
Multi-frame Grayscale Byte Secondary Capture Image Storage	1.2.840.10008.5.1.4.1.1.7.2	See Table 4.2.2-6	
Multi-frame Grayscale Word Secondary Capture Image Storage	1.2.840.10008.5.1.4.1.1.7.3	See Table 4.2.2-6	
Multi-frame True Color Secondary Capture Image Storage	1.2.840.10008.5.1.4.1.1.7.4	See Table 4.2.2-6	
Ultrasound Image Storage	1.2.840.10008.5.1.4.1.1.6.1	See Table 4.2.2-7	
Ultrasound Multi-frame Image Storage	1.2.840.10008.5.1.4.1.1.3.1	See Table 4.2.2-7	
Ultrasound Image Storage (Retired)	1.2.840.10008.5.1.4.1.1.6	See Table 4.2.2-7	
Ultrasound Multi-frame Image Storage (Retired)	1.2.840.10008.5.1.4.1.1.3	See Table 4.2.2-7	
CT Image Storage	1.2.840.10008.5.1.4.1.1.2	See Table 4.2.2-6	
Mammography CAD SR Storage	1.2.840.10008.5.1.4.1.1.88.50	Explicit VR Little Endian	1.2.840.10008.1.2.1
Grayscale Softcopy Presentation State Storage	1.2.840.10008.5.1.4.1.1.11.1	Explicit VR Little Endian	1.2.840.10008.1.2.1

5.3. Augmented and Private Application Profiles

None.

5.4. Media Configuration

None. The Source AE Title used by the DICOM Export AE is 'MBC SCR'.

6. Support of Character Sets

The SecurView RT workstation supports the following character sets:

- Default: ISO-IR 6
- Latin Alphabet No. 1: ISO-IR 100

7. Security

The SecurView RT workstation does not support any specific DICOM security measures.

It is assumed that the SecurView RT workstation is used within a secured environment. For additional information about Hologic security policies, see Hologic's Enterprise Cybersecurity Best Practices.

8. Annexes

8.1. IOD Contents

8.1.1. Created SOP Instance(s)

Abbreviations for Presence of Value:

- ALWAYS Attribute always present with a value
- ANAP Attribute not always present
- EMPTY Attribute is sent without a value (zero length)
- VNAP Attribute value not always present (zero length if no value is present)

Abbreviations for Source:

- AUTO Attribute value is generated automatically
- CONFIG Attribute value source is a configurable parameter
- MWL Attribute value is the same as the value received using Modality Worklist
- USER Attribute value source is from User input

8.1.1.1. Grayscale Softcopy Presentation State IOD

The attributes that are contained in created GSPS Instances are listed in the following tables.

Table 8.1.1-1 – IOD of Created GSPS SOP Instances

IE	Module	Reference	Presence of Module
Patient	Patient	Table 8.1.1-2	ALWAYS
Study	General Study	Table 8.1.1-3	ALWAYS
	Patient Study	Table 8.1.1-4	ALWAYS
Series	General Series	Table 8.1.1-5	ALWAYS
	Presentation Series	Table 8.1.1-5	ALWAYS
Equipment	General Equipment	Table 8.1.1-6	ALWAYS
Presentation State	Presentation State	Table 8.1.1-7	ALWAYS
	Displayed Area	Table 8.1.1-8	ALWAYS
	Graphic Annotation	Table 8.1.1-9	ANAP
	Graphic Layer	Table 8.1.1-10	ANAP
	Softcopy VOI LUT	Table 8.1.1-11	ALWAYS
	Softcopy Presentation LUT	Table 8.1.1-12	ALWAYS
	SOP Common	Table 8.1.1-13	ALWAYS

8.1.1.2. Grayscale Softcopy Presentation State Modules

Table 8.1.1-2 – Patient Module of Created GSPS Instances

Attribute Name	Tag	Value	Presence of Value	Source
Patient's Name	(0010,0010)	Copied from current patient	ALWAYS	AUTO
Patient ID	(0010,0020)	Copied from current patient	ALWAYS	AUTO
Patient's Birth Date	(0010,0030)	Copied from current patient	VNAP	AUTO
Patient's Sex	(0010,0040)	Copied from current patient	VNAP	AUTO
All other Patient Attributes		Copied from current patient	ANAP	AUTO

Table 8.1.1-3 – General Study Module of Created GSPS Instances

Attribute Name	Tag	Value	Presence of Value	Source
Study Date	(0008,0020)	Copied from current study	ALWAYS	AUTO
Study Time	(0008,0030)	Copied from current study	ALWAYS	AUTO
Accession Number	(0008,0050)	Copied from current study	VNAP	AUTO
Referring Physician's Name	(0008,0090)	Copied from current study	VNAP	AUTO
Study Description	(0008,1030)	Copied from current study	ANAP	AUTO
Study Instance UID	(0020,000D)	Copied from current study	ALWAYS	AUTO
Study ID	(0020,0010)	Copied from current study	VNAP	AUTO
All other Study Attributes		Copied from current study	ANAP	AUTO

Table 8.1.1-4 – Patient Study Module of Created GSPS Instances

Attribute Name	Tag	Value	Presence of Value	Source
Patient's Age	(0010,1010)	Copied from current patient	ANAP	AUTO
All other Patient Study Attributes		Copied from current patient or study	ANAP	AUTO

Table 8.1.1-5 – General & Presentation Series Modules of Created GSPS Instances

Attribute Name	Tag	Value	Presence of Value	Source
Modality	(0008,0060)	PR	ALWAYS	AUTO
Series Instance UID	(0020,000E)	Unique worldwide	ALWAYS	AUTO
Series Number	(0020,0011)	1	ALWAYS	AUTO
Operators' Name	(0008,1070)	Copied from referenced series	ANAP	AUTO
Series Description	(0008,103E)	SecurView GSPS	ALWAYS	AUTO

Table 8.1.1-6 – General Equipment Module of Created GSPS Instances

Attribute Name	Tag	Value	Presence of Value	Source
Manufacturer	(0008,0070)	HOLOGIC, Inc.	ALWAYS	AUTO
Institution Name	(0008,0080)		ALWAYS	CONFIG
Institution Address	(0008,0081)		ANAP	CONFIG
Station Name	(0008,1010)	Local SCU AE Title	ALWAYS	CONFIG
Manufacturer's Model Name	(0008,1090)	SecurView	ALWAYS	AUTO
Software Versions	(0018,1020)	The current software version	ALWAYS	AUTO

Table 8.1.1-7 – Presentation State Module of Created GSPS Instances

Attribute Name	Tag	Value	Presence of Value	Source
Referenced Series Sequence	(0008,1115)	One Item per series on which markings, annotations, measurements were made for the Notice	ALWAYS	AUTO
>Series Instance UID	(0020,000E)		ALWAYS	AUTO
>Referenced Image Sequence	(0008,1140)	One Item per image in referenced series	ALWAYS	AUTO
>>Referenced SOP Class UID	(0008,1150)		ALWAYS	AUTO
>>Referenced SOP Instance UID	(0008,1155)		ALWAYS	AUTO
Instance Number	(0020,0013)	1	ALWAYS	AUTO
Content Label	(0070,0080)	HOLOGIC NOTE	ALWAYS	AUTO
Content Description	(0070,0081)	User name, Date, Time	ALWAYS	AUTO
Presentation Creation Date	(0070,0082)		ALWAYS	AUTO
Presentation Creation Time	(0070,0083)		ALWAYS	AUTO
Content Creator's Name	(0070,0084)	Current user name	ALWAYS	AUTO

Table 8.1.1-8 – Displayed Area Module of Created GSPS Instances

Attribute Name	Tag	Value	Presence of Value	Source
Displayed Area Selection Sequence	(0070,005A)	One Item per image in Referenced Series Sequence	ALWAYS	AUTO
>Referenced Image Sequence	(0008,1140)	One Item per image in referenced series	ALWAYS	AUTO
>>Referenced SOP Class UID	(0008,1150)		ALWAYS	AUTO
>>Referenced SOP Instance UID	(0008,1155)		ALWAYS	AUTO
>Displayed Area Top Left Hand Corner	(0070,0052)	0\0	ALWAYS	AUTO
>Displayed Area Bottom Right Hand Corner	(0070,0053)	Columns\Rows	ALWAYS	AUTO
>Presentation Size Mode	(0070,0100)	SCALE TO FIT	ALWAYS	AUTO
>Presentation Pixel Aspect Ratio	(0070,0102)	1\1	ALWAYS	AUTO

Table 8.1.1-9 – Graphic Annotation Module of Created GSPS Instances

Attribute Name	Tag	Value	Presence of Value	Source
Graphic Annotation Sequence	(0070,0001)	Zero or more Items	ANAP	USER
>Referenced Image Sequence	(0008,1140)	One Item	ALWAYS	AUTO
>>Referenced SOP Class UID	(0008,1150)		ALWAYS	AUTO
>>Referenced SOP Instance UID	(0008,1155)		ALWAYS	AUTO
>>Referenced Frame Number	(0008,1160)	Only if referenced SOP Class is multi-frame	ANAP	AUTO
>Graphic Layer	(0070,0002)	LAYER0	ALWAYS	AUTO
>Text Object Sequence	(0070,0008)	Zero or more Items	ANAP	USER
>>Anchor Point Annotation Units	(0070,0004)	PIXEL	ALWAYS	AUTO
>>Unformatted Text Value	(0070,0006)		ALWAYS	USER
>>Anchor Point	(0070,0014)		ALWAYS	AUTO
>>Anchor Point Visibility	(0070,0015)	N	ALWAYS	AUTO
>Graphic Object Sequence	(0070,0009)	Zero or more Items	ANAP	USER
>>Graphic Annotation Units	(0070,0005)	PIXEL	ALWAYS	AUTO
>>Graphic Dimensions	(0070,0020)	2	ALWAYS	AUTO
>>Number of Graphic Points	(0070,0021)	Depends on Graphic Type	ALWAYS	AUTO
>>Graphic Data	(0070,0022)	Depends on Graphic Type	ALWAYS	USER
>>Graphic Type	(0070,0023)	ELLIPSE or POLYLINE	ALWAYS	USER
>>Graphic Filled	(0070,0024)	N	ALWAYS	AUTO

Table 8.1.1-10 – Graphic Layer Module of Created GSPS Instances

Attribute Name	Tag	Value	Presence of Value	Source
Graphic Layer Sequence	(0070,0060)	One Item, if Graphic Annotation Sequence is present	ANAP	AUTO
>Graphic Layer	(0070,0002)	LAYER0	ALWAYS	AUTO
>Graphic Layer Order	(0070,0062)	1	ALWAYS	AUTO
>Graphic Layer Recommended Display Grayscale Value	(0070,0066)	FFFFH	ALWAYS	AUTO

Table 8.1.1-11 – Softcopy VOI LUT Module of Created GSPS Instances

Attribute Name	Tag	Value	Presence of Value	Source
Softcopy VOI LUT Sequence	(0028,3110)	One Item per image in Referenced Series Sequence. Item will contain either one VOI LUT Sequence Item or one pair of WC/WW values	ANAP	AUTO
>Referenced Image Sequence	(0008,1140)	One Item per image in referenced series	ALWAYS	AUTO
>>Referenced SOP Class UID	(0008,1150)		ALWAYS	AUTO
>>Referenced SOP Instance UID	(0008,1155)		ALWAYS	AUTO
>Window Center	(0028,1050)	Single value, if present	ANAP	USER
>Window Width	(0028,1051)	Single value, if present	ANAP	USER
>VOI LUT Function	(0028,1056)	LINEAR or SIGMOID, if present	ANAP	USER
>VOI LUT Sequence	(0028,3010)	One Item, if present	ANAP	USER
>>LUT Descriptor	(0028,3002)		ANAP	USER
>>LUT Data	(0028,3006)		ANAP	USER

Table 8.1.1-12 – Softcopy Presentation LUT Module of Created GSPS Instances

Attribute Name	Tag	Value	Presence of Value	Source
Presentation LUT Shape	(2050,0020)	IDENTITY or INVERSE	ALWAYS	AUTO

Table 8.1.1-13 – SOP Common Module of Created GSPS Instances

Attribute Name	Tag	Value	Presence of Value	Source
Specific Character Set	(0008,0005)	ISO_IR 100	ALWAYS	AUTO
Instance Creation Date	(0008,0012)	Current date	ALWAYS	AUTO
Instance Creation Time	(0008,0013)	Current time	ALWAYS	AUTO
SOP Class UID	(0008,0016)	Grayscale Softcopy Presentation State Storage	ALWAYS	AUTO
SOP Instance UID	(0008,0018)	Unique worldwide	ALWAYS	AUTO

8.1.2. Usage of Attributes from Received IODs

Attributes with incorrect values may cause undesirable behaviors, or disable certain SecurView RT workstation functionality. In most instances, it is not possible for the SecurView RT workstation software to detect incorrect attribute values.

The following attributes and values are expected for successful interpretation of received SOP Instances.

Table 8.1.2-1 – Expected Attributes in All Received Instances

Attribute Name	Tag	Expected Value
SOP Class UID	(0008,0016)	Matches the Pixel Data
SOP Instance UID	(0008,0018)	Unique worldwide
Study Date	(0008,0020)	Non-zero length
Modality	(0008,0060)	Matches the SOP Class UID when enumerated values are expected
Patient's Name	(0010,0010)	Non-zero length
Patient ID	(0010,0020)	Non-zero length
Patient's Birth Date	(0010,0030)	Zero length accepted
Study Instance UID	(0020,000D)	Unique worldwide
Series Instance UID	(0020,000E)	Unique worldwide

Table 8.1.2-2 – Expected Attributes in All Received Image Instances

Attribute Name	Tag	Expected Value
Patient Orientation	(0020,0020)	Required for automatic hanging of mammography images
Laterality	(0020,0060)	If the anatomy is a paired body part, required for automatic hanging: 'L', 'R', or 'B'
Image Laterality	(0020,0062)	
Samples per Pixel	(0028,0002)	1 or 3
Photometric Interpretation	(0028,0004)	MONOCHROME1, MONOCHROME2, RGB, PALETTE COLOR, YBR_FULL, YBR_FULL_422, or YBR_PARTIAL_422
Planar Configuration	(0028,0006)	Expected with Samples per Pixel > 1
Rows	(0028,0010)	Matches the Pixel Data
Columns	(0028,0011)	Matches the Pixel Data
Pixel Spacing	(0028,0030)	Required to convert measurement units to mm, if Imager Pixel Spacing (0018,1164) is not present
Bits Allocated	(0028,0100)	Up to 16, matches Pixel Data
Bits Stored	(0028,0101)	Up to 16, matches Pixel Data
View Code Sequence	(0054,0220)	Required for automatic hanging of mammography images
>View Modifier Code Sequence	(0054,0222)	Values factored into automatic hanging of mammography images when present
Overlay Rows	(6000,0010)	If present must be same as Rows (0028,0010) value
Overlay Columns	(6000,0011)	If present must be same as Columns (0028,0011) value
Overlay Type	(6000,0040)	If present only G (Graphics) is supported
Overlay Origin	(6000,0050)	If present only 1\1 is supported
Overlay Bits Allocated	(6000,0100)	If present only 1 is permitted
Overlay Bit Position	(6000,0102)	If present only 0 is permitted
Overlay Data	(6000,3000)	If present must have Rows*Columns pixels

Attribute Name	Tag	Expected Value
Pixel Data	(7FE0,0010)	Rows*Columns*(Bits Allocated / 8)*Samples per Pixel

Table 8.1.2-3 – Expected Attributes in Digital Mammography X-Ray Images

Attribute Name	Tag	Expected Value
Presentation Intent Type	(0008,0068)	FOR PRESENTATION or FOR PROCESSING
Manufacturer	(0008,0070)	Manufacturer of the equipment used to create the image
Source Image Sequence	(0008,2112)	FOR PRESENTATION images only, to match with corresponding Mammography CAD SR
>Referenced SOP Class UID	(0008,1150)	Digital Mammography X-Ray Image – For Processing
>Referenced SOP Instance UID	(0008,1155)	SOP Instance UID
Estimated Radiographic Magnification Factor	(0018,1114)	Used in sizing images for display and to convert measurement units to mm
Imager Pixel Spacing	(0018,1164)	Used in sizing images for display and to convert measurement units to mm
Pixel Padding Value	(0028,0120)	Used to maintain black background during W/L interaction
Pixel Padding Range Limit	(0028,0121)	Used to maintain black background during W/L interaction
Window Center	(0028,1050)	Valid values if present
Window Width	(0028,1051)	Valid values if present
VOI LUT Function	(0028,1052)	Used to interpret WC/WC values; default to LINEAR if not present
Rescale Intercept	(0028,1052)	0
Rescale Slope	(0028,1053)	1
Rescale Type	(0028,1054)	US
VOI LUT Sequence	(0028,3010)	Valid values in Items if present

Note: In addition, all other attributes that the IHE Mammography Image profile requires to be made available for display, if present.

Table 8.1.2-4 – Expected Attributes in Hologic Selenia Digital Mammography X-Ray Images

Attribute Name	Tag	Expected Value
Manufacturer	(0008,0070)	'LORAD' or 'HOLOGIC, Inc.'
Private Attributes	(0019,xxxx)	Creator ID = LORAD Selenia

Table 8.1.2-5 – Expected Attributes in Mammography CAD SR Instances

Attribute Name	Tag	Expected Value
Manufacturer	(0008,0070)	'HOLOGIC, Inc.', 'R2 Technology, Inc.', 'CADx', 'iCAD, Inc.' or 'VuCOMP': to display appropriate logo and to display CAD marks according to manufacturer preference
Software Versions	(0018,1020)	Non-zero length value

Table 8.1.2-6 – Supported Content Items in Any Mammography CAD SR Instance

Template	Rows	Expected Value
TID 4000, Mammography CAD Document Root	1-9	All mandatory content items
TID 4001, Mammography CAD Overall Impression/Recommendation	1, 3	All mandatory content items
TID 4003, Mammography CAD Individual Impression/Recommendation	1, 2, 5	All mandatory content items
TID 4006, Mammography CAD Single Image Finding	1-2, 4, 7	
TID 4015, CAD Detections Performed	1-4	All mandatory content items
TID 4016, CAD Analyses Performed	1-4	All mandatory content items
TID 4017, CAD Detection Performed	1, 2, 4	
TID 4018, CAD Analysis Performed	1, 2, 4	
TID 4019, CAD Algorithm Performed	1-3	
TID 4020, CAD Image Library Entry	1-12	All mandatory content items
TID 4021, Mammography CAD Geometry	1-4	Row 3, Outline: POLYLINE, CIRCLE, ELLIPSE

Note: Additional Mammography CAD SR Content Items are supported from the Hologic Cenova server. For additional information, refer to the Cenova DICOM Conformance Statement.

Table 8.1.2-7 – Expected Attributes in Grayscale Softcopy Presentation State Instances

Attribute Name	Tag	Expected Value
Referenced Series Sequence	(0008,1115)	One or more Items
Graphic Annotation Sequence	(0070,0001)	One or more Items, otherwise GSPS is discarded
>Referenced Image Sequence	(0008,1140)	One or more Items if annotations do not apply to all referenced images
>Graphic Layer	(0070,0002)	Ignored, all graphic and text objects are displayed at once
>Text Object Sequence	(0070,0008)	One or more items in Text Object Sequence and/or Graphic Object Sequence
>> Bounding Box Annotation Units	(0070,0003)	PIXEL (DISPLAY is not supported)
>>Anchor Point Annotation Units	(0070,0004)	PIXEL (DISPLAY is not supported)
>>Unformatted Text Value	(0070,0006)	Text is interpreted as ISO-IR 100
>>Bounding Box Top Left Hand Corner	(0070,0010)	
>>Bounding Box Bottom Right Hand Corner	(0070,0011)	
>>Bounding Box Text Horizontal Justification	(0070,0012)	Text will be LEFT aligned (RIGHT and CENTER are not supported)
>>Anchor Point	(0070,0014)	
>>Anchor Point Visibility	(0070,0015)	N (Y is not supported)
>Graphic Object Sequence	(0070,0009)	One or more items in Text Object Sequence and/or Graphic Object Sequence
>>Graphic Annotation Units	(0070,0005)	PIXEL (DISPLAY is not supported)
>>Graphic Dimensions	(0070,0020)	2

Attribute Name	Tag	Expected Value
>>Number of Graphic Points	(0070,0021)	According to Graphic Type
>>Graphic Data	(0070,0022)	According to Graphic Type
>>Graphic Type	(0070,0023)	POINT, POLYLINE, CIRCLE, ELLIPSE is displayed with enclosing circle if major and minor axes are not horizontal and vertical INTERPOLATED is displayed the same as POLYLINE
>>Graphic Filled	(0070,0024)	If Y, then the filling is grayscale value 160 from the range 0..255
Presentation Creation Date	(0070,0082)	Used to identify annotations on display
Presentation Creation Time	(0070,0083)	Used to identify annotations on display
Content Creator's Name	(0070,0084)	Used to identify annotations on display

8.1.3. Attribute Mapping

Not applicable.

8.1.4. Coerced/Modified Attributes

Regarding received Instances, the SecurView RT workstation will attempt to fill in missing attributes and correct invalid attribute values that are required for internal use. All Patient and Study attributes and Referenced SOP Instance UIDs that are copied from received instances to create new instances use the unmodified values as they were received.

If the Referenced SOP Instance UID (0008,1155) within a Source Image Sequence (0008,2112) Item of a Hologic Selenia Digital Mammography – For Presentation image is detected to be incorrect, it is corrected for use within the SecurView RT workstation.

8.2. Data Dictionary of Private Attributes

Private Attributes contained in created Grayscale Softcopy Presentation State SOP Instances do not include patient identification information.

8.3. Coded Terminology and Templates

Not applicable.

8.4. Grayscale Image Consistency

Display calibrations are performed according to the DICOM Grayscale Standard Display Function.

8.5. Standard Extended/Specialized/Private SOP Classes

When communicating with Siemens Magic-Store PACS as a remote Query/Retrieve AE, the SCU AE sends a non-conformant C-MOVE request at the Study Level prior to sending C-MOVE requests at the Series or Image Level. The non-conformant aspect is that (0000,0600) Move Destination is sent zero length. This behavior is expected by Siemens Magic-Store PACS.

8.6. Private Transfer Syntaxes

None.

HOLOGIC®



Hologic Inc.
36 Apple Ridge Road
Danbury, CT 06810 USA



Heron House Oaks Business Park
Crewe Road
Wythenshawe, Manchester
M23 9HZ
UK

Asia Pacific

7th Floor, Biotech Centre 2
No. 11 Science Park West Avenue
Hong Kong Science Park
Shatin, New Territories
Hong Kong

Australia / New Zealand

Suite 402, Level 4
2 Lyon Park Road
Macquarie Park NSW 2113
Australia

CE
0044