

HOLOGIC®



ThinPrep® 5000 Processor with AutoLoader

Operator's Manual



ThinPrep® 5000 Processor with AutoLoader Operator's Manual

HOLOGIC®



Hologic, Inc.
250 Campus Drive
Marlborough, MA 01752 USA
Tel: 1-800-442-9892
1-508-263-2900
Fax: 1-508-229-2795
web: www.hologic.com

Caution: Federal law restricts this device to sale by or on the order of a physician, or any other practitioner licensed by the law of the State in which the practitioner practices to use or order the use of the device and are trained and experienced in the use of the ThinPrep[®] 5000 processor.

Preparation of microscope slides using the ThinPrep 5000 processor should be performed only by personnel who have been trained by Hologic or by organizations or individuals designated by Hologic.

Evaluation of microscope slides produced with the ThinPrep 5000 processor should be performed only by cytotechnologists and pathologists who have been trained to evaluate ThinPrep-prepared slides by Hologic or by organizations or individuals designated by Hologic.

© Hologic, Inc., 2019. All rights reserved. No part of this publication may be reproduced, transmitted, transcribed, stored in a retrieval system, or translated into any language or computer language, in any form, or by any means, electronic, mechanical, magnetic, optical, chemical, manual, or otherwise, without the prior written permission of Hologic, 250 Campus Drive, Marlborough, Massachusetts, 01752, United States of America.

Although this guide has been prepared with every precaution to ensure accuracy, Hologic assumes no liability for any errors or omissions, nor for any damages resulting from the application or use of this information.

This product may be covered by one or more U.S. patents identified at <http://hologic.com/patentinformation>

Hologic, CytoLyt, PreservCyt, ThinPrep, and UroCyt are registered trademarks of Hologic, Inc. and/or its subsidiaries in the United States and/or other countries All other trademarks are the property of their respective companies.

Changes or modifications to this unit not expressly approved by the party responsible for compliance could void the user's authority to operate the equipment.

Document Number: AW-19048-001 Rev. 002



Instructions For Use

Instructions For Use

ThinPrep[®] 5000 Processor

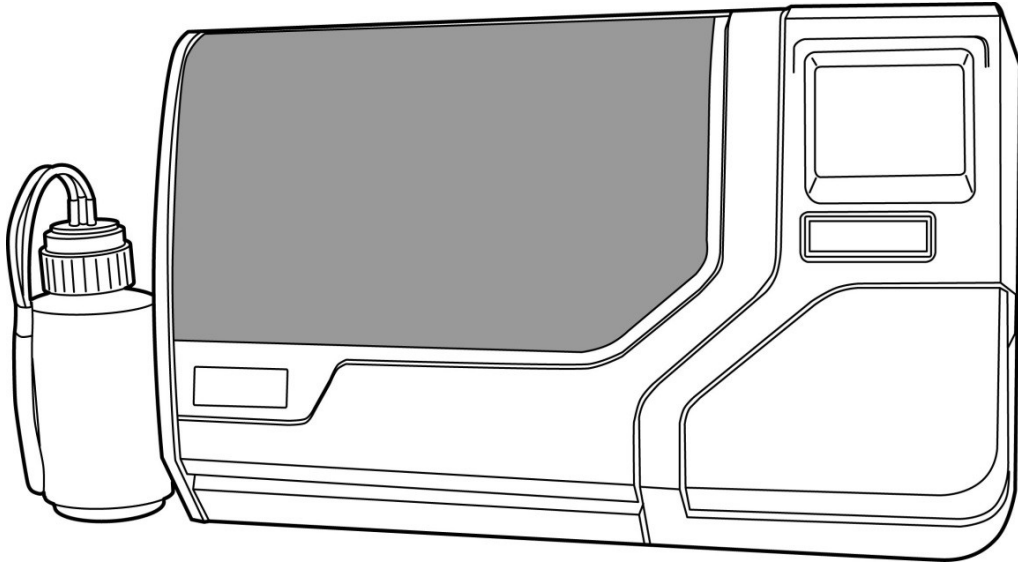

Instructions for Use

HOLOGIC[®]

INTENDED USE

The ThinPrep® 5000 processor is intended as a replacement for the conventional method of Pap smear preparation for use in screening for the presence of atypical cells, cervical cancer, or its precursor lesions (Low-grade Squamous Intraepithelial Lesions, High-grade Squamous Intraepithelial Lesions), as well as all other cytologic categories as defined by The Bethesda System for Reporting Cervical/Vaginal Cytologic Diagnoses¹.

SUMMARY AND EXPLANATION OF THE SYSTEM

The ThinPrep process begins with the patient's gynecologic sample being collected by the clinician using a cervical sampling device which, rather than being smeared on a microscope slide, is immersed and rinsed in a vial filled with 20 mL of PreservCyt® Solution (PreservCyt). The ThinPrep sample vial is then capped, labeled, and sent to a laboratory equipped with a ThinPrep 5000 processor.

At the laboratory, the PreservCyt sample vial is barcoded along with the test request form to establish a sample chain of custody and is placed into a ThinPrep 5000 processor. A glass slide bearing the same sample identification number as on the sample vial is loaded into the processor. A gentle dispersion step mixes the cell sample by currents in the fluid that are strong enough to separate debris and disperse mucus, but gentle enough to have no adverse effect on cell appearance.

The cells are then captured on a gynecological ThinPrep Pap test filter that is specifically designed to collect cells. The ThinPrep 5000 processor constantly monitors the rate of flow through the ThinPrep Pap test filter during the collection process in order to prevent the cellular presentation from being too scant or too dense. A thin layer of cells is then transferred to a glass slide in a 20 mm-diameter circle, and the slide is automatically deposited into a fixative solution.

The ThinPrep Sample Preparation Process

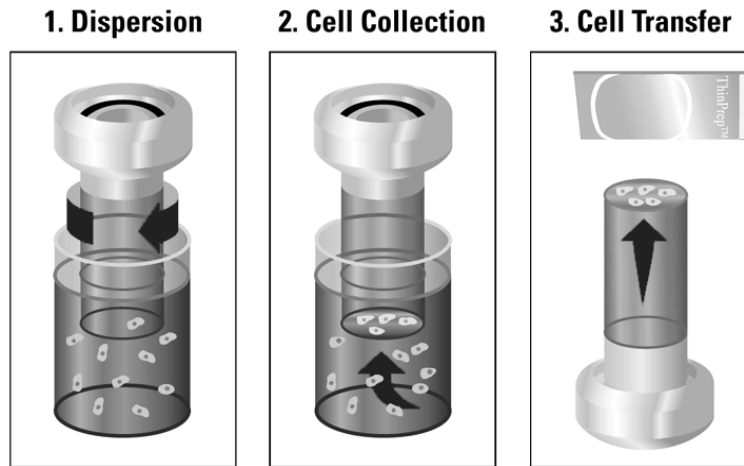

(1) Dispersion

The ThinPrep Pap test filter rotates within the sample vial, creating currents in the fluid that are strong enough to separate debris and disperse mucus, but gentle enough to have no adverse effect on cell appearance.

(2) Cell Collection

A gentle vacuum is created within the ThinPrep Pap test filter, which collects cells on the exterior surface of the membrane. Cell collection is controlled by the ThinPrep 5000 processor's software that monitors the rate of flow through the ThinPrep Pap test filter.

(3) Cell Transfer

After the cells are collected on the membrane, the ThinPrep Pap test filter is inverted and gently pressed against the ThinPrep microscope slide. Natural attraction and slight positive air pressure cause the cells to adhere to the ThinPrep microscope slide resulting in an even distribution of cells in a defined circular area.

As with conventional Pap smears, slides prepared with the ThinPrep[®] 5000 processor are examined in the context of the patient's clinical history and information provided by other diagnostic procedures such as colposcopy, biopsy, and human papillomavirus (HPV) testing, to determine patient management.

The PreservCyt[®] Solution component of the ThinPrep 5000 system is an alternative collection and transport medium for gynecologic specimens tested with Hologic's APTIMA COMBO 2[®] CT/NG Assay and the Digene Hybrid Capture[™] System HPV DNA assay. Refer to the respective manufacturer's package inserts for instructions for using PreservCyt Solution for collection, transport, storage, and preparation of specimens for use in those systems.

The PreservCyt Solution component of the ThinPrep 5000 system is also an alternative collection and transport medium for gynecologic specimens tested with the Roche Diagnostics COBAS AMPLICOR[™] CT/NG assay. Refer to Hologic's labeling (Document #MAN-02063-001) for instructions for using PreservCyt Solution for collection, transport, storage, and preparation of specimens and to the Roche Diagnostics COBAS AMPLICOR CT/NG package insert for instructions for use of that system.

LIMITATIONS

- Gynecologic samples collected for preparation using the ThinPrep 5000 processor should be collected using a broom-type or endocervical brush/plastic spatula combination collection devices. Refer to the instructions provided with the collection device for warnings, contraindications, and limitations associated with specimen collection.
- Preparation of microscope slides using the ThinPrep 5000 processor should be performed only by personnel who have been trained by Hologic or by organizations or individuals designated by Hologic.
- Evaluation of microscope slides produced with the ThinPrep 5000 processor should be performed only by cytotechnologists and pathologists who have been trained to evaluate ThinPrep-prepared slides by Hologic or by organizations or individuals designated by Hologic.
- Supplies used by the ThinPrep 5000 processor are those designed and supplied by Hologic specifically for the ThinPrep 5000 processor. These include PreservCyt Solution vials, ThinPrep Pap test filters, and ThinPrep microscope slides. These supplies are required for proper performance of the system and cannot be substituted. Product performance will be compromised if other supplies are used. After use, supplies should be disposed of in accordance with local, state, and federal regulations.
- A ThinPrep Pap test filter must be used only once and cannot be reused.
- The performance of HPV DNA and CT/NG testing on reprocessed sample vials has not been evaluated.

CONTRAINDICATIONS

- *Chlamydia trachomatis* and *Neisseria gonorrhoeae* testing using the Hologic APTIMA COMBO 2[®] CT/NG assay and the Roche Diagnostics COBAS AMPLICOR assay should not be performed on a sample that has already been processed using the ThinPrep 5000 processor.

WARNINGS

- For In Vitro Diagnostic Use
- Danger. PreservCyt Solution contains methanol. Toxic if swallowed. Toxic if inhaled. Causes damage to organs. Flammable liquid and vapor. Keep away from heat, sparks, open flames and hot surfaces. Other solutions cannot be substituted for PreservCyt Solution. PreservCyt Solution should be stored and disposed of in accordance with all applicable regulations.

PRECAUTIONS

- This equipment generates, uses and can radiate radio frequency energy, and if not installed and used in accordance with the operator's manual, may cause interference to radio communications. Operation of this equipment in a residential area is likely to cause harmful interference, in which case the user will be required to correct the interference at his/her own expense.
- PreservCyt Solution *with* cytologic sample intended for ThinPrep Pap testing must be stored between 15°C (59°F) and 30°C (86°F) and tested within 6 weeks of collection.
- PreservCyt Solution *with* cytologic sample intended for CT/NG testing using the Roche Diagnostics COBAS AMPLICOR CT/NG test must be stored between 4°C (39°F) and 25°C (77°F) and tested within 6 weeks of collection.

- PreservCyt Solution was challenged with a variety of microbial and viral organisms. The following table presents the starting concentrations of viable organisms, and the log reduction of viable organisms found after 15 minutes in the PreservCyt Solution. As with all laboratory procedures, universal precautions should be followed.

Organism	Initial Concentration	Log Reduction After 15 Minutes
<i>Candida albicans</i>	5.5 x 10 ⁵ CFU/mL	>4.7
<i>Aspergillus niger</i> *	4.8 x 10 ⁵ CFU/mL	>2.7
<i>Escherichia coli</i>	2.8 x 10 ⁵ CFU/mL	>4.4
<i>Staphylococcus aureus</i>	2.3 x 10 ⁵ CFU/mL	>4.4
<i>Pseudomonas aeruginosa</i>	2.5 x 10 ⁵ CFU/mL	>4.4
<i>Mycobacterium tuberculosis</i> **	9.4 x 10 ⁵ CFU/mL	>4.9
<i>Rabbitpox virus</i>	6.0 x 10 ⁶ PFU/mL	>5.5***
<i>HIV-1</i>	1.0 x 10 ^{7.5} TCID ₅₀ /mL	>7.0***

* After 1 hour >4.7 log reduction

** After 1 hour >5.7 log reduction

*** Data is for 5 minutes

PERFORMANCE CHARACTERISTICS: REPORT OF CLINICAL STUDIES

The ThinPrep 5000 processor is technologically similar to the ThinPrep 2000 system. The performance characteristics of the ThinPrep 5000 processor are predicated on those of the ThinPrep 2000 system. Both the clinical studies for the ThinPrep 2000 system and those comparing the ThinPrep 5000 processor to the ThinPrep 2000 are described in the following sections.

ThinPrep 2000 System Compared to Conventional Pap Smear

A prospective multi-center clinical study was conducted to evaluate the performance of the ThinPrep 2000 system in direct comparison to the conventional Pap smear. The objective of the ThinPrep clinical study was to demonstrate that gynecologic specimens prepared using the ThinPrep 2000 system were at least as effective as conventional Pap smears for the detection of atypical cells and cervical cancer or its precursor lesions in a variety of patient populations. In addition, an assessment of specimen adequacy was performed.

The initial clinical study protocol was a blinded, split sample, matched pair study, for which a conventional Pap smear was prepared first, and the remainder of the sample (the portion that normally would have been discarded) was immersed and rinsed into a vial of PreservCyt Solution. At the laboratory, the PreservCyt sample vial was placed into a ThinPrep 2000 processor and a slide was then prepared from the patient's sample. ThinPrep and conventional

Pap smear slides were examined and diagnosed independently. Reporting forms containing patient history as well as a checklist of all possible categories of The Bethesda System were used to record the results of the screening. A single independent pathologist reviewed all discrepant and positive slides from all sites in a blinded fashion to provide a further objective review of the results.

Laboratory and Patient Characteristics

Cytology laboratories at three screening centers (designated as S1, S2, and S3) and three hospital centers (designated as H1, H2, and H3) participated in the clinical study. The screening centers in the study serve patient populations (screening populations) with rates of abnormality (Low-grade Squamous Intraepithelial Lesion [LSIL] and more severe lesions) similar to the United States average of less than 5%.² The hospital centers in the study serve a high risk referral patient population (hospital populations) characterized by high rates (>10%) of cervical abnormality. Data on race demographics was obtained for 70% of the patients that participated in the study. The study population consisted of the following race groups: Caucasian (41.2%), Asian (2.3%), Hispanic (9.7%), African American (15.2%), Native American (1.0%) and other groups (0.6%).

Table 1 describes the laboratories and the patient populations.

Table 1: Site Characteristics

Site	Laboratory Characteristics			Clinical Study Demographics			
	Type of Patient Population	Laboratory Volume - Smears per Year	Cases	Patient Age Range	Post-Menopausal	Previous Abnormal Pap Smear	Convent. Prevalence LSIL+
S1	Screening	300,000	1,386	18.0–84.0	10.6%	8.8%	2.3%
S2	Screening	100,000	1,668	18.0–60.6	0.3%	10.7%	2.9%
S3	Screening	96,000	1,093	18.0–48.8	0.0%	7.1%	3.8%
H1	Hospital	35,000	1,046	18.1–89.1	8.1%	40.4%	9.9%
H2	Hospital	40,000	1,049	18.1–84.4	2.1%	18.2%	12.9%
H3	Hospital	37,000	981	18.2–78.8	11.1%	38.2%	24.2%

Clinical Study Results

The diagnostic categories of The Bethesda System were used as the basis of the comparison between conventional and ThinPrep[®] findings from the clinical study. The diagnostic classification data and statistical analyses for all clinical sites are presented in Tables 2 through 11. Cases with incorrect paperwork, patient's age less than 18 years, cytologically unsatisfactory slides, or patients with a hysterectomy were excluded from this analysis. Few cases of cervical cancer (0.02%³) were represented in the clinical study, as is typical in the United States patient population.

Table 2: Diagnostic Classification Table, All Categories

		Conventional							
		NEG	ASCUS	AGUS	LSIL	HSIL	SQ CA	GL CA	TOTAL
ThinPrep	NEG	5224	295	3	60	11	0	0	5593
	ASCUS	318	125	2	45	7	0	0	497
	AGUS	13	2	3	0	1	0	1	20
	LSIL	114	84	0	227	44	0	0	469
	HSIL	11	15	0	35	104	2	0	167
	SQ CA	0	0	0	0	0	1	0	1
	GL CA	0	0	0	0	0	0	0	0
	TOTAL	5680	521	8	367	167	3	1	6747

Abbreviations for Diagnoses: **NEG** = Normal or negative, **ASCUS** = Atypical Squamous Cells of Undetermined Significance, **AGUS** = Atypical Glandular Cells of Undetermined Significance, **LSIL** = Low-grade Squamous Intraepithelial Lesion, **HSIL** = High-grade Squamous Intraepithelial Lesion, **SQ CA** = Squamous Cell Carcinoma, **GL CA** = Glandular Cell Adenocarcinoma

Table 3: Three Category Diagnostic Classification Table

		Conventional			
		NEG	ASCUS/AGUS+	LSIL+	TOTAL
ThinPrep	NEG	5224	298	71	5593
	ASCUS/AGUS+	331	132	54	1154
	LSIL+	125	99	413	637
	TOTAL	5680	529	538	6747

Table 4: Two Category Diagnostic Classification Table, LSIL and More Severe Diagnoses

		Conventional		
		NEG/ASCUS/AGUS+	LSIL+	TOTAL
ThinPrep	NEG/ASCUS/AGUS+	5985	125	6110
	LSIL+	224	413	637
	TOTAL	6209	538	6747

Table 5: Two Category Diagnostic Classification Table, ASCUS/AGUS and More Severe Diagnoses

		Conventional		
		NEG	ASCUS/AGUS+	TOTAL
ThinPrep	NEG	5224	369	5593
	ASCUS/AGUS+	456	698	1154
	TOTAL	5680	1067	6747

The diagnostic data analysis from the sites is summarized in Table 6 and 7. When the *p*-value is significant (*p* < 0.05), the method favored is indicated in the tables.

Table 6: Results by Site, LSIL and More Severe Lesions

Site	Cases	ThinPrep LSIL+	Convent. LSIL+	Increased Detection*	<i>p</i> -Value	Method Favored
S1	1,336	46	31	48%	0.027	ThinPrep
S2	1,563	78	45	73%	<0.001	ThipPrep
S3	1,058	67	40	68%	<0.001	ThinPrep
H1	971	125	96	30%	<0.001	ThinPrep
H2	1,010	111	130	(15%)	0.135	Neither
H3	809	210	196	7%	0.374	Neither

$$*Increased\ detection = \frac{ThinPrep^{\circledR}\ LSIL+ - Conventional\ LSIL+}{Conventional\ LSIL+} \times 100\%$$

For LSIL and more severe lesions, the diagnostic comparison statistically favored the ThinPrep[®] method at four sites and was statistically equivalent at two sites.

Table 7: Results by Site, ASCUS/AGUS and More Severe Lesions

Site	Cases	ThinPrep ASCUS+	Convent. ASCUS+	Increased Detection*	p-Value	Method Favored
S1	1,336	117	93	26%	0.067	Neither
S2	1,563	124	80	55%	<0.001	ThinPrep
S3	1,058	123	81	52%	<0.001	ThinPrep
H1	971	204	173	18%	0.007	ThinPrep
H2	1,010	259	282	(8%)	0.360	Neither
H3	809	327	359	(9%)	0.102	Neither

$$*Increased\ detection = \frac{ThinPrep\ ASCUS+ - Conventional\ ASCUS+}{Conventional\ ASCUS+} \times 100\%$$

For ASCUS/AGUS and more severe lesions, the diagnostic comparison statistically favored the ThinPrep method at three sites and was statistically equivalent at three sites.

One pathologist served as an independent reviewer for the six clinical sites, receiving both slides from cases where the two methods were either abnormal or discrepant. Since a true reference cannot be determined in such studies and therefore true sensitivity cannot be calculated, the use of an expert cytologic review provides an alternative to histologic confirmation by biopsy or human papillomavirus (HPV) testing as a means for determining the reference diagnosis.

The reference diagnosis was the more severe diagnosis from either of the ThinPrep or conventional Pap slides as determined by the independent pathologist. The number of slides diagnosed as abnormal at each site, compared to the reference diagnosis of the independent pathologist, provides the proportion of LSIL or more severe lesions (Table 8) and the proportion of ASCUS/AGUS or more severe lesions (Table 9). The statistical analysis allows a comparison of the two methods and a determination of which method is favored when using the independent pathologist for expert cytologic review as the adjudicator of the final diagnosis.

Table 8: Independent Pathologist Results by Site, LSIL and More Severe Lesions

Site	Cases Positive by Independent Pathologist	ThinPrep Positive	Conventional Positive	p-Value	Method Favored
S1	50	33	25	0.170	Neither
S2	65	48	33	0.042	ThinPrep
S3	77	54	33	<0.001	ThinPrep
H1	116	102	81	<0.001	ThinPrep
H2	115	86	90	0.876	Neither
H3	126	120	112	0.170	Neither

For LSIL and more severe lesions, the diagnostic comparison statistically favored the ThinPrep method at three sites and was statistically equivalent at three sites.

Table 9: Independent Pathologist Results by Site, ASCUS/AGUS and More Severe Lesions

Site	Cases Positive by Independent Pathologist	ThinPrep [®] Positive	Conventional Positive	p-Value	Method Favored
S1	92	72	68	0.900	Neither
S2	101	85	59	0.005	ThinPrep
S3	109	95	65	<0.001	ThinPrep
H1	170	155	143	0.237	Neither
H2	171	143	154	0.330	Neither
H3	204	190	191	1.000	Neither

For ASCUS/AGUS and more severe lesions, the diagnostic comparison statistically favored the ThinPrep method at two sites and was statistically equivalent at four sites.

Table 10 below shows the summary for all sites of the descriptive diagnosis for all Bethesda System categories.

Table 10: Summary of Descriptive Diagnosis

Descriptive Diagnosis	ThinPrep		Conventional	
	N	%	N	%
<i>Number of Patients: 6747</i>				
Benign Cellular Changes:	1592	23.6	1591	23.6
Infection:				
Trichomonas Vaginalis	136	2.0	185	2.7
Candida spp.	406	6.0	259	3.8
Coccobacilli	690	10.2	608	9.0
Actinomyces spp.	2	0.0	3	0.0
Herpes	3	0.0	8	0.1
Other	155	2.3	285	4.2
Reactive Cellular Changes Associated with:				
Inflammation	353	5.2	385	5.7
Atrophic Vaginitis	32	0.5	48	0.7
Radiation	2	0.0	1	0.0
Other	25	0.4	37	0.5
Epithelial Cell Abnormalities:	1159	17.2	1077	16.0
Squamous Cell:				
ASCUS	501	7.4	521	7.7
favor reactive	128	1.9	131	1.9
favor neoplastic	161	2.4	140	2.1
undetermined	213	3.2	250	3.7
LSIL	469	7.0	367	5.4
HSIL	167	2.5	167	2.5
Carcinoma	1	0.0	3	0.0
Glandular Cell:				
Benign Endometrial cells in Postmenopausal Women	7	0.1	10	0.1
Atypical Glandular Cells (AGUS)	21	0.3	9	0.1
favor reactive	9	0.1	4	0.1
favor neoplastic	0	0.0	3	0.0
undetermined	12	0.2	2	0.0
Endocervical	0	0.0	1	0.0
Adenocarcinoma	0	0.0	1	0.0

Note: Some patients had more than one diagnostic subcategory.

Table 11 shows the rates of detection for infection, reactive changes, and the total benign cellular changes for both the ThinPrep® and conventional methods at all sites.

Table 11: Benign Cellular Changes Results

		ThinPrep		Conventional	
		N	%	N	%
Benign Cellular Changes	Infection	1392	20.6	1348	20.0
	Reactive Changes	412	6.1	471	7.0
	Total*	1592	23.6	1591	23.6

* Total includes some patients that may have had both an infection and reactive cellular change.

Tables 12, 13, and 14 show the specimen adequacy results for the ThinPrep method and conventional smear method for all of the study sites. Of the 7,360 total patients enrolled, 7,223 are included in this analysis. Cases with patient's age less than 18 years or patients with a hysterectomy were excluded from this analysis.

Two additional clinical studies were conducted to evaluate specimen adequacy results when samples were deposited directly into the PreservCyt® vial, without first making a conventional Pap smear. This specimen collection technique is the intended use for the ThinPrep 2000 system. Tables 15 and 16 present the split sample and direct to vial results.

Table 12: Summary of Specimen Adequacy Results

Specimen Adequacy	ThinPrep		Conventional	
	N	%	N	%
<i>Number of Patients: 7223</i>				
Satisfactory	5656	78.3	5101	70.6
Satisfactory for Evaluation but Limited by:	1431	19.8	2008	27.8
Air-Drying Artifact	1	0.0	136	1.9
Thick Smear	9	0.1	65	0.9
Endocervical Component Absent	1140	15.8	681	9.4
Scant Squamous Epithelial Component Obscuring	150	2.1	47	0.7
Blood Obscuring	55	0.8	339	4.7
Inflammation No Clinical	141	2.0	1008	14.0
History Cytolysis	12	0.2	6	0.1
Other	19	0.3	119	1.6
	10	0.1	26	0.4
Unsatisfactory for Evaluation:	136	1.9	114	1.6
Air-Drying Artifact	0	0.0	13	0.2
Thick Smear	0	0.0	7	0.1
Endocervical Component Absent	25	0.3	11	0.2
Scant Squamous Epithelial Component Obscuring	106	1.5	47	0.7
Blood Obscuring	23	0.3	58	0.8
Inflammation No Clinical	5	0.1	41	0.6
History Cytolysis	0	0.0	0	0.0
Other	0	0.0	4	0.1
Other	31	0.4	9	0.1

Note: Some patients had more than one subcategory.

Table 13: Specimen Adequacy Results

		Conventional			
		SAT	SBLB	UNSAT	TOTAL
ThinPrep	SAT	4316	1302	38	5656
	SBLB	722	665	44	1431
	UNSAT	63	41	32	136
	TOTAL	5101	2008	114	7223

SAT=Satisfactory, SBLB=Satisfactory But Limited By, UNSAT=Unsatisfactory

Table 14: Specimen Adequacy Results by Site

Site	Cases	ThinPrep SAT Cases	Convent. SAT Cases	ThinPrep SBLB Cases	Convent. SBLB Cases	ThinPrep UNSAT Cases	Convent. UNSAT Cases
S1	1,386	1092	1178	265	204	29	4
S2	1,668	1530	1477	130	178	8	13
S3	1,093	896	650	183	432	14	11
H1	1,046	760	660	266	375	20	11
H2	1,049	709	712	323	330	17	7
H3	981	669	424	264	489	48	68
All Sites	7,223	5656	5101	1431	2008	136	114

The Satisfactory But Limited By (SBLB) category can be broken down into many subcategories, one of which is the absence of Endocervical Component. Table 15 shows the Satisfactory But Limited By category “No ECC’s” for ThinPrep® and conventional slides.

Table 15: Specimen Adequacy Results by Site, SBLB Rates for no Endocervical Component

SBLB Due to No ECC's					
Site	Cases	ThinPrep SBLB- no ECC's	ThinPrep SBLB- no ECC's (%)	Conventional SBLB- no ECC's	Conventional SBLB- no ECC's (%)
S1	1,386	237	17.1%	162	11.7%
S2	1,668	104	6.2%	73	4.4%
S3	1,093	145	13.3%	84	7.7%
H1	1,046	229	21.9%	115	11.0%
H2	1,049	305	29.1%	150	14.3%
H3	981	120	12.2%	97	9.9%
All Sites	7,223	1140	15.8%	681	9.4%

For the results of the clinical study involving a split-sample protocol, there was a 6.4 percent difference between conventional and ThinPrep methods in detecting endocervical component. This is similar to previous studies using a split sample methodology.

Direct-to-vial Endocervical Component (ECC) Studies

For the intended use of the ThinPrep® 2000 system, the cervical sampling device will be rinsed directly into a PreservCyt® vial, rather than splitting the cellular sample. It was expected that this would result in an increase in the pick-up of endocervical cells and metaplastic cells. To verify this hypothesis, two studies were performed using the direct-to-vial method and are summarized in Table 16. Overall, no difference was found between ThinPrep and conventional methods in these two studies.

Table 16: Summary of Direct-to-vial Endocervical Component (ECC) Studies

Study	Number of Evaluable Patients	SBLB due to No Endocervical Component	Comparable Conventional Pap Smear Percentage
Direct-to-Vial Feasibility	299	9.36%	9.43% ¹
Direct-to-Vial Clinical Study	484	4.96%	4.38% ²

1. Direct-to-Vial Feasibility study compared to overall clinical investigation conventional Pap smear SBLB-No Endocervical Component rate.
2. Direct-to-Vial Clinical study compared to site S2 clinical investigation conventional Pap smear SBLB-No Endocervical Component rate.

Direct-to-Vial HSIL+ Study

Following initial FDA approval of the ThinPrep system, Hologic conducted a multi-site direct-to-vial clinical study to evaluate the ThinPrep 2000 system versus conventional Pap smear for the detection of High Grade Squamous Intraepithelial and more severe lesions (HSIL+). Two types of patient groups were enrolled in the trial from ten (10) leading academic hospitals in major metropolitan areas throughout the United States. From each site, one group consisted of patients representative of a routine Pap test screening population and the other group made up of patients representative of a referral population enrolled at the time of colposcopic examination. The ThinPrep specimens were collected prospectively and compared against a historical control cohort. The historical cohort consisted of data collected from the same clinics and clinicians (if available) used to collect the ThinPrep specimens. These data were collected sequentially from patients seen immediately prior to the initiation of the study.

The results from this study showed a detection rate of 511 / 20,917 for the conventional Pap smear versus 399 / 10,226 for the ThinPrep slides. For these clinical sites and these study populations, this indicates a 59.7% increase in detection of HSIL+ lesions for the ThinPrep specimens. These results are summarized in Table 17.

Table 17: Summary of Direct-to-Vial HSIL+ Study

Site	Total CP (n)	HSIL+	Percent (%)	Total TP (n)	HSIL+	Percent (%)	Percent Change (%)
S1	2,439	51	2.1	1,218	26	2.1	+2.1
S2	2,075	44	2.1	1,001	57	5.7	+168.5
S3	2,034	7	0.3	1,016	16	1.6	+357.6
S4	2,043	14	0.7	1,000	19	1.9	+177.3
S5	2,040	166	8.1	1,004	98	9.8	+20.0
S6	2,011	37	1.8	1,004	39	3.9	+111.1
S7	2,221	58	2.6	1,000	45	4.5	+72.3
S8	2,039	61	3.0	983	44	4.5	+49.6
S9	2,000	4	0.2	1,000	5	0.5	+150.0
S10	2,015	69	3.4	1,000	50	5.0	+46.0
Total	20,917	511	2.4	10,226	399	3.9	59.7(p<0.001)

$$\text{Percent Change (\%)} = ((\text{TP HSIL+}/\text{TP Total})/(\text{CP HSIL+}/\text{CP Total}) - 1) * 100$$

Glandular Disease Detection – Published Studies

The detection of endocervical glandular lesions is an essential function of the Pap test. However, abnormal glandular cells in the Pap sample may also originate from the endometrium or from extrauterine sites. The Pap test is not intended to be a screening test for such lesions.

When suspected glandular abnormalities are identified, their accurate classification as true glandular versus squamous lesions is important for proper evaluation and subsequent treatment (*e.g.* choice of excisional biopsy method versus conservative follow-up). Multiple peer-reviewed publications⁴⁻⁹ report on the improved ability of the ThinPrep 2000 system to detect glandular disease versus the conventional Pap smear. Although these studies do not consistently address sensitivity of different Pap testing methods in detecting specific types of glandular disease, the reported results are consistent with more frequent biopsy confirmation of abnormal glandular findings by the ThinPrep Pap test compared to conventional cytology.

Thus, the finding of a glandular abnormality on a ThinPrep Pap test slide merits increased attention for definitive evaluation of potential endocervical or endometrial pathology.

ThinPrep 5000 Processor Compared to ThinPrep 2000 System

A study was conducted to estimate the Positive Percent Agreement (PPA) and Negative Percent Agreement (NPA) for specimens processed on the ThinPrep 5000 processor as compared with processing using the ThinPrep 2000 System.

Clinical Study Design

The study was a prospective, multi-center, split-sample, blinded evaluation of ThinPrep slides of known diagnoses generated from residual cytological specimens. The study was conducted at Hologic, Inc., Marlborough, MA and at two external laboratories in the United States.

One thousand two hundred sixty (1260) specimens were procured for and selected from Hologic's Residual Specimen Inventory for Hologic's laboratory. At the external study sites specimens were from residual cytological specimens from the clinical laboratory (after the laboratory has prepared a slide from the vial and has signed-out the case per standard practice). The laboratory's specimens were only supplemented from Hologic's inventory with the rarest cytologic diagnostic categories (AGUS and Cancer), if needed. Slides prepared for the study were from specimens processed within 6 weeks of specimen collection.

All study specimens were processed both on a ThinPrep 5000 processor and a ThinPrep 2000 system. The order in which the slides were processed was alternated in blocks of 20. All slides were stained, coverslipped, and read manually following standard laboratory procedures; all slides prepared at a site were reviewed independently by each of the three (3) pairs of cytotechnologists/pathologists. All cytologic diagnoses were determined in accordance with the Bethesda System 2001 criteria for all slides¹.

Table 18: Laboratory ThinPrep 5000 Diagnosis vs. Laboratory ThinPrep 2000 Diagnosis for First Pair of Cytotechnologist/Pathologist (Combined Sites)

Lab ThinPrep 5000 Diagnosis	Lab ThinPrep 2000 Diagnosis								
	UNSAT	NILM	ASC-US	AGUS	LSIL	ASC-H	HSIL	Cancer	Total
UNSAT	31	9		1	1				42
NILM	9	624	32	2	4	3	2		676
ASC-US	3	23	59	3	33	10	1		132
AGUS	1	5		7		1	3	3	20
LSIL		6	19	1	111	9	14		160
ASC-H		6	7	2	9	27	12		63
HSIL			2		12	16	109	2	141
Cancer							3	23	26
Total	44	673	119	16	170	66	144	28	1260

Reference Diagnosis by Adjudication Review

After all slides in the study were reviewed, all ThinPrep 2000 and ThinPrep 5000 slides were subject to an adjudication review. Adjudication was done at a facility that was not one of the study sites conducting the study. Slides for adjudication were evenly divided between three (3) adjudication panels each consisting of one (1) cytotechnologist and three (3) independent pathologists. Each adjudication panel was blinded to the original review diagnosis for all slides and each independent pathologist within each panel was also blinded to other adjudicator’s diagnoses for all slides. Adjudication consensus agreement was obtained for each slide reviewed. Consensus agreement was achieved when at least two (2) of the three (3) pathologists from a panel rendered an identical diagnosis. In cases where consensus agreement was not achieved the panel members were brought together at a multi-head microscope to review the slides together and come to a consensus diagnosis. For each specimen, an adjudicated diagnosis for the ThinPrep 2000 slide and an adjudicated diagnosis for the ThinPrep 5000 slide were obtained.

Table 19: Adjudicated ThinPrep 5000 Diagnosis vs. Adjudicated ThinPrep 2000 Diagnosis (Combined Sites)

Adjudicated ThinPrep 5000 Diagnosis	Adjudicated ThinPrep 2000 Diagnosis								
	UNSAT	NILM	ASC-US	AGUS	LSIL	ASC-H	HSIL	Cancer	Total
UNSAT	14	8				1			23
NILM	12	696	39	8	9	2	4		770
ASC-US		33	48	4	26	7	4		122
AGUS		4	1	6			4	3	18
LSIL		12	20		135	3	10		180
ASC-H		7	4	2	6	7	11		37
HSIL			7	1	9	8	66	1	92
Cancer							2	16	18
Total	26	760	119	21	185	28	101	20	1260

For each specimen, the Reference Diagnosis (RD) was considered as the most abnormal diagnosis from the adjudicated diagnoses of the ThinPrep 2000 and ThinPrep 5000 slides. In the study, there were 22 Cancer, 124 HSIL, 39 ASC-H, 202 LSIL, 23 AGUS, 120 ASC-US, and 696 NILM specimens. Thirty-four (34) specimens had UNSAT either with ThinPrep 2000 or with ThinPrep 5000 or with both. Clinical sensitivity and specificity (e.g., with reference to a histological diagnosis) cannot be measured in this study which relied on cytological examination alone. Instead, laboratory positive and negative diagnoses by both methods, ThinPrep 5000 and

ThinPrep 2000, for the specimens with Reference Diagnosis of ASC-US+ (combined ASC-US, AGUS, LSIL, ASC-H, HSIL, and Cancer), LSIL+ (combined LSIL, ASC-H, HSIL, and Cancer), ASC-H+ (combined ASC-H, HSIL, and Cancer) and HSIL+ (combined HSIL and Cancer) were compared.

Clinical Study Results

Tables 20 through 23 present the comparison of Laboratory true positive and negative rates for ASC-US+, LSIL+, ASC-H+, and HSIL+.

Table 20: Laboratory ThinPrep 5000 Results vs Laboratory ThinPrep 2000 Results for the Specimens with Reference Diagnosis of ASC-US+

In the study, there were 530 specimens with Reference Diagnosis of ASC-US+ (combined ASC-US, AGUS, LSIL, ASC-H, HSIL, and Cancer) and 696 specimens with Reference Diagnosis of NILM.

In this table, “Positive” means ASC-US+ or UNSAT, and “Negative” means NILM. All percentages are rounded to the nearest 0.1%.

ASC-US+	Positive Percent Agreement			Negative Percent Agreement		
	ThinPrep 5000 (95% CI)	ThinPrep 2000 (95% CI)	Difference (95% CI)	ThinPrep 5000 (95% CI)	ThinPrep 2000 (95% CI)	Difference (95% CI)
#1	90.9% (482/530) (88.2% to 93.1%)	89.4% (474/530) (86.5% to 91.8%)	1.5% (8/530) (-0.7% to 3.8%)	89.1% (620/696) (86.5% to 91.2%)	87.9% (612/696) (85.3% to 90.1%)	1.1% (8/696) (-1.1% to 3.5%)
#2	87.0% (461/530) (83.8% to 89.6%)	86.6% (459/530) (83.4% to 89.2%)	0.4% (2/530) (-2.7% to 3.4%)	88.6% (617/696) (86.1% to 90.8%)	90.7% (631/696) (88.3% to 92.6%)	-2.0% (-14/696) (-4.4% to 0.3%)
#3	87.5% (464/530) (84.5% to 90.1%)	88.5% (469/530) (85.5% to 90.9%)	-0.9% (-5/530) (-3.7% to 1.8%)	87.6% (610/696) (85.0% to 89.9%)	88.1% (613/696) (85.5% to 90.3%)	-0.4% (-3/696) (-2.9% to 2.0%)

Table 21: Laboratory ThinPrep 5000 Results vs Laboratory ThinPrep 2000 Results for the Specimens with Reference Diagnosis of LSIL+

In the study, there were 387 specimens with Reference Diagnosis of LSIL+ (combined LSIL, ASC-H, HSIL, and Cancer) and 839 specimens with Reference Diagnosis of (combined NILM, ASC-US, and AGUS).

In this table, “Positive” means LSIL+ or UNSAT, and “Negative” means NILM or ASC-US/AGUS. All percentages are rounded to the nearest 0.1%.

LSIL+	Positive Percent Agreement			Negative Percent Agreement		
	ThinPrep 5000 (95% CI)	ThinPrep 2000 (95% CI)	Difference (95% CI)	ThinPrep 5000 (95% CI)	ThinPrep 2000 (95% CI)	Difference (95% CI)
#1	84.8% (328/387) (80.8% to 88.0%)	86.8% (336/387) (83.1% to 89.8%)	-2.1% (-8/387) (-5.9% to 1.7%)	90.3% (758/839) (88.2% to 92.2%)	89.5% (751/839) (87.3% to 91.4%)	0.8% (7/839) (-1.1% to 2.8%)
#2	84.0% (325/387) (80.0% to 87.3%)	83.5% (323/387) (79.4% to 86.8%)	0.5% (2/387) (-3.6% to 4.6%)	91.7% (769/839) (89.6% to 93.3%)	91.4% (767/839) (89.3% to 93.1%)	0.2% (2/839) (-1.7% to 2.2%)
#3	84.0% (325/387) (80.0% to 87.3%)	87.3% (338/387) (83.7% to 90.3%)	-3.4% (-13/387) (-7.4% to 0.6%)	88.6% (743/839) (86.2% to 90.5%)	89.4% (750/839) (87.1% to 91.3%)	-0.8% (-7/839) (-2.9% to 1.2%)

Table 22: Laboratory ThinPrep 5000 Results vs Laboratory ThinPrep 2000 Results for the Specimens with Reference Diagnosis of ASC-H+

In the study, there were 185 specimens with Reference Diagnosis of ASC-H+ (combined ASC-H, HSIL, and Cancer) and 1,041 specimens with Reference Diagnosis of (combined NILM, ASC-US/AGUS, and LSIL).

In this table, “Positive” means ASC-H+ or UNSAT, and “Negative” means NILM, ASC-US/AGUS, or LSIL. All percentages are rounded to the nearest 0.1%.

ASC-H+	Positive Percent Agreement			Negative Percent Agreement		
	ThinPrep 5000 (95% CI)	ThinPrep 2000 (95% CI)	Difference (95% CI)	ThinPrep 5000 (95% CI)	ThinPrep 2000 (95% CI)	Difference (95% CI)
#1	81.6% (151/185) (75.4% to 86.5%)	84.3% (156/185) (78.4% to 88.9%)	-2.7% (-5/185) (-8.6% to 3.2%)	90.6% (943/1041) (88.7% to 92.2%)	90.6% (943/1041) (88.7% to 92.2%)	0.0% (0/1041) (-1.6% to 1.6%)
#2	81.6% (151/185) (75.4% to 86.5%)	81.1% (150/185) (74.8% to 86.1%)	0.5% (1/185) (-6.0% to 7.1%)	91.7% (955/1041) (89.9% to 93.3%)	91.1% (948/1041) (89.2% to 92.7%)	0.7% (7/1041) (-1.0% to 2.3%)
#3	85.4% (158/185) (79.6% to 89.8%)	84.9% (157/185) (79.0% to 89.3%)	0.5% (1/185) (-5.4% to 6.5%)	89.8% (935/1041) (87.8% to 91.5%)	90.6% (943/1041) (88.7% to 92.2%)	-0.8% (-8/1041) (-2.5% to 0.9%)

Table 23: Laboratory ThinPrep 5000 Results vs Laboratory ThinPrep 2000 Results for the Specimens with Reference Diagnosis of HSIL+

In the study, there were 146 specimens with Reference Diagnosis of HSIL+ (combined HSIL and Cancer) and 1,080 specimens with Reference Diagnosis of (combined NILM, ASC-US/AGUS, LSIL, and ASC-H).

In this table, “Positive” means HSIL+ or UNSAT, and “Negative” means NILM, ASC-US/AGUS, LSIL, or ASC-H. All percentages are rounded to the nearest 0.1%.

HSIL+	Positive Percent Agreement			Negative Percent Agreement		
	ThinPrep 5000 (95% CI)	ThinPrep 2000 (95% CI)	Difference (95% CI)	ThinPrep 5000 (95% CI)	ThinPrep 2000 (95% CI)	Difference (95% CI)
#1	77.4% (113/146) (70.0% to 83.4%)	80.1% (117/146) (72.9% to 85.8%)	-2.7% (-4/146) (-9.8% to 4.3%)	93.2% (1007/1080) (91.6% to 94.6%)	93.2% (1007/1080) (91.6% to 94.6%)	0.0% (0/1080) (-1.4% to 1.4%)
#2	69.9% (102/146) (62.0% to 76.7%)	74.7% (109/146) (67.0% to 81.0%)	-4.8% (-7/146) (-11.8% to 2.3%)	94.3% (1018/1080) (92.7% to 95.5%)	94.7% (1023/1080) (93.2% to 95.9%)	-0.5% (-5/1080) (-1.9% to 1.0%)
#3	78.1% (114/146) (70.7% to 84.0%)	82.9% (121/146) (75.9% to 88.1%)	-4.8% (-7/146) (-12.6% to 3.1%)	91.9% (992/1080) (90.1% to 93.3%)	92.3% (997/1080) (90.6% to 93.8%)	-0.5% (-5/1080) (-2.1% to 1.2%)

In the study, there were 2.06% (26/1260) ThinPrep 2000 slides with UNSAT results by Adjudication and 1.83% (23/1260) ThinPrep 5000 slides with UNSAT results by Adjudication.

Agreement among Laboratory Cytotechnologists/Pathologists

The following tables indicate the extent to which the laboratory cytotechnologists / pathologists at a given site agreed amongst themselves on the diagnosis, comparing the ThinPrep 5000 processor to the ThinPrep 2000 system. Tables are provided for ASC-US+ and ASC-H+.

In Table 24 for ASC-H+, the number of specimens is shown for which various levels of agreement among the CTs occurred. Either all three CTs rated the slide as positive (ASC-H+), two out of three rated it positive, one out of three, or none of them.

Table 24: Laboratory Cytotechnologist/Pathologist Agreement, All Results, ASC-H+

ASC-H+		ThinPrep 2000 System Three lab CTs have read the same ThinPrep 2000 slide from a vial				Totals
		Three CTs had ASC-H+	Two CTs had ASC-H+ & one had <ASC-H	One CT had ASC-H+ & two had <ASC-H	Three CTs had <ASC-H	
ThinPrep 5000 Processor Three lab CTs have read the same ThinPrep 5000 slide from a vial	Three CTs had ASC-H+	111	21	6	0	138
	Two CTs had ASC-H+ and one had <ASC-H	32	30	21	7	90
	One CT had ASC-H+ and two had <ASC-H	7	9	43	28	87
	Three CTs had <ASC-H	2	8	37	898	945
Totals		152	68	107	933	1260

ASC-H+		ThinPrep 2000 System Three lab CTs have read the same ThinPrep 2000 slide from a vial		Totals
		Three or two CTs had ASC-H+	Three or two CTs had <ASC-H	
ThinPrep 5000 Processor Three lab CTs have read the same ThinPrep 5000 slide from a vial	Three or two CTs had ASC-H+	194	34	242
	Three or two CTs had <ASC-H	26	1006	1032
Totals		220	1040	1260

The rate of agreement between the ThinPrep 5000 result and the ThinPrep 2000 result from the previous table is presented below. PPA is the positive percent agreement, percent of specimens of ASC-H+ diagnosis with ThinPrep 5000 slides by a majority of laboratory CT/Pathologists among all specimens of ASC-H+ diagnosis with ThinPrep 2000 slides by a majority of laboratory CT/Pathologists. NPA is the negative percent agreement, percent of specimens of <ASC-H diagnosis with ThinPrep 5000 slides by a majority of laboratory CT/Pathologists among all specimens of <ASC-H diagnosis with ThinPrep 2000 slides by a majority of laboratory CT/Pathologists.

Table 25: Rate of CT/Pathologist Agreement, ASC-H+

ASC-H+				
PPA	88.2%	(194/220)	(83.3% to 91.8%)	
NPA	96.7%	(1006/1040)	(95.5% to 97.7%)	

In Table 26 for ASCUS+, the number of specimens is shown for which various levels of agreement among the CTs occurred. Either all three CTs rated the slide as positive (ASCUS+), two out of three rated it positive, one out of three, or none of them.

Table 26: CT Agreement, All Results, ASCUS+

ASCUS+		ThinPrep 2000 System Three lab CTs have read the same ThinPrep 2000 slide from a vial				Totals
		Three CTs had ASCUS+	Two CTs had ASCUS+ & one had <ASCUS	One CT had ASCUS+ & two had <ASCUS	Three CTs had <ASCUS	
ThinPrep 5000 Processor Three lab CTs have read the same ThinPrep 5000 slide from a vial	Three CTs had ASCUS+	393	36	8	4	441
	Two CTs had ASCUS+ and one had <ASCUS	31	24	13	10	78
	One CT had ASCUS+ and two had <ASCUS	11	8	34	53	106
	Three CTs had <ASCUS	3	13	56	563	635
Totals		438	81	111	630	1260

		ThinPrep 2000 System Three lab CTs have read the same ThinPrep 2000 slide from a vial		Totals
		Three or two CTs had ASCUS+	Three or two CTs had <ASCUS	
ThinPrep 5000 Processor Three lab CTs have read the same ThinPrep 5000 slide from a vial	Three or two CTs had ASCUS+	484	35	519
	Three or two CTs had <ASCUS	35	706	741
Totals		519	741	1260

The rate of agreement between the ThinPrep 5000 result and the ThinPrep 2000 result from the previous table is presented below. PPA is the positive percent agreement, percent of specimens of ASC-US+ diagnosis with ThinPrep 5000 slides by a majority of laboratory CT/Pathologists among all specimens of ASC-US+ diagnosis with ThinPrep 2000 slides by a majority of laboratory CT/Pathologists. NPA is the negative percent agreement, percent of specimens of <ASC-US diagnosis with ThinPrep 5000 slides by a majority of laboratory CT/Pathologists among all specimens of <ASC-US diagnosis with ThinPrep 2000 slides by a majority of laboratory CT/Pathologists.

Table 27: Rate of CT Agreement, ASCUS+

ASCUS+			
PPA	93.3%	(484/519)	(90.8% to 95.1%)
NPA	95.3%	(706/741)	(93.5% to 96.6%)

Precision Studies

Within- and between-instrument precision of the ThinPrep 5000 processor were evaluated in laboratory studies using a split-sample technique.

Within-Instrument Precision

The study was designed to examine the ability of the ThinPrep 5000 system to prepare reproducible slides from the same patient specimen using the same instrument. A total of 80 specimens were enrolled in the study. Each specimen was split into three portions and processed on three separate runs of one instrument. The slides were stained, coverslipped, and then reviewed by cytotechnologists. The resulting diagnoses and specimen adequacy determinates are presented below. Seventy eight (78) specimens had all three satisfactory ThinPrep 5000 slides and 2 specimens had all slides with UNSAT results. For comparison, the same procedure was carried out using a ThinPrep 2000 system, with results also presented below.

Table 28: Within-Instrument Precision

	ThinPrep 5000	ThinPrep 2000*
Percent of specimens that have three matching NILM replicates or three matching ASC-US+ replicates	97.4% (76/78) (91.1% to 99.3%)	97.2% (69/71) (90.3% to 99.2%)
Percent of specimens that have three matching <LSIL replicates or three matching LSIL+ replicates	98.7% (77/78) (93.1% to 99.8%)	97.2% (69/71) (90.3% to 99.2%)
Percent of specimens that have three matching <HSIL replicates or three matching HSIL+ replicates	98.7% (77/78) (93.1% to 99.8%)	100% (71/71) (94.9% to 100%)
Percent of specimens that have three matching Satisfactory replicates or three matching UNSAT replicates	100% (80/80) (95.4% to 100%)	100% (71/71) (94.9% to 100%)

* 80 specimens were enrolled, but 9 were excluded due to slide breakage and other errors.

Between-Instrument Precision

The study was designed to examine the ability of the ThinPrep 5000 system to prepare reproducible slides from the same patient specimen using multiple instruments. A total of 120 specimens were enrolled in the study. Each specimen was split into three portions and processed on three instruments. The slides were stained, coverslipped, and then reviewed by cytotechnologists. The resulting diagnoses and specimen adequacy determinates are presented below. One hundred seventeen (117) specimens had all three satisfactory ThinPrep 5000 slides, one specimen had two slides with UNSAT result and one slide with Satisfactory result, one specimen had two slides with Satisfactory result and one slide with UNSAT result, and one specimen was excluded from analysis due to a broken slide. For comparison, the same procedure was carried out using a ThinPrep 2000 system, with results also presented below.

Table 29: Between-Instrument Precision

	ThinPrep 5000	ThinPrep 2000*
Percent of specimens that have three matching NILM replicates or three matching ASC-US+ replicates	94.0% (110/117) (88.2% to 97.1%)	91.1% (102/112) (84.3% to 95.1%)
Percent of specimens that have three matching <LSIL replicates or three matching LSIL+ replicates	97.4% (114/117) (92.7% to 99.1%)	94.6% (106/112) (88.8% to 97.5%)
Percent of specimens that have three matching <HSIL replicates or three matching HSIL+ replicates	98.3% (115/117) (94.0% to 99.5%)	100% (112/112) (96.7% to 100%)
Percent of specimens that have three matching Satisfactory replicates or three matching UNSAT replicates	98.3% (117/119) (94.1% to 99.5%)	98.3% (113/115) (93.9% to 99.5%)

* 120 specimens were enrolled, but 5 were excluded due to slide breakage and other errors.

Cell Count Study

The quantity of cellular material transferred onto slides, comparing ThinPrep 5000 to the ThinPrep 2000, was evaluated in a laboratory study using a split-sample technique.

Two hundred ten (210) specimens were enrolled in the study (139 NILM, 28 ASC-US, 28 LSIL, and 15 HSIL). Each specimen was split into two parts, processed on a ThinPrep 2000 and ThinPrep 5000 system, then stained and coverslipped. All slides were run on a ThinPrep Imaging System to obtain Imager object count data, which has been demonstrated to correlate closely with cytotechnologist cell count estimates. Cellularity varies among clinical specimens, so a range of cell counts was obtained.

The chart below provides a scatter plot of the count data from the matched pairs of slides in this study. The *Control* axis is the ThinPrep 2000 slide's count value, and the *Test* axis is the matching ThinPrep 5000 slide's count.

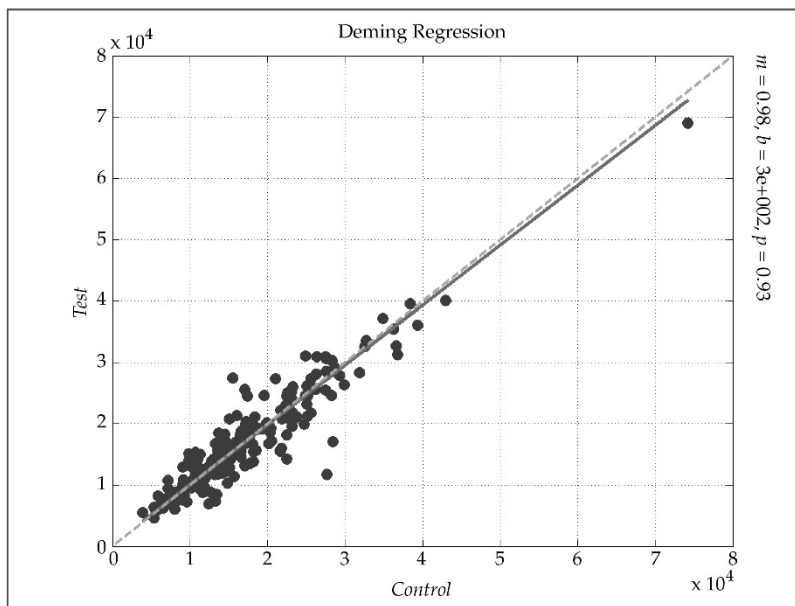

Deming regression analysis was performed and the slope was 0.98 with 95% CI: 0.94 to 1.01 and the intercept was 300 with 95% CI: -300 to 897. The data demonstrate similar cell count values on the ThinPrep 2000 and ThinPrep 5000 slides.

Cellular Carry-Over Study

Cellular carry-over between slides was evaluated in a laboratory study, with comparison of the ThinPrep 5000 and ThinPrep 2000.

On each system, 200 abnormal clinical specimens were processed, alternating with 200 blank PreservCyt vials containing no cells. After processing, slides made from the blank vials were segregated from cellular slides, stained and coverslipped, then reviewed by cytotechnologists. Any cells found on a slide were noted. Slides made from a blank vial but containing at least one cell were considered to have cellular carry-over.

The carry-over study results are presented in Table 30 below.

Table 30: Cellular Carry-Over

	ThinPrep 5000	ThinPrep 2000
Total # of Slides	200	200
# Slides with carry -over	4	38
% Slides with carry-over	2.0%	19.0%
Number of cells on the slides with carry-over: Median (Min, Max)	1 (1,5)	2 (1,28)

CONCLUSIONS

The ThinPrep® 2000 system is as effective as the conventional Pap smear in a variety of patient populations and may be used as a replacement for the conventional Pap smear method for the detection of atypical cells, cervical cancer, or its precursor lesions, as well as all other cytologic categories as defined by The Bethesda System.

The ThinPrep 2000 system is significantly more effective than the conventional Pap smear for the detection of Low-grade Squamous Intraepithelial (LSIL) and more severe lesions in a variety of patient populations.

Specimen quality with the ThinPrep 2000 system is significantly improved over that of conventional Pap smear preparation in a variety of patient populations.

Considering the technological similarity to the ThinPrep 2000 system and the comparative clinical and analytical study results, it is concluded that the ThinPrep 5000 processor is similar to the ThinPrep 2000 processor and may be used as a replacement for the conventional Pap smear method for the detection of atypical cells, cervical cancer, or its precursor lesions, as well as all other cytologic categories as defined by The Bethesda System.

MATERIALS REQUIRED

Materials Provided

ThinPrep 5000 Processor

- ThinPrep 5000 processor instrument
- ThinPrep 5000 Processor Operator's Manual
- Fixative baths with evaporation covers (3)
- Carousel (1)
- Waste bottle assembly - includes bottle, bottle cap, tubing set, fittings, waste filter
- Power cord
- Staining Racks (pkg of 10)
- Carousel cover (1)
- Absorbent pads for filter plug (4)
- Absorbent pads for evaporative cover (4)

Materials Required But Not Provided

- Slide staining system and reagents
- Standard laboratory fixative
- Coverslips and mounting media
- ThinPrep microscope slides
- 20 mL PreservCyt® Solution vial
- ThinPrep® Pap Test Filter for Gynecologic Applications
- Cervical collection device

STORAGE

- Store PreservCyt Solution between 15°C (59°F) and 30°C (86°F). Do not use beyond the expiration date printed on the container.
- Store PreservCyt Solution with cytologic sample intended for ThinPrep Pap testing between 15°C (59°F) and 30°C (86°F) for up to 6 weeks.
- Store PreservCyt Solution with cytologic sample intended for CT/NG testing using the Roche Diagnostics COBAS AMPLICOR CT/NG test between 4°C (39°F) and 25°C (77°F) for up to 6 weeks.

BIBLIOGRAPHY

1. Solomon D., Davey D, Kurman R, Moriarty A, O'Connor D, Prey M, Raab S, Sherman M, Wilbur D, Wright T, Young N, for the Forum Group Members and the 2001 Bethesda Workshop. The 2001 Bethesda System Terminology for Reporting Results of Cervical Cancer. *JAMA*. 2002;287:2114-2119.
2. Jones HW. Impact of The Bethesda System, *Cancer* 77 pp. 1914-1918, 1995.
3. American Cancer Society. Cancer Facts and Figures, 1995.
4. Ashfaq R, Gibbons D, Vela C, Saboorian MH, Iliya F. ThinPrep Pap Test. Accuracy for glandular disease. *Acta Cytol* 1999; 43: 81-5
5. Bai H, Sung CJ, Steinhoff MM: ThinPrep Pap Test promotes detection of glandular lesions of the endocervix. *Diagn Cytopathol* 2000;23:19-22
6. Carpenter AB, Davey DD: ThinPrep Pap Test: Performance and biopsy follow-up un a university hospital. *Cancer Cytopathology* 1999; 87: 105-12
7. Guidos BJ, Selvaggi SM. Detection of endometrial adenocarcinoma with the ThinPrep Pap test. *Diagn Cytopathol* 2000; 23: 260-5
8. Schorge JO, Hossein Saboorian M, Hynan L, Ashfaq R. ThinPrep detection of cervical and endometrial adenocarcinoma: A retrospective cohort study. *Cancer Cytopathology* 2002; 96: 338-43
9. Wang N, Emancipator SN, Rose P, Rodriguez M, Abdul-Karim FW. Histologic follow-up of atypical endocervical cells. Liquid-based, thin-layer preparation vs. conventional Pap smear. *Acta Cytol* 2002; 46: 453-7

TECHNICAL SERVICE AND PRODUCT INFORMATION

For technical service and assistance related to use of the ThinPrep 5000 processor, contact Hologic:

Telephone: 1-800-442-9892

Fax: 1-508-229-2795

For international or toll-free blocked calls, please contact 1-508-263-2900.

Email: info@hologic.com



Hologic, Inc.
250 Campus Drive
Marlborough, MA 01752
1-800-442-9892
www.hologic.com

©2017 Hologic, Inc. All rights reserved.
AW-11239-001 Rev. 002
8-2017

Table of Contents

Table of Contents



Table of Contents

Chapter One

INTRODUCTION

SECTION A: Overview and Function of the ThinPrep® 5000 Processor with AutoLoader.....	1.1
SECTION B: Technical Specifications.....	1.10
SECTION C: Internal Quality Control.....	1.14
SECTION D: ThinPrep 5000 Hazards	1.14
SECTION E: Disposal	1.19

Chapter Two

INSTALLATION

SECTION A: General.....	2.1
SECTION B: Action Upon Delivery	2.1
SECTION C: Preparation Prior to Installation	2.1
SECTION D: Storage and Handling Post Installation.....	2.4
SECTION E: Turn on the ThinPrep 5000 Processor with AutoLoader	2.5
SECTION F: Set User Preferences.....	2.6
SECTION G: Turn Off the ThinPrep 5000 Processor with AutoLoader	2.7

Chapter Three

PRESERVCYT® AND CYTOLYT® SOLUTIONS

SECTION A: PreservCyt Solution	3.1
SECTION B: CytoLyt Solution	3.4



CONTENTS

Chapter Four

GYNECOLOGIC SAMPLE PREPARATION

SECTION A: Gynecologic Specimen Preparation.....	4.1
SECTION B: Collection Preparation.....	4.2
SECTION C: Specimen Collection	4.3
SECTION D: Special Precautions	4.5
SECTION E: Sample Processing Troubleshooting.....	4.6

Chapter Five

NON-GYNECOLOGIC SAMPLE PREPARATION

SECTION A: Introduction	5.1
SECTION B: Required Materials.....	5.2
SECTION C: Specimen Collection	5.3
SECTION D: General Steps for Sample Preparation	5.5
SECTION E: Specimen Preparation Guidelines	5.13
SECTION F: Sample Preparation Troubleshooting.....	5.22

Chapter Six

USER INTERFACE

SECTION A: Main Screen, Instrument Idle	6.3
SECTION B: Main Screen, During Processing.....	6.16
SECTION C: Switch Modes.....	6.21
SECTION D: Administrative Options	6.22
SECTION E: Reports and Logs	6.63

*Chapter Seven***OPERATING INSTRUCTIONS**

SECTION A: Introduction	7.1
SECTION B: Material Requirements	7.1
SECTION C: Labeling the Sample Vials.....	7.3
SECTION D: Load the ThinPrep 5000 AutoLoader	7.5
SECTION E: Initiate a Batch	7.15
SECTION F: Processing Slides	7.17
SECTION G: Pause a Batch in Process.....	7.18
SECTION H: Processing Complete	7.18
SECTION I: Unload the ThinPrep 5000 Processor with AutoLoader	7.20
SECTION J: Small Batch Mode	7.20
SECTION K: Optional Instructions for Ancillary Testing.....	7.35

*Chapter Eight***MAINTENANCE**

SECTION A: Daily	8.2
SECTION B: Weekly	8.2
SECTION C: Empty the Waste Bottle	8.9
SECTION D: Clean the Touch Screen	8.14
SECTION E: Clean Input Carousel and Dust Cover.....	8.15
SECTION F: Change Absorbent Pads	8.16
SECTION G: Change Fume Extractor Filters.....	8.17
SECTION H: Remove and Clean Drip Trays	8.20
SECTION I: Replacing the User Accessible Fuses.....	8.20



CONTENTS

Chapter Nine

TROUBLESHOOTING

SECTION A: General.....	9.1
SECTION B: Sample Processing Errors.....	9.1
SECTION C: Batch Processing Errors.....	9.12
SECTION D: System Errors.....	9.18

Chapter Ten

STAINING AND COVERSLIPPING

SECTION A: General.....	10.1
SECTION B: Fixation	10.1
SECTION C: Recommended Staining Guidelines	10.2
SECTION D: Coverslipping	10.4

Chapter Eleven

THINPREP® PAP TEST TRAINING PROGRAM

SECTION A: Objective.....	11.1
SECTION B: Design	11.1
SECTION C: Bibliography	11.2

Chapter Twelve

SERVICE INFORMATION	12.1
----------------------------	-------------

Chapter Thirteen

ORDERING INFORMATION	13.1
-----------------------------	-------------

INDEX

Chapter One

Introduction

SECTION A

OVERVIEW AND FUNCTION OF THE THINPREP® 5000 PROCESSOR WITH AUTOLOADER

The ThinPrep® 5000 processor with AutoLoader is used in the batch processing of liquid-based cytologic specimens to produce a thin, uniform preparation of cells that is transferred and fixed onto a glass microscope slide. The slide is delivered directly into a staining rack in an alcohol fixative bath. After processing, the slide is ready for staining, coverslipping and screening. The processor supports the preparation of:

- **Gynecologic specimens** for use with the ThinPrep Pap test, and subsequent imaging by the ThinPrep Imaging System, or samples for gynecologic cytology screening. One sample per vial may be processed in a batch.
- **Non-gynecologic specimens** collected for general cytologic screening. One sample per vial may be processed in a batch. An advanced program feature enables a batch in which 1 to 10 samples may be removed from the vial.
- **Urine specimens** used in conjunction with the ThinPrep UroCyte® Urine Collection Kit. One sample per vial may be processed in a batch.

AutoLoader mode

The ThinPrep 5000 processor with AutoLoader can process a batch of up to 160 specimens. Four trays of sample vials are loaded into the AutoLoader portion of the instrument. Each tray holds up to 40 vials. Different sample types may be processed in the same batch, although each tray of vials must contain the same sample type.

Cassettes of microscope slides and trays of ThinPrep filters are loaded. The slides and filters are specifically used for gynecologic (including imaging), non-gynecologic and urine specimens. The slides and filters are designated via the user interface to be used with the corresponding sample types in the vial trays.

During processing the instrument will laser etch the accession ID and other optional information onto each slide. Processed slides are deposited into fixative baths containing alcohol.

Processing may be interrupted in order to remove completed slides or replenish consumable items.

1

INTRODUCTION

Small batch mode

A small batch mode allows for processing of up to 20 samples in a single batch. The sample vials, filters and pre-labeled slides are loaded directly into the carousel of the processor. Each batch may contain only one type of specimen (all gynecologic or all non-gynecologic or all UroCyt^e).



Figure 1-1 A ThinPrep 5000 Processor with AutoLoader

Note: The instructions for using the ThinPrep[®] 5000 processor with AutoLoader are the same regardless of the instrument color.

Intended Use

The ThinPrep[®] 5000 processor with AutoLoader is intended as a replacement for the conventional method of Pap smear preparation for use in screening for the presence of atypical cells, cervical cancer, or its precursor lesions (Low Grade Squamous Intraepithelial Lesions, High Grade Squamous Intraepithelial Lesions), as well as all other cytologic categories as defined by The Bethesda System for Reporting Cervical/Vaginal Cytologic Diagnoses¹.

The ThinPrep[®] Pap Test

The ThinPrep Pap test is a fluid-based method for the collection and preparation of gynecologic samples.

The ThinPrep Pap test begins at the physician's office where, using a broom-type collection device or endocervical brush/plastic spatula, cervical cells are collected from the patient. Rather than smearing the patient's sample directly onto a microscope slide, the collection device is immediately immersed and rinsed in a vial of PreservCyt[®] Solution for use with the ThinPrep Pap test.

1 Nayar R, Wilbur DC. (eds). *The Bethesda System for Reporting Cervical Cytology: Definitions, Criteria, and Explanatory Notes*. 3rd ed. Cham, Switzerland: Springer: 2015

The sample vial is then capped and tightened. Patient information is recorded onto the vial of solution containing the sample and forwarded to a laboratory equipped to process the ThinPrep Pap test.

At the laboratory, matching barcoded labels are applied to the sample vial, and accompanying test request form. The sample vial is then placed in a sample vial tray and loaded into the ThinPrep 5000 processor with AutoLoader.

(Refer to Figure 1-2.) During the slide preparation process, a gentle dispersion step breaks up blood, mucus and non-diagnostic debris and thoroughly mixes the cell sample. The cells are then collected onto a ThinPrep Pap test filter as a thin layer by creating a gentle vacuum and monitoring of the flow rate through the filter. The cells are then transferred to a ThinPrep microscope slide due to the natural adhesion properties of the cells, an electrochemical charge of the glass and a slight positive air pressure behind the filter membrane. The slide is delivered to a staining rack immersed in an alcohol fixative bath.

(For ancillary testing preparation and instructions, please refer to “OPTIONAL INSTRUCTIONS FOR ANCILLARY TESTING” on page 7.35.)

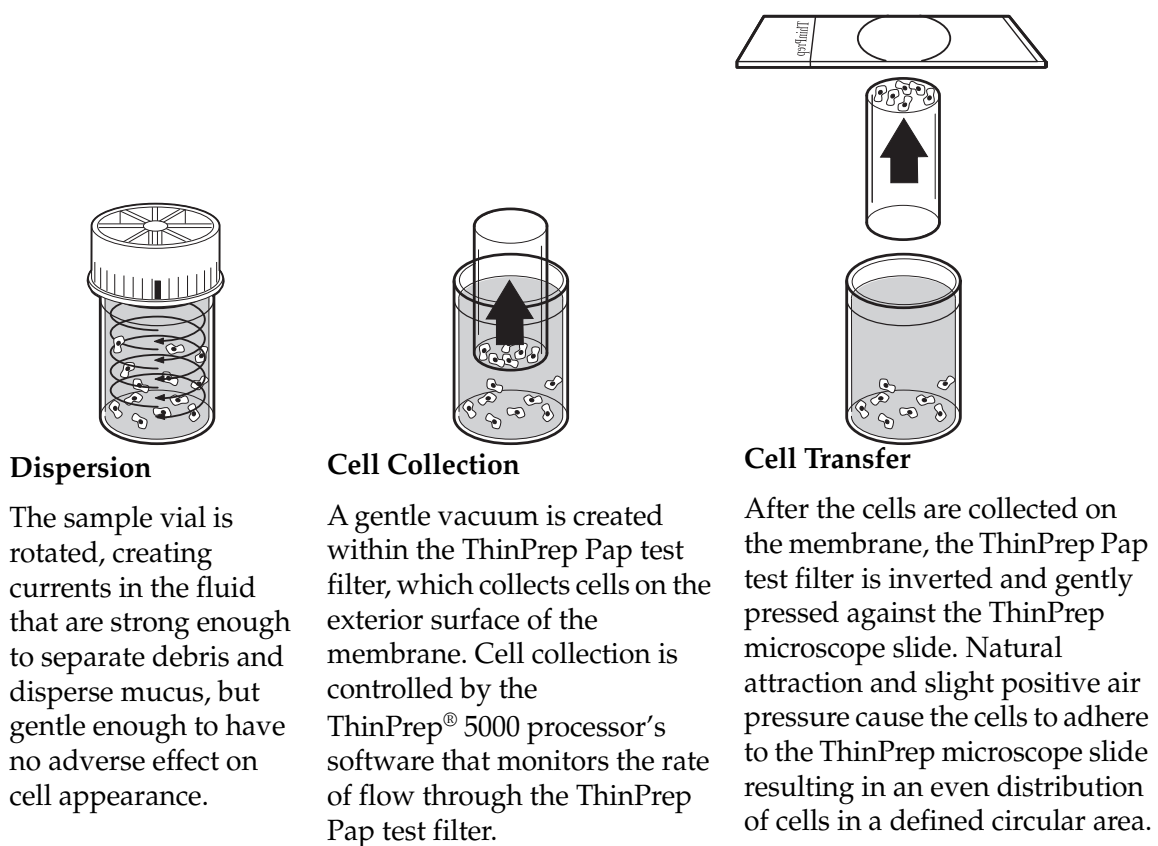

Figure 1-2 The ThinPrep Sample Preparation Process



INTRODUCTION

Limitations

- Gynecologic samples collected for preparation using the ThinPrep 5000 processor with AutoLoader should be collected using a broom-type cervical collection device or endocervical brush/plastic spatula combination collection device. Refer to the instructions provided with the collection device for warnings, contraindications, and limitations associated with specimen collection.
- Preparation of microscope slides using the ThinPrep 5000 processor with AutoLoader should be performed only by personnel who have been trained by Hologic or by organizations or individuals designated by Hologic.
- Evaluation of microscope slides produced with the ThinPrep 5000 processor with AutoLoader should be performed only by cytotechnologists and pathologists who have been trained to evaluate ThinPrep prepared slides by Hologic or by organizations or individuals designated by Hologic.
- Supplies used in the ThinPrep 5000 processor with AutoLoader are those designed and supplied by Hologic specifically for the ThinPrep 5000 processor with AutoLoader. These include PreservCyt Solution vials, ThinPrep Pap test filters, and ThinPrep microscope slides. These supplies are required for proper performance of the system and cannot be substituted. Product performance will be compromised if other supplies are used. After use, supplies should be disposed of in accordance with local, state, and federal regulations.
- A ThinPrep Pap test filter must be used only once and cannot be reused.
- The performance of HPV DNA and CT/NG testing on sample vials reprocessed with glacial acetic acid (GAA) has not been evaluated.

Contraindications

- *Chlamydia trachomatis* and *Neisseria gonorrhoeae* testing using Hologic's APTIMA COMBO 2[®] CT/NG assay and the Roche Diagnostics COBAS AMPLICOR assay should not be performed on a sample that has already been processed using the ThinPrep 5000 processor with AutoLoader.

Warnings

- For *In Vitro* diagnostic use.
- Danger. PreservCyt Solution contains methanol. Toxic if swallowed. Toxic if inhaled. Causes damage to organs. Cannot be made non-poisonous. Consult Safety Data Sheet (SDS) at www.hologicsds.com. Wear personal protective laboratory gear. Flammable liquid and vapor. Keep away from heat, sparks, open flames and hot surfaces. Evaporating alcohol could create a fire hazard. Other solutions cannot be substituted for PreservCyt Solution. PreservCyt Solution should be stored and disposed of in accordance with all applicable regulations.
- Strong oxidizers, such as bleach, are incompatible with PreservCyt Solution and therefore should not be used to clean the waste bottle.

Precautions

- This equipment generates, uses, and can radiate radio frequency energy, and if not installed and used in accordance with the operator's manual, may cause interference to radio communications. Operation of this equipment in a residential area is likely to cause harmful interference, in which case the user will be required to correct the interference at his/her own expense.
- PreservCyt Solution *with* cytologic sample intended for ThinPrep Pap testing must be stored between 15°C (59°F) and 30°C (86°F) and tested within 6 weeks of collection.
- PreservCyt Solution *with* cytologic sample intended for CT/NG testing using the Roche Diagnostics COBAS AMPLICOR CT/NG test must be stored between 4°C (39°F) and 25°C (77°F) and tested within 6 weeks of collection.
- Always use the USB drive provided with the processor. Never use a U3 Smart Drive. While the system is able to write to this device, there is a significant problem if the system is booted with one of these drives inserted in a port. Field service would be required.
- Note also that the system cannot write data to a write-protected USB key.
- PreservCyt Solution was challenged with a variety of microbial and viral organisms. The following table presents the starting concentrations of viable organisms and the log reduction of viable organisms found after 15 minutes in the PreservCyt Solution. As with all laboratory procedures, universal precautions should be followed.

Organism	Initial Concentration	Log Reduction after 15 min.
Candida albicans	5.5 x 10 ⁵ CFU/mL	>4.7
Aspergillus niger*	4.8 x 10 ⁵ CFU/mL	2.7
Escherichia coli	2.8 x 10 ⁵ CFU/mL	>4.4
Staphylococcus aureus	2.3 x 10 ⁵ CFU/mL	>4.4
Pseudomonas aeruginosa	2.5 x 10 ⁵ CFU/mL	>4.4
Mycobacterium tuberculosis**	9.4 x 10 ⁵ CFU/mL	4.9
Rabbitpox virus	6.0 x 10 ⁶ PFU/mL	5.5***
HIV-1	1.0 x 10 ^{7.5} TCID ₅₀ /mL	7.0***

* After 1 hour >4.7 log reduction

** After 1 hour >5.7 log reduction

*** Data is for 5 minutes

1

INTRODUCTION

Components

Key system components include the ThinPrep 5000 processor with AutoLoader, PreservCyt Solution sample vials in vial trays, input carousel, fixative baths, filters and microscope slides in slide cassettes.

The system is operated via a touch screen graphic user interface. The interface is available in several languages, via a user preference.

All specimen samples are collected into PreservCyt Solution vials. The sample vial is labeled with an accession number. (For samples run via Small Batch mode, the corresponding ThinPrep microscope slides must be pre-labeled with matching accession numbers.) Vial trays, slide cassettes and filter trays are loaded into the instrument. The carousel is placed into the ThinPrep 5000 processor compartment. Fixative baths containing a staining rack and fixative alcohol are placed into the output compartment. Each bath holds up to 20 processed slides.

Close the doors and select the type of sample to process and press Start.

ThinPrep[®] 5000 Processor with AutoLoader

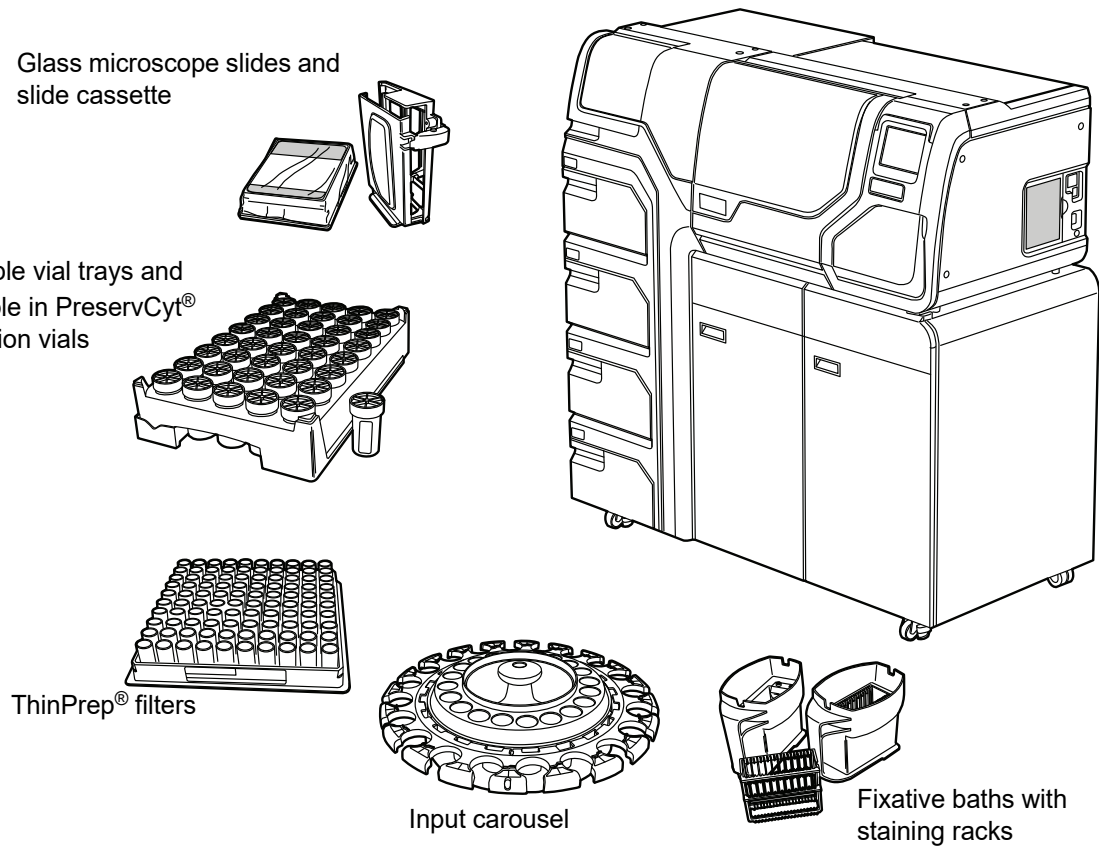

Figure 1-3 ThinPrep 5000 Processor with AutoLoader Components

Overview of Processing

For routine batch processing, the system proceeds in this fashion once the batch is started:

AutoLoader Mode		Small Batch Mode
Checks that the carousel is empty		(Operator manually loads vials, filters and slides into the carousel and loads the carousel into the processor)
Pick up the first vial, place it in the carousel and read the vial ID		
Pick a filter and put it in the carousel		Check the vial and slide IDs
Checks for slides in cassettes		
Start laser fume extractor. Pick a slide and etch it with ID from the vial ID (and any other information)		Pick up a vial and filter
Put slide in carousel and confirm the slide ID can be read and is correct		Place the vial into the disperser
Pick up slide, filter and vial and bring them to the dispersion area		Pick up the slide
Once processing begins, the system fetches subsequent vials, filters and slides	Disperse the vial contents	Disperse the vial contents
	Uncap the vial	Uncap the vial
	Place the slide on the cell transfer station (pneumatic suction holder)	Place the slide on the cell transfer station (pneumatic suction holder)
	Introduce filter to vial, wet filter and test sufficiency of fluid level	Introduce filter to vial, wet filter and test sufficiency of fluid level
	Collect cells	Collect cells
	Evacuate liquid waste	Evacuate liquid waste
	Cell transfer from filter to slide	Cell transfer from filter to slide
	Deposit slide into fixative bath	Deposit slide into fixative bath
	Puncture and dispose of filter	Puncture and dispose of filter
	Recap the vial	Recap the vial
	Return the vial to the carousel	Return the vial to the carousel
Return the vial to its original tray position		



INTRODUCTION

Materials Provided

The following items are included when the ThinPrep® 5000 processor with AutoLoader is delivered for installation.

(These items may vary according to your order.)

- ThinPrep 5000 processor with AutoLoader
- ThinPrep 5000 Processor with AutoLoader Operator's Manual
- Power cord
- System accessory kit, including:
 - Waste bottle with tubing harness and transport cover
 - Fixative baths with evaporation covers (13)
 - Carousel (1)
 - Carousel dust cover (1)
 - Absorbent pads for the filter plug (4)
 - Absorbent pads for the evaporation cover (4)
 - Staining racks (package of 10)
 - USB flash drive
 - UPS (uninterruptible power supply)
 - Sample vial trays (8)
 - Filter waste box and liner bag
 - Robotic arm area waste bin and liner
 - Slide waste box
 - Slide cassettes (6)
 - HEPA filters (5)
 - Carbon filter
- Optional items:
 - Laser network printer
 - LIS (laboratory information system) networking

Storage

- Store PreservCyt® Solution between 15°C (59°F) and 30°C (86°F). Do not use beyond the expiration date printed on the container.
- Store PreservCyt Solution *with* cytologic sample intended for ThinPrep Pap testing between 15°C (59°F) and 30°C (86°F) for up to 6 weeks.

- Store PreservCyt Solution *with* cytologic sample intended for CT/NG testing using the Roche Diagnostics COBAS AMPLICOR CT/NG test between 4°C (39°F) and 25°C (77°F) for up to 6 weeks.

The storage requirements for all types of ThinPrep filters are:

- Store filters in their trays with the cover on until ready for use.
- Store the filters in an ambient environment and out of direct sunlight.
- Check the expiration date printed on the tray label and discard if outdated.

**SECTION
B**

TECHNICAL SPECIFICATIONS

Overview of Components

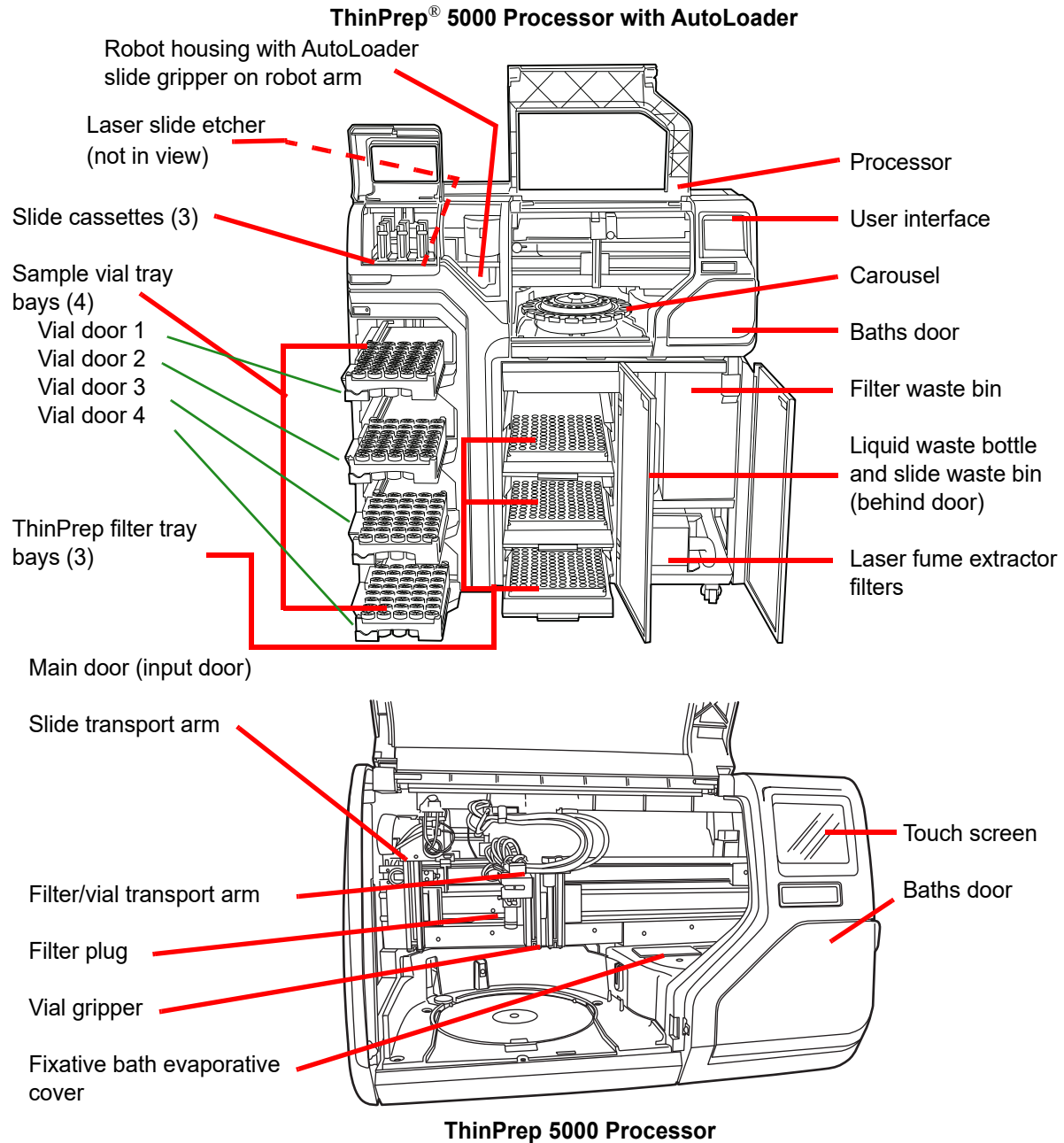

Figure 1-4 Overview of Components

Dimensions, Clearances and Weight

Dimensions: ThinPrep® 5000 processor with AutoLoader: 57 inches (145 cm) high x 54 inches (137 cm) wide x 28 inches (71 cm) deep

Weight (approximate): 660 lbs/300 kg

Waste bottle: 17 inches (43 cm) high x 6 inches (15 cm) diameter

Dimensions

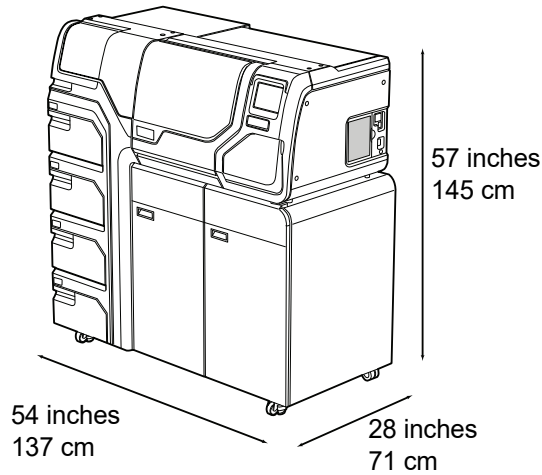

Clearances

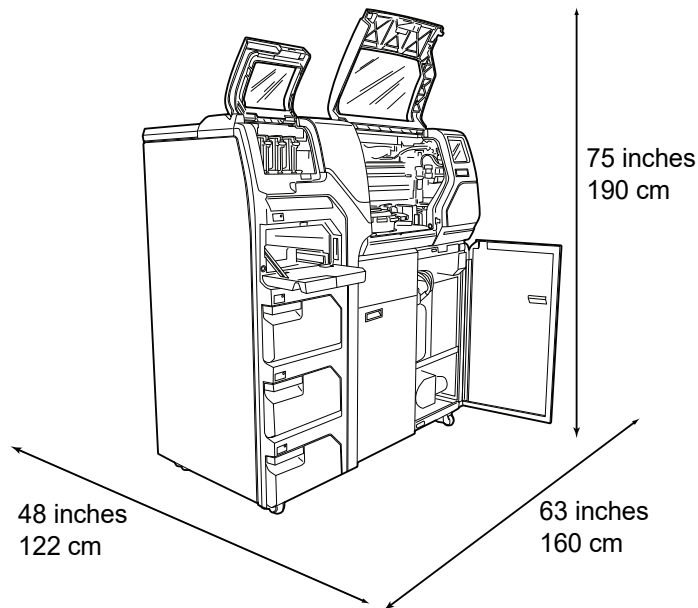

Figure 1-5 ThinPrep 5000 Processor with AutoLoader Dimensions and Clearances



INTRODUCTION

Environmental

Operating temperature

16–32°C

60–90°F

Operating humidity

20%–80% RH, non-condensing

Non-operating temperature

-28°C–50°C

-20°F–122°F

Non-operating humidity

15%–95% RH, non-condensing

Sound levels

Below 85 dBA maximum at normal operator's position

Heat load

Maximum 529 watts = 1805 BTU/hr or 1904 kJ/hr

Power

Electrical voltage & frequency power

100–120 V, ~6A, 50/60 Hz

220–240V, ~2A, 50/60 Hz

Fusing

Two 6.3A/250V 5x20 mm SLO-BLO

Laser

Type: CW CO₂ infrared

Wavelength: 10,600 nm

Rated Power: 10W max

Connections to external circuits

The external connections on the ThinPrep[®] 5000 processor with AutoLoader are PELV (Protected Extra Low Voltage) as defined by IEC 61140. Outputs of other devices connected to the processor should also be PELV or SELV (Separated Extra Low Voltage). Only devices approved for safety by an appropriate agency should be connected to the ThinPrep 5000 processor with AutoLoader.

Safety, EMI and EMC Standards

The ThinPrep 5000 processor with AutoLoader has been tested and certified by a U.S. nationally recognized testing Laboratory (NRTL) to comply with current Safety, Electro-Magnetic Interference (EMI) and Electro-Magnetic Compatibility (EMC) standards. Refer to the model/rating label, located on the rear of the instrument, to see the safety certification markings (see Figure 1-7). This equipment meets the IEC 61010-2-101 particular safety requirements for IVD equipment.

This equipment meets the emission and immunity requirements of IEC 61326-2-6. This equipment has been tested and found to comply to CISPR 11 Class A emission limits.

In a domestic environment it may cause radio interference, in which case, you may need to take measures to mitigate the interference. The electromagnetic environment should be evaluated prior to operation of the equipment. Do not use this device in close proximity to sources of strong electromagnetic radiation (e.g., unshielded RF sources), as these may interfere with the proper operation.

This product is *in vitro* diagnostic (IVD) medical equipment.

If this equipment is used in a manner not specified by the manufacturer, then the protection provided by the equipment may be impaired.

Laser Product Safety

This product contains a laser device, used to etch the sample accession ID onto the glass microscope slide.

During operation, this laser equipment functions as a Class 1 laser product pursuant to the United States Code for Federal Regulation, Title 21, Sub-Chapter J, Part 1040. This Class 1 laser product conforms to CEN ELEC EN 60825-1:2007. During normal operation the laser beam and its reflections are completely enclosed and there is no laser hazard to persons in the immediate area. There is, however, a Class 4 laser inside this product and caution should be taken whenever the access door or panels are open.

CAUTION: Use of controls and adjustments or performance of procedures other than those specified herein may result in hazardous radiation exposure.

The slide laser printing system safety enclosure is interlocked and labeled to ensure safe operation. Labels should not be removed. Interlocks should not be defeated by an operator. Service and repair of this system must only be performed by trained Hologic personnel.



INTRODUCTION

SECTION C

INTERNAL QUALITY CONTROL

Power On Self-Test (POST)

When the ThinPrep® 5000 processor with AutoLoader is powered on, the system goes through a self-diagnostic test. The electrical, mechanical and software/communications subsystems are tested to confirm that each performs properly. The operator is alerted to malfunctions by a message on the touch screen interface and by audible sound (if enabled).

SECTION D

THINPREP 5000 HAZARDS

The ThinPrep 5000 processor with AutoLoader is intended to be operated in the manner specified in this manual. Be sure to review and understand the information listed below in order to avoid harm to operators and/or damage to the instrument.

If this equipment is used in a manner not specified by the manufacturer, then the protection provided by the equipment may be impaired.

Warnings, Cautions and Notes

The terms **WARNING**, **CAUTION** and **Note** have specific meanings in this manual.







A **WARNING** advises against certain actions or situations that could result in personal injury or death.

A **CAUTION** advises against actions or situations that could damage equipment, produce inaccurate data or invalidate a procedure, although personal injury is unlikely.

A **Note** provides useful information within the context of the instructions being provided.

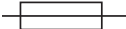
Symbols Used on the Instrument

The following symbols may appear on this instrument:

Symbol	Title	Description	Standard information
	Caution	Indicates the need for the user to consult the instructions for use for important cautionary information such as warnings and precautions that cannot, for a variety of reasons, be presented on the medical device itself.	ISO 15223-1 Medical devices—Symbols to be used with medical device labeling and information to be supplied, Section 5.4.4
	Warning; Laser beam	To warn of a laser beam	ISO 7010 Graphical symbols Safety colours and safety signs - registered safety signs, symbol W004
	Fuse	To identify fuse boxes or their location	IEC 60417 Graphical symbols for use on equipment, symbol 5016
	<i>In vitro</i> diagnostic medical device	Indicates a medical device that is intended to be used as an <i>in vitro</i> diagnostic medical device	ISO 15223-1 Medical devices—Symbols to be used with medical device labeling and information to be supplied, Section 5.5.1
	Authorized Representative in the European Community	Indicates the Authorized Representative in the European Community	ISO 15223-1 Medical devices—Symbols to be used with medical device labeling and information to be supplied, Section 5.1.2
	Manufacturer	Indicates the medical device manufacturer, as defined in the EU Directives 90/385/EEC, 93/42/EEC and 98/79/EC	ISO 15223-1 Medical devices—Symbols to be used with medical device labeling and information to be supplied, Section 5.1.1

1

INTRODUCTION







	Date of manufacture	Indicates the date when the medical device was manufactured	ISO 15223-1 Medical devices—Symbols to be used with medical device labeling and information to be supplied, Section 5.1.3
	Catalogue number	Indicates the manufacturer's catalogue number so that the medical device can be identified	ISO 15223-1 Medical devices—Symbols to be used with medical device labeling and information to be supplied, Section 5.1.6
	Serial number	Indicates the manufacturer's serial number so that a specific medical device can be identified	ISO 15223-1 Medical devices—Symbols to be used with medical device labeling and information to be supplied, Section 5.1.7
	Protective Conductor Terminal	To identify any terminal which is intended for connection to an external conductor for protection against electric shock in case of a fault, or the terminal of a protective earth (ground) electrode	IEC 60417 Graphical symbols for use on equipment, symbol 5019
	Power on	Indicates that the control places the equipment in a fully powered state.	IEC 60417-1 Graphical symbols for use on equipment, symbol 5007
	Power off	Indicates that using the control will disconnect power to the device.	IEC 60417-1 Graphical symbols for use on equipment, symbol 5008

Figure 1-6 Symbols

Location of Labels on the Instrument

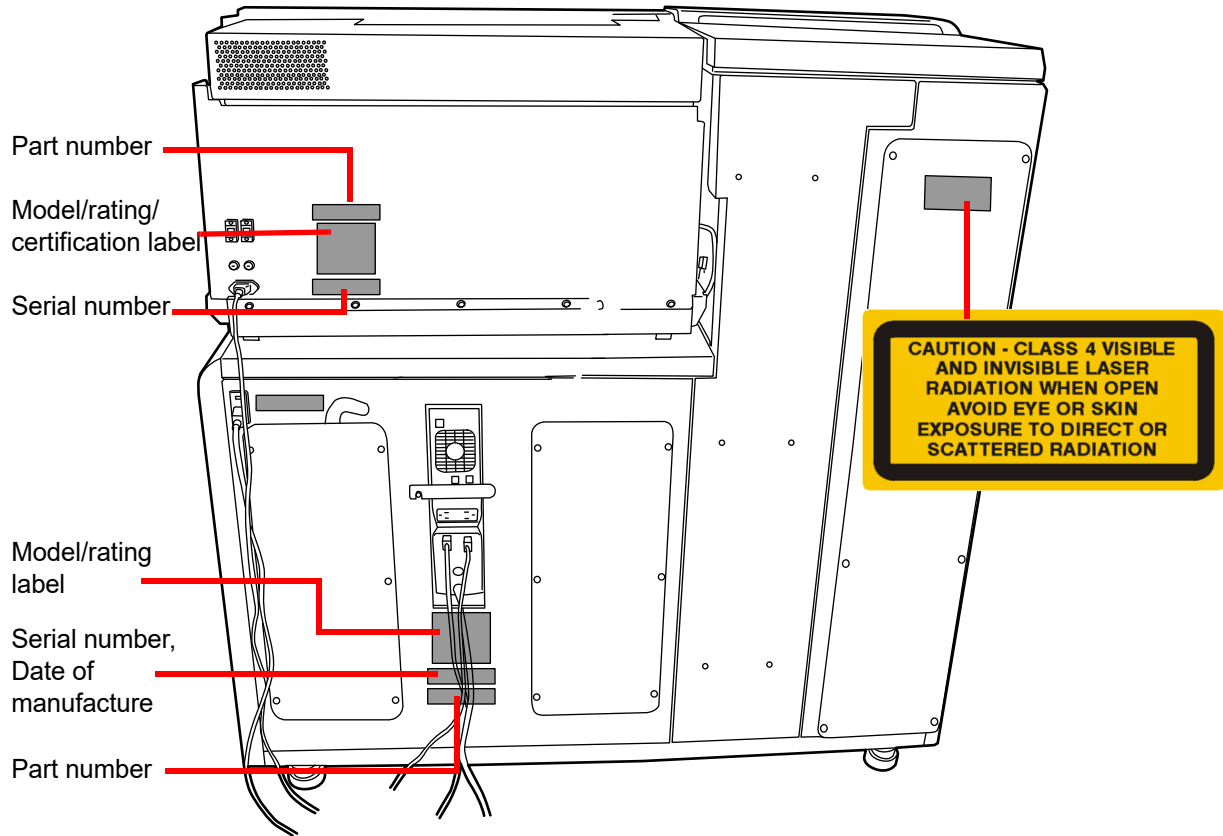

Figure 1-7 Rear of the ThinPrep® 5000 Processor with AutoLoader

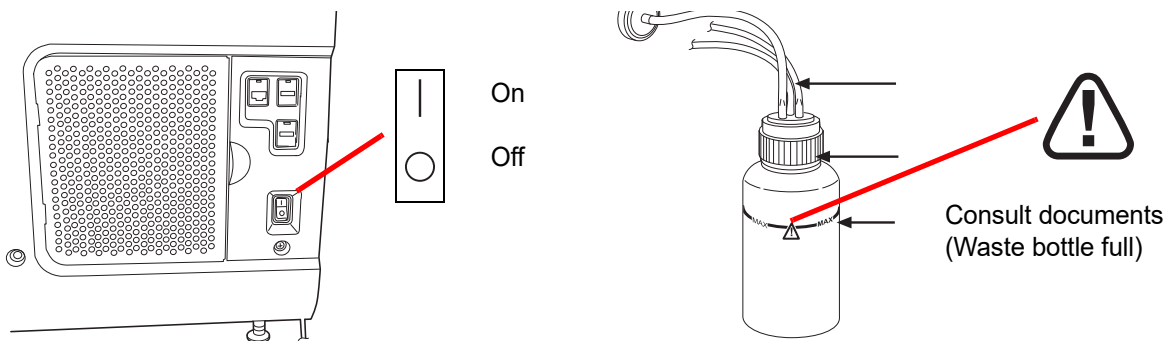

Figure 1-8 Right Side of Processor and Waste Bottle



INTRODUCTION

Warnings Used in this Manual:

WARNING

Service Installation Only

This system is to be installed by trained Hologic personnel only.

WARNING

Moving Parts

The processor contains moving parts. Keep hands, hair, loose clothing, jewelry, etc., clear. Do not operate with the doors open.

WARNING

Grounded Outlet

To ensure safe operation of the equipment, use a three-wire grounded outlet. Disconnection from the power source is by removal of the power cord.

WARNING

Toxic Mixtures

Danger. PreservCyt[®] Solution contains methanol. Toxic if swallowed. Toxic if inhaled. Causes damage to organs. Cannot be made non-poisonous. Keep away from heat, sparks, open flames and hot surfaces. Other solutions cannot be substituted for PreservCyt Solution.

Danger. CytoLyt[®] Solution contains methanol. Harmful if swallowed. Harmful if inhaled Causes damage to organs. Cannot be made non-poisonous. Keep away from heat, sparks, open flames and hot surfaces. Other solutions cannot be substituted for CytoLyt Solution.

Follow the manufacturer's recommendations for reagent handling and cleanup of spills. Refer to manufacturer's SDS for more information. Wear protective laboratory gear.

WARNING

Flammable Liquid and Vapor

Flammable liquids. Keep away from heat, sparks, open flames and hot surfaces.

WARNING

Glass

The instrument uses microscope slides, which have sharp edges. In addition, the slides may be broken in their storage packaging or on the instrument. Use caution when handling glass slides and cleaning the instrument.

WARNING**Instrument Fusing**

For continued protection against fire, replace only with fuses of the specified type and current rating. Refer to the Maintenance chapter for instructions on replacing user accessible fuses. Refer to Ordering Information for fuse specification and ordering.

WARNING**Laser Device**

This product contains a Class 4 laser product. Never operate the instrument with doors open or panels removed.

WARNING

Do not process a cerebrospinal fluid (CSF) specimen or other sample type that is suspected of possessing prion infectivity (PrPsc) derived from a person with a TSE, such as Creutzfeldt-Jakob disease, on a ThinPrep processor. A TSE-contaminated processor cannot be effectively decontaminated and therefore must be properly disposed of in order to avoid potential harm to users of the processor or service personnel.

**SECTION
E****DISPOSAL****Disposal of Consumable Items**

CAUTION: All disposables are for single use only and should not be reused.

- **PreservCyt® Solution.** Follow local, state, provincial and federal or county guidelines. Dispose of all solvents as hazardous waste.
- **CytoLyt® Solution.** Dispose of as a biohazard.
- **Fixative reagent.** Follow local, state, provincial and federal or county guidelines. Dispose of all solvents as hazardous waste.
- **Used ThinPrep filters.** Dispose of as regular waste.
- **Waste bottle contents.** Dispose of all solvents as hazardous waste. Follow local, state, provincial and federal or county guidelines. As with all laboratory procedures, universal precautions should be followed.
- **Used carbon filter** (from the fume extractor). Dispose of as regular waste.
- **Used HEPA filter** (from the fume extractor). Follow local, state, provincial and federal or county guidelines.



INTRODUCTION

- **Absorbent pads** for fixative bath evaporation cover and filter arm. Dispose of as regular waste. (If dripping wet, dispose of as hazardous waste.)
- **Broken glass.** Dispose of in a Sharps container.

Disposal of the Instrument

Do not dispose in municipal waste.

Please contact Hologic Technical Support.

Hologic will provide for the collection and proper reclamation of electrical devices we provide to our customers. Hologic strives to reuse Hologic devices, subassemblies, and components whenever possible. When reuse is not appropriate, Hologic will ensure the waste material is properly disposed of.



Hologic, Inc.
250 Campus Drive
Marlborough, MA 01752 USA
Tel: 1-800-442-9892
1-508-263-2900
Fax: 1-508-229-2795
Web: www.hologic.com

Safety Data Sheet

CytoLyt Solution; PreservCyt Solution:

The Safety Data Sheet (SDS) for these solutions may be requested from Hologic Technical Support, or found online at www.hologicsds.com.

For other reagents, refer to the manufacturer's SDS.

Chapter Two

Installation

WARNING: Service Installation Only

SECTION A

GENERAL

The ThinPrep[®] 5000 processor with AutoLoader must be installed by personnel who have completed Hologic service training for the instrument. When installation is complete, the operator(s) are trained, using the operator's manual as the training guide.

SECTION B

ACTION UPON DELIVERY

Remove and read the *Operating Instructions Prior to Installation* sheet attached to the packing carton.

Inspect the packing cartons for damage. Report any damage immediately to the shipper and/or Hologic Technical Support as soon as possible. (Refer to Chapter 12, Service Information.)

Leave the instrument in the packing cartons for Hologic service installation.

Store the instrument in a suitable environment until installation (cool, dry, vibration-free area).

SECTION C

PREPARATION PRIOR TO INSTALLATION

Pre-Installation Site Assessment

A pre-installation site assessment is performed by Hologic service personnel. Be sure to have prepared any and all site configuration requirements as instructed by the service personnel.

Location

Locate the ThinPrep 5000 processor with AutoLoader near (within 3 meters) a three-wire grounded power outlet that is free of voltage fluctuations and power surges. The processor will be connected to a UPS (uninterruptible power supply), which will be plugged into the electrical outlet. Refer to Figure 1-5 to ensure that there is sufficient clearance around the processor. If the processor will be

2

INSTALLATION

configured with an optional printer and/or router, they may be plugged into the UPS. (See Figure 2-2.) The components of the ThinPrep® 5000 processor with AutoLoader should be close enough to comfortably make all connections.

During operation the ThinPrep 5000 processor with AutoLoader is sensitive to vibrations. It should be located on a flat, sturdy surface that can support the 660 lbs/300 kg that it weighs. It should be placed away from any vibrating equipment.



Figure 2-1 A Typical ThinPrep 5000 Processor with AutoLoader

CAUTION: Route all connectors carefully to avoid pinching the cables. To avoid tripping over or disconnecting cabling, do not place cabling near foot traffic.

Network Connectivity

The ThinPrep 5000 processor with AutoLoader can be connected to an external network router (provided by Hologic). Optional connection for the router includes a Hologic-supplied Network Attached Storage (NAS), customer Laboratory Information System (LIS) or a Hologic-supplied network printer. See Figure 2-2 for an example of a network configuration.

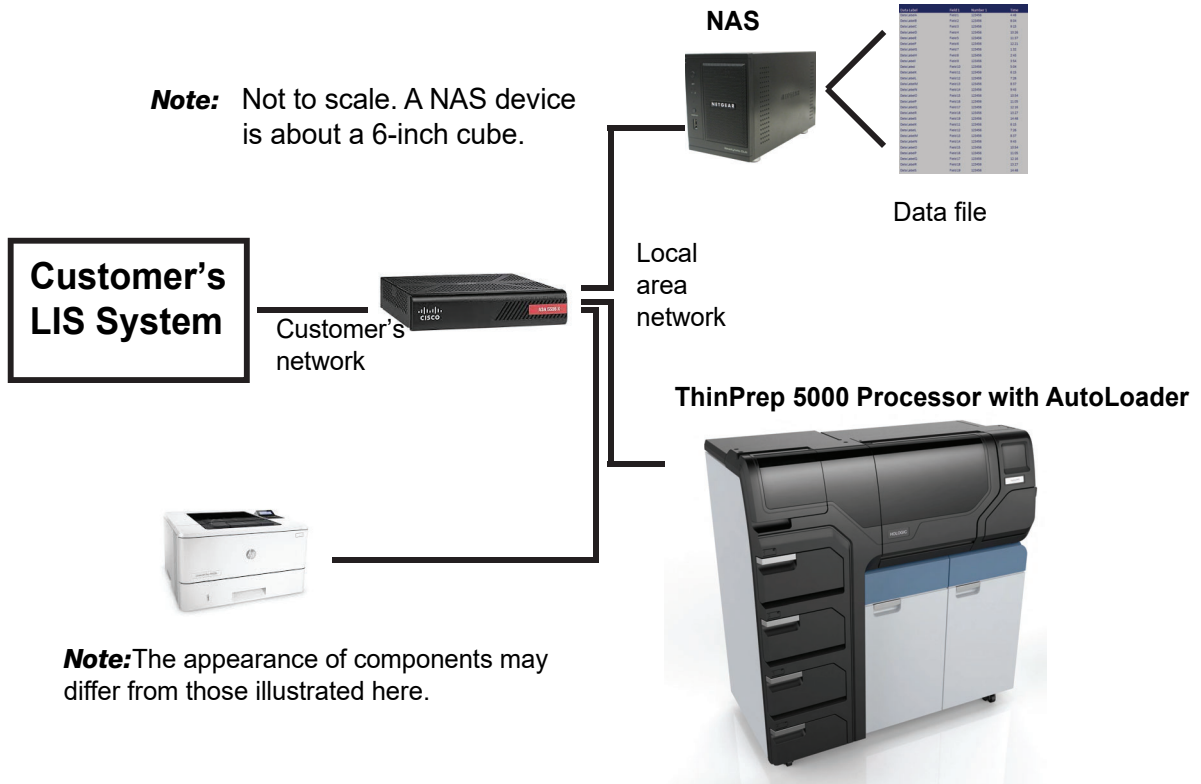

Figure 2-2 Local Network Interconnection Schematic (Example)

The NAS device is provided by Hologic as a means to store files from the ThinPrep 5000 processor with AutoLoader. This NAS device will be added to the Hologic network side of the router.

The instrument LIS interface is compatible with a variety of LIS systems. Hologic can provide guidance on configuration capabilities and constraints for setting up the LIS connection. Hologic will validate the integrity of the instrument LIS interface. The end user will be responsible for all changes to their LIS system as Hologic makes no representation or warranties with respect to the user's LIS system.

2

INSTALLATION

Connection Ports on the Instrument

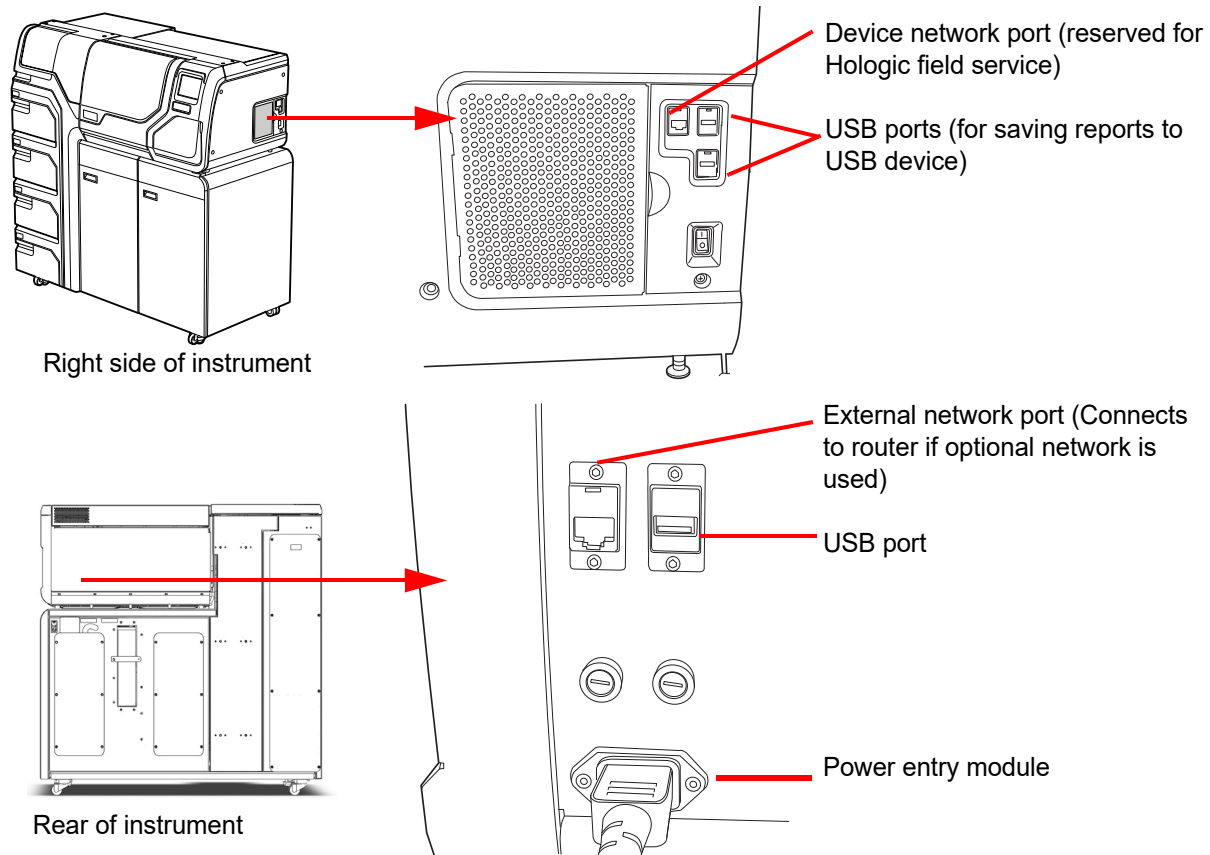

Figure 2-3 Connection Ports Locations

SECTION D

STORAGE AND HANDLING POST INSTALLATION

The ThinPrep® 5000 processor with AutoLoader may be stored where it is installed. Be sure to clean and maintain the instrument as described in the Maintenance chapter of this manual.

If the ThinPrep 5000 processor with AutoLoader is to be moved or shipped to a new location, please contact Hologic Technical Support. (Refer to Chapter 12, Service Information.)

SECTION
E

TURN ON THE THINPREP 5000 PROCESSOR WITH AUTOLOADER

CAUTION: Do not power on the processor while a USB key is in any of the USB ports. See Figure 2-3 for USB port locations.

All doors must be closed prior to turning on the processor.

Press the rocker switch located on the lower right side of the processor to the on position. See Figure 2-4.

Note: There is a power switch on the rear of the AutoLoader - always leave that on, and only power the entire system on or off via the switch on the processor portion of the instrument.

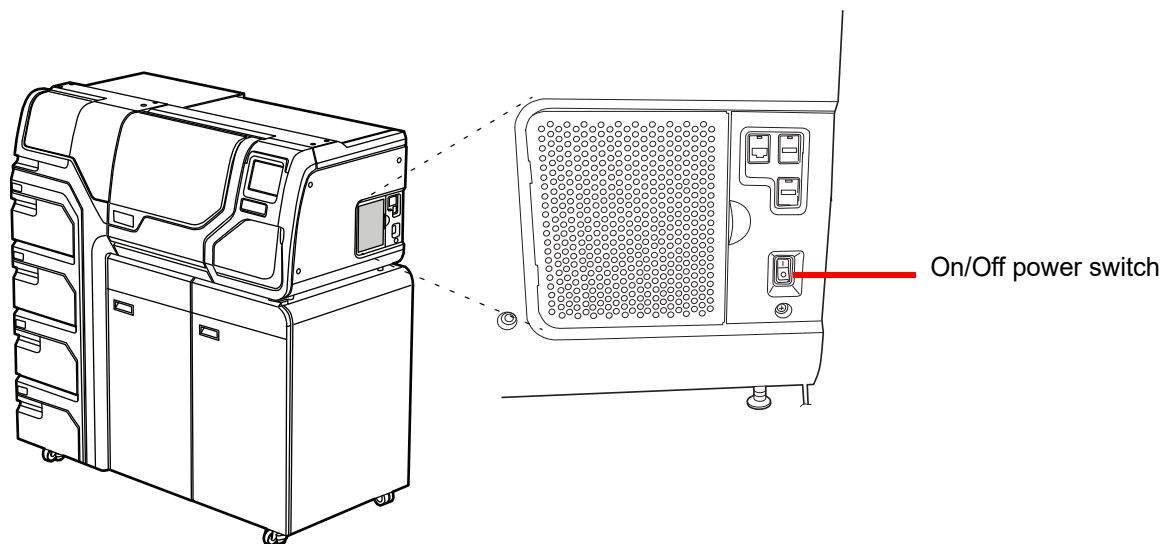

Figure 2-4 Power Switch

The user interface will display the ThinPrep® 5000 processor logo while the system boots and the main screen will appear when the processor is ready for use. The pump/compressor will be heard to energize and the mechanisms will move and then position for access. The doors will unlock.

Note: The ThinPrep 5000 processor with AutoLoader is intended to be left on. For shutdown or extended shutdown, see page 2.7.

2

INSTALLATION



Figure 2-5 Startup Screens

SECTION F

SET USER PREFERENCES

The following preferences may be set via the touch screen interface. These settings may be reset at any time and any settings will persist even if the instrument is powered off and powered on again.

- Set Time And Date - page 6.25.
- Set Lab Name - page 6.26
- Set Instrument Name - page 6.27
- Set Language - page 6.31
- Set Audible Sound - page 6.28
- Printer - page 6.33

SECTION
G

TURN OFF THE THINPREP® 5000 PROCESSOR WITH AUTOLOADER

Normal Shutdown

CAUTION: Never turn off power to the instrument without first quitting the application via the user interface.

If the instrument is to be turned off, it must be in an idle state. If a batch is in progress, either let it finish, or stop the batch. To shut down, touch the **Admin Options** button on the user interface and press the **Shutdown** button.



Figure 2-6 Shutdown Button

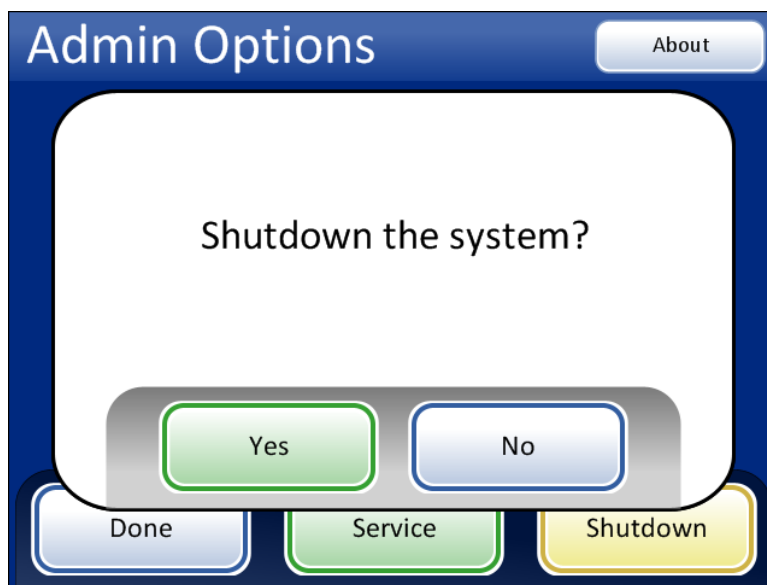

Figure 2-7 Shutdown Confirmation

A confirmation box will be displayed on the touch screen. Press the **Yes** button to proceed with system shutdown. Wait for the application to turn off (wait until the touch screen interface goes blank). Then turn off the power switch located on the right side of the instrument.

Press the **No** button to cancel shutdown and return to the Admin Options screen.



INSTALLATION

Extended Shutdown

If the instrument is to be shut down for an extended amount of time, or be taken out of service, empty the waste bottle (Maintenance chapter), remove any items that may be on board and close all doors. Follow the instructions for Normal Shutdown. Completely remove power to the instrument by unplugging the power cord from the UPS and the UPS from the outlet.

WARNING: Never disconnect the UPS wall plug when the instrument is running on battery power. The instrument needs to remain connected to ground through the UPS.

Chapter Three

PreservCyt® & CytoLyt® Solutions

SECTION A

PRESERVCYT SOLUTION

The following sections describe the function and specifications of the cytologic preservative fluid, PreservCyt® Solution.

PreservCyt Solution is a methanol-based, buffered solution designed to preserve cells during transport and slide preparation on the ThinPrep® 5000 processor with AutoLoader.

The slide preparation process on the ThinPrep 5000 processor with AutoLoader also requires PreservCyt Solution for transporting and storing samples prior to processing. PreservCyt Solution is optimized for the ThinPrep processor slide preparation process and cannot be substituted with any other reagents.

Packaging

Please refer to the Ordering Information in this manual for part numbers and detailed information regarding the ordering of solutions and supplies for the ThinPrep 5000 processor with AutoLoader.

- Vials (20 mL) of PreservCyt Solution are contained in each ThinPrep Pap test.

Composition

PreservCyt Solution is a buffered solution containing methanol. It contains no reactive ingredients. It contains no active ingredients.

WARNING: Danger. PreservCyt Solution contains methanol. Toxic if swallowed. Toxic if inhaled. Causes damage to organs. Cannot be made non-poisonous. Keep away from heat, sparks, open flames and hot surfaces. Other solutions cannot be substituted for PreservCyt Solution.

Storage Requirements

- Store PreservCyt Solution between 15°C (59°F) and 30°C (86°F). Do not use beyond the expiration date printed on the container.
- Store PreservCyt Solution *with* cytologic sample intended for ThinPrep Pap testing between 15°C (59°F) and 30°C (86°F) for up to 6 weeks.

3

PRESERVCYT® & CYTOLYT® SOLUTIONS

- Store PreservCyt Solution *with* cytologic sample intended for CT/NG testing using the Roche Diagnostics COBAS AMPLICOR CT/NG test between 4°C (39°F) and 25°C (77°F) for up to 6 weeks.

Note: Refer to “OPTIONAL INSTRUCTIONS FOR ANCILLARY TESTING” on page 7.35 for instructions for aliquot removal for ancillary testing prior to running the ThinPrep Pap test.

- Storage requirements for quantities of PreservCyt® Solution are dependent on local regulations regarding the size and configuration of your facility. Please refer to the Solutions Storage Guide at the end of this chapter.

Transportation

When transporting a PreservCyt Solution vial containing cells, make sure the vial is tightly sealed. Align the mark on the cap with the mark on the vial as shown in Figure 3-1 to prevent leakage. If the cap on the vial does not have a torque line, ensure the cap is tightened securely for storage.

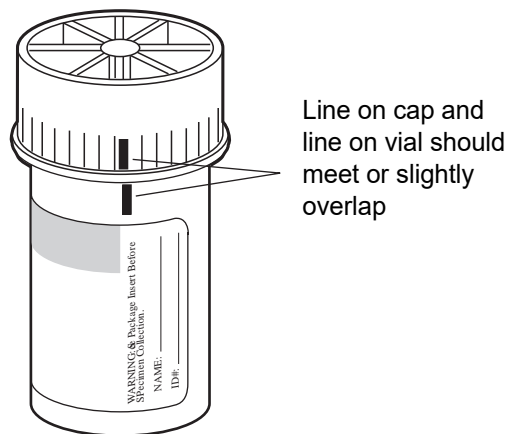

Figure 3-1 Aligning the Vial Cap

The shipping category for PreservCyt Solution is:

“flammable liquids, n.o.s. (methanol)” (USA only)

“flammable liquids, toxic, n.o.s. (methanol) (outside the USA)

The shipping category for PreservCyt Solution containing cells is “diagnostic sample.”

Please refer to the Shipping Requirements and Recommendations guide at the end of this chapter.

Stability

Do not use PreservCyt Solution after the expiration date on the container label. If making multiple slides from the same sample vial, be sure to make the slides before the expiration date marked on the sample vial. Expired vials should be discarded using appropriate laboratory procedures. Also, refer to the Storage Requirements earlier in this section for cell preservation limits.

Handling/Disposal

Handle all chemical-containing materials carefully in accordance with safe laboratory practices. When required by reagent composition, additional precautions are marked on the reagent containers or in the instructions for use.

Dispose of PreservCyt® Solution according to the guidelines for disposing of hazardous waste. PreservCyt Solution contains methanol.

PreservCyt Solution was challenged with a variety of microbial and viral organisms. The following table presents the starting concentrations of viable organisms and the log reduction of viable organisms found after 15 minutes in the PreservCyt Solution. As with all laboratory procedures, universal precautions should be followed.

Organism	Initial Concentration	Log Reduction after 15 min.
Candida albicans	5.5×10^5 CFU/mL	>4.7
Aspergillus niger*	4.8×10^5 CFU/mL	2.7
Escherichia coli	2.8×10^5 CFU/mL	>4.4
Staphylococcus aureus	2.3×10^5 CFU/mL	>4.4
Pseudomonas aeruginosa	2.5×10^5 CFU/mL	>4.4
Mycobacterium tuberculosis**	9.4×10^5 CFU/mL	4.9
Rabbitpox virus	6.0×10^6 PFU/mL	5.5***
HIV-1	$1.0 \times 10^{7.5}$ TCID ₅₀ /mL	7.0***

* After 1 hour >4.7 log reduction

** After 1 hour >5.7 log reduction

*** Data is for 5 minutes

Safety Data Sheet

The SDS for PreservCyt Solution is included in the packaging of the product. It may also be accessed at www.hologicsds.com.



SECTION
B

CYTOLYT[®] SOLUTION

CytoLyt Solution is a methanol-based, buffered, preservative solution designed to lyse red blood cells, prevent protein precipitation, dissolve mucus, and preserve morphology of general cytology samples. It is intended as a transportation medium and is used in specimen preparation prior to processing. It is not intended for complete inactivation of microbes. Chapter 5, Non-Gynecologic Sample Preparation, describes the uses of CytoLyt Solution in detail.

Packaging

Please refer to the Ordering Information in this manual for part numbers and detailed information regarding the ordering of solutions and supplies for the ThinPrep[®] 5000 processor with AutoLoader.

Composition

CytoLyt Solution contains methanol and buffer.

WARNING: Danger. CytoLyt Solution contains methanol. Harmful if swallowed. Harmful if inhaled. Causes damage to organs. Cannot be made non-poisonous. Keep away from heat, sparks, open flames and hot surfaces. Other solutions cannot be substituted for CytoLyt Solution.

Storage Requirements

- Store the containers at 15°C– 30°C without cells.
- Cells in CytoLyt Solution are preserved for 8 days at room temperature; however, for best results, transport specimen to the laboratory immediately for processing. This 8-day preservation period pertains to samples in a minimum CytoLyt Solution-to-sample ratio of one part CytoLyt Solution to three parts sample.
- Storage requirements for quantities of CytoLyt Solution are dependent on local regulations regarding the size and configuration of your facility. Please refer to the Solution Storage Guide at the end of this chapter.

Transportation

Make sure the tubes and specimen cups containing CytoLyt Solution are tightly sealed. Align the mark on the cap with the mark on the vial to prevent leakage.

Stability

Do not use CytoLyt Solution after the expiration date on the container label. Refer to the Storage Requirements earlier in this section for cell preservation limits.



Handling/Disposal

Handle all chemical-containing materials carefully in accordance with safe laboratory practices.

Safety Data Sheet

The SDS for CytoLyt Solution is included in the packaging of the product. It may also be accessed at www.hologicsds.com.



This page intentionally left blank.

The National Fire Protection Association (NFPA) is the expert authority that local fire departments and fire safety code enforcement authorities look to for fire safety standards and codes. Their codes are developed through a consensus standards development process approved by the American National Standards Institute. The NFPA codes are used as guidelines by most fire code enforcement agencies. Since these codes are guidelines, your local Authority Having Jurisdiction (AHJ) for fire code enforcement may make the final determination. The summary chart below is based upon guidelines for facilities protected by standard sprinkler systems. ⁽³⁾

The ThinPrep products NFPA ratings are listed in a table below this chart.

Use this chart to help you determine your maximum storage limits for flammable and combustible liquids.

Maximum Quantities of Flammable and Combustible Liquids in Laboratory Units Outside of Inside Liquid Storage Areas⁽⁴⁾														
Lab Unit Fire Hazard Class	Flammable & Combustible Liquid Class	NFPA Code	Quantities in Use						Quantities in Use and Storage					
			Max per 100ft ² (9.2m ²) of Lab Unit ⁽⁵⁾			Max Quantity per Lab Unit			Max per 100ft ² (9.2m ²) of Lab Unit ⁽⁵⁾			Max Quantity per Lab Unit		
			Gallons	Liters	Vials ⁽⁸⁾	Gallons	Liters	Vials ⁽⁸⁾	Gallons	Liters	Vials ⁽⁸⁾	Gallons	Liters	Vials ⁽⁸⁾
A (High)	I	45-2015	10	38	1900	480	1820	91,000	20	76	3800	480	1820	91,000
	I, II, IIIA	45-2015	20	76	3800	800	3028	151,400	40	150	7500	1600	6060	303,000
B⁽⁶⁾ (Moderate)	I	45-2015	5	19	950	300	1136	56,800	10	38	1900	480	1820	91,000
	I, II, IIIA	45-2015	10	38	1900	400	1515	75,750	20	76	3800	800	3028	151,400
C⁽⁷⁾ (Low)	I	45-2015	2	7.5	375	150	570	28,500	4	15	750	300	1136	56,800
	I, II, IIIA	45-2015	4	15	750	200	757	37,8520	8	30	1500	400	1515	75,750
D⁽⁷⁾ (Minimal)	I	45-2015	1	4	200	75	284	14,200	2	7.5	375	150	570	28,500
	I, II, IIIA	45-2015	1	4	200	75	284	14,200	2	7.5	375	150	570	28,500

Maximum Quantities of PreservCyt Solution (Class IC) That Can Be Stored per Fire Area⁽⁹⁾ Outside a Safety Flammable Cabinet					
Location		NFPA Code	Gallons	Liters	Vials ⁽⁸⁾
General Warehouse ⁽¹⁰⁾⁽¹²⁾⁽¹³⁾		30-2015	120	460	23,000
Liquid Warehouse ^(3,11)		30-2015	Unlimited	Unlimited	Unlimited
Office, to include Exam Rooms		30-2015	10	38	1900

Allowable Quantities of PreservCyt Solution That Can Be Stored in a Liquid Storage Room						
Location			NFPA Code	Gallons	Liters	Vials ⁽⁸⁾
Maximum allowable storage per ft ² in an inside storage room that is smaller than 150ft ² in size.			30-2015	5	19	950
Maximum allowable storage per ft ² in an inside storage room that is larger than 150ft ² and less than 500ft ² in size.			30-2015	10	38	1900

- (1) Solution classifications: PreservCyt – Class IC; CytoLyt – Class II; CellFyx – Class IB
- (2) This information is Hologic’s summary of the various regulations. To view the codes in their entirety, please refer to NFPA 30 and NFPA 45.
- (3) A Liquid Warehouse shall have a sprinkler system that complies with the appropriate system indicated in NFPA 30.
- (4) An Inside Liquid Storage Area is a storage room totally enclosed within a building and having no exterior walls.
- (5) A Laboratory Unit is the area surrounded by firewalls per NFPA 30 *Flammable and Combustible Liquids Code*.
- (6) Reduce quantities by 50% for B laboratory units located above the 3rd floor.
- (7) Reduce quantities by 25% for C and D laboratory units located on the 4th-6th floors of a building and reduce quantities by 50% for C and D laboratory units above the 6th floor
- (8) 20ml PreservCyt vials.
- (9) A Fire Area is the area of a building separated from the remainder of the building by construction having a fire resistance of at least 1-hour and having all communicating openings properly protected by an assembly having a fire resistance rating of at least 1-hour per NFPA 30 *Flammable and Combustible Liquids Code*.

- (10) Allowable quantities in a warehouse can be increased with a sprinkler system rated higher than standard systems.
- (11) A Liquid Warehouse is a separate, detached building or attached building used for warehousing-type operations for liquids.
- (12) Quantities are permitted to be increased 100% where stored in approved flammable liquids storage cabinets.
- (13) Quantities are permitted to be increased 100% in buildings equipped throughout with an automatic sprinkler system installed in accordance with NFPA13, Standard for the Installation of Sprinkler Systems.

This table lists the NFPA ratings for all the ThinPrep products.

ThinPrep Product	Health Hazard	Flammability Hazard	Instability Hazard	Specific Hazard
ThinPrep PreservCyt Solution	2	3	0	N/A
ThinPrep CytoLyt Solution	2	2	0	N/A
ThinPrep CellFyx Solution	2	3	0	N/A
ThinPrep Rinse Solution	0	0	0	N/A
ThinPrep Bluing Solution	0	0	0	N/A
ThinPrep Rinse II Solution	2	3	0	N/A
ThinPrep Bluing II Solution	0	0	0	N/A
ThinPrep Stain EA Solution	2	3	0	N/A
ThinPrep Stain Orange G Solution	2	3	0	N/A
ThinPrep Nuclear Stain	2	0	0	N/A

ThinPrep® Solutions Shipping Requirements *

Scope:

These requirements include shipping:

- Biological specimens (patient specimens) in ThinPrep® solutions
- Biological specimens in solutions other than ThinPrep® solutions
- Biological specimens not in solutions
- ThinPrep® PreservCyt™ Solution without biological specimens
- ThinPrep® CytoLyt™ Solution without biological specimens

Note: Shippers of Hazardous Materials or Dangerous Goods must be trained according to the various Hazardous Materials/Dangerous Good regulations

A. Shipping Requirements when shipping patient samples in ThinPrep PreservCyt Solution only – Ambient Temperature:

1. Patient samples / biological substances (pathogens) contained ThinPrep PreservCyt Solution are neutralized or inactivated by the solution and as such no longer pose a health risk. (For further information regarding this, refer to the ThinPrep 2000 or ThinPrep 5000 Operators' Manual).
2. Materials that have been neutralized or inactivated are exempt from the Category B Class 6, Division 6.2 requirements.
3. Solutions that contain neutralized or inactivated pathogens, and meet the criteria of one or more of the other hazards risks, must be shipped according to the shipping requirements for that hazard risk(s).
4. ThinPrep PreservCyt Solution is a Flammable liquid when shipped domestic or international. Therefore, follow the instructions in Section C below, Shipping ThinPrep® PreservCyt™ Solution Only (such as from a laboratory to a physician).

B Shipping Biological Specimens in Solutions (other than ThinPrep PreservCyt Solution) or Without Solutions

Notes:

When biological specimens are shipped in a solution of a quantity of 30 ml or less and are packed in accordance with these guidelines, no further requirements in the Hazardous Materials (Dangerous Goods) Regulations need be met. However, training is recommended.”¹

Definitions:

- Biological Substance, Category B: Materials containing or suspected to contain infectious substances that do not meet Category A criteria. IATA Dangerous Goods regulations were revised with an effective date of January 1, 2015. Note: The term “diagnostic specimen” has been replaced with “biological substance, Category B”
- Exempt specimens: Specimens that with the minimal likelihood that pathogens are present (fixed tissue, etc.)

* These instructions are Hologic's interpretation of the various regulations as of the effective date. However, Hologic will not be responsible for any non-conformance to the actual regulations.

Shipping Requirements Category B or Exempt ¹ – Ambient Temperature:

1. Packaging must consist of three components
 - a. a primary receptacle, leak proof
 - b. secondary packaging, leak proof
 - c. a rigid outer packaging

NOTES:

- FedEx will not accept clinical samples or diagnostic specimens packaged in FedEx envelopes, FedEx tubes, FedEx Paks, or FedEx Boxes, Styrofoam boxes, plastic bags, or paper envelopes.
- FedEx will accept clinical samples in FedEx Clinical Paks, FedEx Medium Clinical Boxes or FedEx Large Clinical Boxes.²

2. The primary receptacle cannot contain more than 1L of a liquid substance (500 ml if using FedEx).
3. If multiple fragile primary receptacles are placed in a single secondary packaging, they must be either individually wrapped or separated to prevent contact between them.
4. Absorbent material must be placed between the primary receptacle and the secondary packaging. The absorbent material (cotton balls, cellulose wadding, absorbent packets, paper towels) must be in sufficient quantity to absorb the entire contents of the primary receptacle(s) so that any release of the liquid substance will not compromise the integrity of the cushioning material or the outer packaging.
5. The outer packaging must not contain more than 4L or 4kg of material. This quantity excludes ice, dry ice, or liquid nitrogen when used to keep specimens cold.
6. An itemized list of contents must be enclosed between the secondary packaging and the outer packaging.
7. The packaging must successfully pass a 4 ft. drop test (Section 6.6.1 IATA regulations).
8. The UN3373 mark must be displayed on the external surface of the outer packaging (one surface of the outer packaging must have a minimum dimension of 100 mm x 100 mm FedEx minimum is 7"x 4"x 2") on a background of a contrasting color and must be clearly visible and legible. The mark must be in the form of a diamond with each side having a length of at least 50 mm. Lettering must be at least 6mm high.
9. The proper shipping name "Biological Substance, Category B" in letters at least 6mm high must be marked on the outer package adjacent to the diamond shaped UN3373 mark.

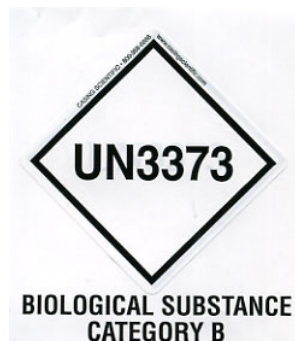

10. If using FedEx, the FedEx USA Airbill, Section 6, Special Handling must be completed with dangerous goods/dry ice information:

Does this shipment contain dangerous goods?

YES- Shipper's Declaration not required

11. The outer container of all diagnostic/clinical specimen packages must display the following:

- a. Sender's name and address
- b. Recipient's name and address
- c. The words "Biological Substance, Category B"
- d. The UN 3373 label

Shipping Requirements Category B or Exempt¹ – Frozen or Refrigerated Specimens:

NOTE: FedEx defers to IATA regulations for the shipping of refrigerated or frozen diagnostic specimens.²

Follow all packaging directions for Category B or Exempt – Ambient Temperature plus:

1. Place ice or dry ice outside of the secondary packaging. Interior supports must be provided to secure the secondary packaging in the original position after the ice or dry ice has dissipated. If ice is used, the outside packaging or overpack must be leak proof. If dry ice is used, the packaging must be designed and constructed to permit the release of CO² gas to prevent a buildup of pressure that could rupture the packaging.
2. Always affix the Class 9, UN 1845 dry ice label as well as the UN 3373, Biological Substance, Category B label to these shipments
3. If using FedEx, the FedEx USA Airbill, Section 6, Special Handling must be completed with dangerous goods/dry ice information:
Does this shipment contain dangerous goods?
 YES- Shipper's Declaration not required
 Enter kg of dry ice used (if applicable)
4. The outer container of all diagnostic/clinical specimen packages must display the following:
 - a. Sender's name and address
 - b. Recipient's name and address
 - c. The words "Biological Substance, Category B"
 - d. The UN 3373 label
 - e. Class 9 label, including UN 1845, and net weight if packaged with dry ice

C Shipping ThinPrep® PreservCyt™ Solution Only (such as from a laboratory to a physician)

Domestic Ground Shipments - Limited Quantities:

Notes:

ThinPrep® PreservCyt™ Solution is classified as a Class 3 Flammable liquid, assigned to Packing Group III (PG III).

49 CFR 173.150 (Limited Quantities) allows ThinPrep® PreservCyt™ Solution in vials to be shipped in Limited Quantities when shipped via ground transportation in a sturdy box. The total volume in a package cannot exceed 5 liters or weigh more than 30 kg (66 lbs). Limited Quantities are exempt from labeling requirements.

Limited Quantity domestic ground shipping recommendations:

1. ThinPrep® PreservCyt™ Solution must be shipped in the vials.
2. Place the vials in a good quality cardboard box, such as the ThinPrep® box that holds 250 vials. Pack vials in a manner (adding protective packing material as necessary) as to limit movement of individual vials.
3. Mark the package as “Flammable liquids, n.o.s., (Methanol Solution), 3, UN1993, Ltd. Qty.” add orientation arrows on the ends, and the Limited Quantity label:

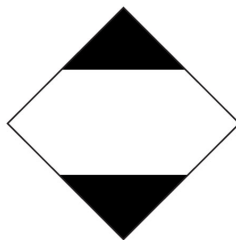

4. Print “UN1993, Flammable liquids, n.o.s., (Methanol Solution), 3, PG III, Ltd. Qty.” on the Shipping papers.

Domestic Ground Shipments - Other than Limited Quantities:

When shipping packages in excess of “Limited Quantity” amounts:

1. Do not include “Ltd Qty” in the wording on the package or on the Shipping papers as indicated in c and d above.
2. Affix a Class 3 “Flammable Liquid” hazard label to the outer package in close proximity of the wording described in “C” above. See the example of the label on the last page of these recommendations.
3. Mark the package as “Flammable liquids, n.o.s., (Methanol Solution), 3, UN1993, Net Qty.”

Domestic Air Shipments:

In addition to 1 and 2 above in Domestic Ground Shipments – Other than Limited Quantities, the following are recommendations for domestic air shipments:

3. Maximum allowable package sizes are:
 - i. Sixty (60) liters (3000-vials) for passenger aircraft, and
 - ii. Two hundred twenty (220) liters (11,000-vials) for cargo aircraft.

4. Single packages containing more than sixty (60) liters (3000-vials) of total product must be clearly marked "FOR CARGO AIRCRAFT ONLY".
5. The vials must be shipped in United Nations (UN) certified 4G packaging for any quantity in an aircraft. (e.g., ThinPrep® PreservCyt™ Solution 250-vial box or equivalent.)
6. A Class 3 "Flammable Liquid" label must be affixed to the outer package near the words "Flammable liquids, n.o.s., (Methanol Solution)".



All Domestic Shipments:

The following are recommendations for all domestic ground and air shipments:

1. If the ThinPrep® PreservCyt™ Solution is shipped in a package also containing non-hazardous material, the hazardous material must be listed first, or be printed in a contrasting color (or highlighted) to differentiate it from the non-hazardous material.
2. The total volume of ThinPrep® PreservCyt™ Solution and the number of vials must appear on the shipping papers.

International Ground Shipments - Limited Quantities:

When shipping internationally, ThinPrep® PreservCyt™ Solution is classified with a primary hazard of Class 3 (Flammable Liquid), and with a secondary hazard of Class 6.1 (Toxic). It is assigned to PG III.

The reference used for the international ground recommendations is the *ADR - European Agreement Concerning the International Carriage of Dangerous Good by Road* (United Nations). A "Limited Quantity" is defined as a package containing a maximum net quantity of 5-liters and not weighing more than 20 kg (40 lbs). The recommendations for international ground shipments are as follows:

1. ThinPrep® PreservCyt™ Solution must be shipped in the vials.
2. Place the vials in a good quality cardboard box, such as the Cytyc box that holds 250 vials. Pack vials in a manner (adding protective packing material as necessary) as to limit movement of individual vials.
3. Mark the package with "UN1992, Flammable liquids, toxic, n.o.s., (Methanol Solution), 3, 6.1, PGIII Ltd. Qty" orientation arrows on the ends and the Limited Quantity label that has a "Y" on it.

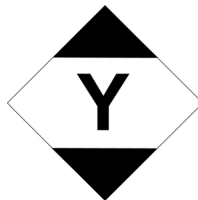

4. The shipping papers should include all the information indicated in "3" above.

International Ground Shipments – Other than Limited Quantities:

1. Do not include “Ltd Qty” in the wording on the package or on the Shipping papers as indicated in c and d above.
2. Affix both a Class 3 “Flammable Liquid” label and a secondary Class 6.1 “Toxic” label to the package adjacent to the markings. (Copies of the labels can be found on the last page of this document.)



Class 6.1 “Toxic” secondary hazard label.

3. Mark the package with “UN1992, Flammable liquids, toxic, n.o.s., (Methanol Solution), 3, 6.1, PG III, Net Qty”.

International Air Shipments:

The references used for the International Air recommendations are: In addition to a and b above in International Ground Shipments, the following are the recommendations for international air shipments:

1. Maximum allowable package sizes are:
 - i. Sixty (60) liters (3000-vials) for passenger aircraft, and
 - ii. Two hundred twenty (220) liters (11,000-vials) for cargo aircraft.
2. Packages containing more than sixty (60) liters of product must be clearly marked “FOR CARGO AIRCRAFT ONLY”
3. The vials must be shipped in United Nations (UN) certified 4G packaging for any quantity in an aircraft. (e.g., ThinPrep® PreservCyt™ Solution 250-vial box or equivalent.) Pack vials in a manner (adding protective packing material as necessary) as to limit movement of individual vials.
4. Limited Quantity exemption can only be used if the package has a maximum net quantity of 2-liters.
5. Packaging manufacturer’s specifications markings are not required when shipping Limited Quantity.
6. Mark the package with “UN1992, Flammable liquids, toxic, n.o.s., (Methanol Solution), 3, 6.1, PGIII, Net. Qty”.
7. When a “Cargo Aircraft Only” marking is required, it must be affixed on the same package surface and near the hazard labels.
8. The shipper is responsible for the completion of a “Shipper’s Declaration for Dangerous Goods” form.

D. Shipping ThinPrep® CytoLyt™ Solution Only (such as from a laboratory to a physician)

Domestic Ground Shipments:

ThinPrep® CytoLyt™ Solution has a flash point of 109° F. For domestic ground transportation only, a flammable liquid with a flashpoint at or above 100° F that does not meet the definition of any other hazard class may be reclassified as a combustible liquid. As such, ThinPrep® CytoLyt™ Solution, shipped via ground, is exempt from the requirements of the DOT Hazardous Materials Regulations.

Domestic Air Shipments:

When shipping ThinPrep® CytoLyt™ Solution via air, follow the Domestic Air Shipments recommendations for Shipping ThinPrep® PreservCyt™ Solution Only that can be found in Section C of this document.

International Ground and Air shipments:

When shipping ThinPrep® CytoLyt™ Solution via ground or air, follow the International Ground or Air Shipments recommendations for Shipping ThinPrep® PreservCyt™ Solution Only guidelines that can be found in Section C of this document.

E. Shipping ThinPrep® CytoLyt™ Solution With Patient Sample (such as from a physician to a laboratory)

Domestic Shipments:

ThinPrep® CytoLyt™ Solution containing a patient sample is classified as a Biological Substance, Category B. Follow the recommendations in Section B of this document.

International Shipments:

ThinPrep® CytoLyt™ Solution containing a patient sample is classified as a Biological Substance, Category B. Follow the recommendations in Section B of this document.

References:

- 49 CFR 100 to 185, *Transportation*
- *Dangerous Goods Regulations*, 56th Edition, 2015, International Air Transportation Association (IATA)
- International Civil Aviation Organization's (ICAO) *Technical Instructions for the Safe Transport of Dangerous Goods by Air*

Foot Notes:

1. See Packing Instruction 650 in the IATA *Dangerous Goods Regulations*
2. FedEx Document 33539PL: "Packaging Clinical Samples" and "Packaging UN 3373 Shipments"

**4. Gynecologic
Sample Preparation**

**4. Gynecologic
Sample Preparation**

Chapter Four

Gynecologic Sample Preparation

SECTION

A

GYNECOLOGIC SAMPLE PREPARATION

Includes cell samples from the ectocervix and the endocervix.

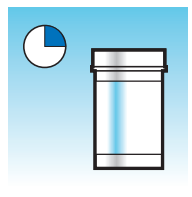
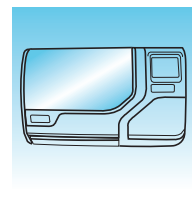
	<p>1. Collection: Deposit the specimen directly into a PreservCyt® Solution vial.</p> <p>Note: Proper rinsing technique of the collection device is very important. See specimen collection instructions on pages 4.3 and 4.4.</p>
	<p>2. Allow to stand in PreservCyt Solution for 15 minutes</p>
	<p>3. Run on ThinPrep® 5000 processor with AutoLoader using Gyn Sequence, stain, and evaluate.</p>



GYNECOLOGIC SAMPLE PREPARATION

SECTION B

COLLECTION PREPARATION

ThinPrep® Collection Techniques

The detection of cervical cancer and its precursors as well as other gynecologic abnormalities is the primary purpose of obtaining a cervical cell sample. The following guidelines are referenced from CLSI Document GP15-A3¹ and are recommended in the collection process for obtaining a ThinPrep Pap test (TPPT) specimen. In general, the guidelines state that it is important to obtain a specimen that is not obscured by blood, mucus, inflammatory exudate or lubricant.

Patient Information

- The patient should be tested 2 weeks after the first day of her last menstrual period, and definitely not when she is menstruating.
Even though the TPPT reduces obscuring blood, clinical studies have demonstrated that excessive amounts of blood may still compromise the test and possibly lead to an unsatisfactory result.²
- The patient should not use vaginal medication, vaginal contraceptives, or douches during the 48 hours before the exam.

Specimen Collection Preparation

- Lubricant jellies should not be used to lubricate the speculum.
Even though lubricant jellies are water soluble, excessive amounts of jelly may compromise the test and possibly lead to an unsatisfactory result.
- Remove excess mucus or other discharge present before taking the sample. This should be gently removed with ring forceps holding a folded gauze pad.
The excess cervical mucus is essentially devoid of meaningful cellular material and when present in the sample vial may yield a slide with little or no diagnostic material present.
- Remove inflammatory exudate from the cervical canal before taking the sample. Remove by placing a dry 2 x 2 inch (5 x 5 cm) piece of gauze over the cervix and peeling it away after it absorbs the exudate or by using a dry proctoswab or scopette.
The excess inflammatory exudate is essentially devoid of diagnostic cellular material and when present in the sample vial may yield a slide with little or no diagnostic material present.
- The cervix should not be cleaned by washing with saline or it may result in a relatively acellular specimen.
- The sample should be obtained before the application of acetic acid.

1. Papanicolaou Technique Approved Guidelines (CLSI Document GP15-A3, 2008)

2. Lee et al. Comparison of Conventional Papanicolaou Smears and Fluid-Based, Thin-Layer System for Cervical Cancer Screening. *Ob Gyn* 1997; 90: 278-284.

**SECTION
C**

SPECIMEN COLLECTION

Collect Gynecologic Sample Using the Broom-Like Device

Physician/clinician instructions for collecting gynecologic samples.

	<p>1. Obtain an adequate sampling from the cervix using a broom-like device. Insert the central bristles of the broom into the endocervical canal deep enough to allow the shorter bristles to fully contact the ectocervix. Push gently, and rotate the broom in a clockwise direction five times.</p>
	<p>2. Rinse the broom as quickly as possible into the PreservCyt® Solution vial by pushing the broom into the bottom of the vial 10 times, forcing the bristles apart. As a final step, swirl the broom vigorously to further release material. Discard the collection device.</p>
	<p>3. Tighten the cap so that the torque line on the cap passes the torque line on the vial.</p>
	<p>4. Record the patient's name and ID number on the vial. Record the patient information and medical history on the cytology request form.</p>
	<p>Note: If the sample is to be processed immediately, allow the sample to stand in the PreservCyt Solution vial for at least 15 minutes before processing. If the sample is to be sent elsewhere for processing, continue with the next step.</p>
	<p>5. Place the vial and requisition in a specimen bag for transport to the laboratory.</p>







Refer to the instructions provided with the collection device for warnings, contraindications, and limitations associated with specimen collection.

4

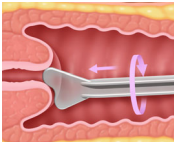
GYNECOLOGIC SAMPLE PREPARATION

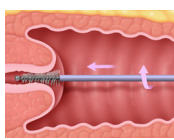
Collect Gynecologic Sample, Using the Endocervical Brush/Spatula Device

Physician/clinician instructions for collecting gynecologic samples.

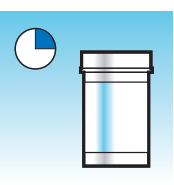
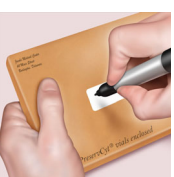
	<p>1. Obtain an adequate sampling from the ectocervix using a <i>plastic spatula</i>.</p>
	<p>2. Rinse the spatula as quickly as possible into the PreservCyt® Solution vial by swirling the spatula vigorously in the vial 10 times. Discard the spatula.</p>
	<p>3. Obtain an adequate sampling from the endocervix using an endocervical brush device. Insert brush into the cervix until only the bottom-most fibers are exposed. Slowly rotate 1/4 or 1/2 turn in one direction. DO NOT OVER-ROTATE.</p>
	<p>4. Rinse the brush as quickly as possible in the PreservCyt Solution by rotating the device in the solution 10 times while pushing against the PreservCyt vial wall. Swirl vigorously to further release material. Discard the brush.</p>
	<p>5. Tighten the cap so that the torque line on the cap passes the torque line on the vial.</p>
	<p>6. Record the patient's name and ID number on the vial. Record the patient information and medical history on the cytology requisition form.</p>
	<p>Note: If the sample is to be processed immediately, allow the sample to stand in the PreservCyt Solution vial for at least 15 minutes before processing.</p> <p>If the sample is to be sent elsewhere for processing, continue with the next step.</p>
	<p>7. Place the vial and requisition in a specimen bag for transport to the laboratory.</p>

Refer to the instructions provided with the collection device for warnings, contraindications, and limitations associated with specimen collection.

SECTION

D

SPECIAL PRECAUTIONS

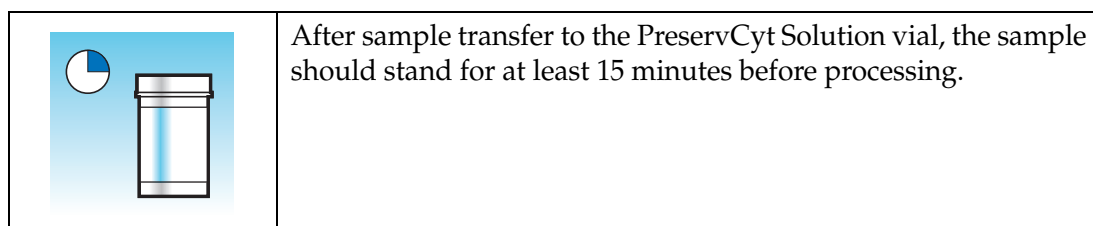
PreservCyt® Solution

For more information on PreservCyt Solution, refer to Chapter 3, PreservCyt® & CytoLyt® Solutions.

Interfering Substances

The Clinical and Laboratory Standard Institute Guidelines (formerly NCCLS) recommend that no lubricant be used during Pap testing.¹

ACOG recommends that care be taken not to contaminate the specimen with lubricant because this may lead to unsatisfactory results.² This applies to both conventional Pap testing and liquid-based cytology.

If you are using a plastic speculum, or in instances where a lubricant must be used, take care not to contaminate the cervix or collection devices with the lubricant. A tiny amount of lubricant may be used, just enough to sparingly coat the speculum with a gloved finger, avoiding the tip of the speculum.

The Clinical and Laboratory Standard Institute Guidelines and ACOG recommend that you not take a Pap during menses.¹⁻²

For samples to be processed on the ThinPrep 5000 processor, lubricants can adhere to the filter membrane and may cause poor cell transfer to the slide. If its use is unavoidable, the lubricant should be used in minimum amounts.

1. Papanicolaou Technique Approved Guidelines (CLSI Document GP15-A3, third edition, 2008)
2. ACOG Practice Bulletin, no. 45, August 2003

4

GYNECOLOGIC SAMPLE PREPARATION

Handling/Disposal

Handle all chemical-containing materials carefully in accordance with safe laboratory practices. When required by reagent composition, additional precautions are marked on the reagent containers.

Dispose of PreservCyt Solution according to your guidelines for disposing of hazardous waste. PreservCyt Solution contains methanol.

SECTION E

SAMPLE PROCESSING TROUBLESHOOTING

Reprocessing a ThinPrep® Pap Test Sample Vial Following an Unsatisfactory Result



Laboratory personnel may reprocess ThinPrep® Pap test specimens where slides have been interpreted as inadequate (“Unsatisfactory for Evaluation”) for diagnosis following cytotechnologist screening. The instructions below must be followed in order to properly reprocess these specimens:

Note: Reprocessing a ThinPrep Pap test specimen may only be performed once.

Note: Good laboratory practices should be followed to avoid introducing contaminants into the PreservCyt Solution sample vial.

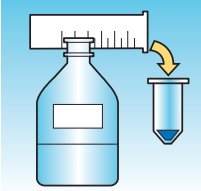
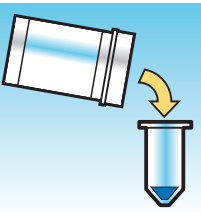
Reprocessing Protocol

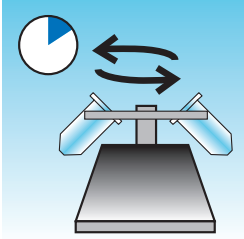
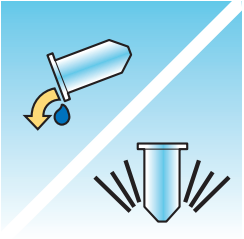
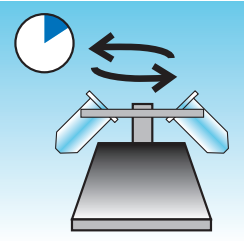
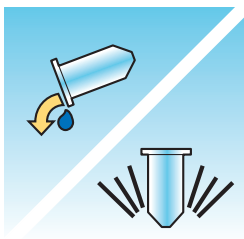
	<p>1 Prepare a wash solution of sufficient volume to add 30 mL to every ThinPrep Pap test specimen being reprocessed. The wash solution is made by mixing 9 parts CytoLyt® Solution with 1 part glacial acetic acid.</p>
	<p>2 Prior to performing this step, assure there is sufficient volume in the ThinPrep Pap test specimen to result in a pellet, following centrifugation. Pour the contents of the ThinPrep Pap test specimen into a centrifuge tube appropriately labeled to maintain chain of custody. Retain the vial.</p>

	<p>3 Pellet the contents of the centrifuge tube by centrifugation at 1200 x g for 5 minutes.</p> <p>Note: Once centrifugation is complete, the cell pellet should be clearly visible but the cells may not be tightly packed together (the pellet may appear fluffy).</p>
	<p>4</p> <ol style="list-style-type: none"> Carefully pour off the supernatant from the centrifuge tube to avoid loss of cells. Dispose of according to local regulations. Vortex the centrifuge tube briefly. Pour 30 mL of the CytoLyt[®] Solution and 10% glacial acetic acid mixture into the centrifuge tube and cap securely. Invert the centrifuge tube by hand several times to mix.
	<p>5 Pellet the cells again by centrifugation—1200 x g for 5 minutes.</p>
	<p>6</p> <ol style="list-style-type: none"> Carefully pour off the supernatant from the centrifuge tube to avoid loss of cells. Dispose of according to local regulations. Vortex the centrifuge tube briefly.
	<p>7</p> <ol style="list-style-type: none"> Using the volume markings on the centrifuge tube, pour the necessary quantity of unused (i.e., containing no patient specimens) PreservCyt[®] Solution to the cells and fill to a final volume of 20 mL. Secure the cap tightly. Invert the centrifuge tube several times to mix and transfer the sample back into the retained specimen vial.

4

GYNECOLOGIC SAMPLE PREPARATION

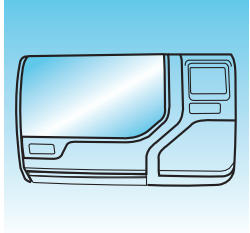
	<p>8 Process the specimen using a ThinPrep® 5000 processor with AutoLoader according to the procedure for running gynecologic specimens. Evaluate the resultant slide according to <i>The Bethesda System for Reporting Cervical/Vaginal Cytologic Diagnosis</i>. If after reprocessing, negative results from specimen do not fit with the clinical impression, a new specimen may be necessary.</p>
---	---

**5. Non-Gynecologic
Sample Preparation**

**5. Non-Gynecologic
Sample Preparation**

Chapter Five

Non-Gynecologic Sample Preparation

**SECTION
A****INTRODUCTION**

This chapter provides instructions for preparing non-gynecologic (non-gyn) samples and making slides with the ThinPrep® 5000 processor with AutoLoader.

For the best results, carefully follow the instructions in this chapter. Because there is biological variability among samples and variability in collection methods, standard processing may not always yield a satisfactory and uniformly distributed preparation on the first slide. This chapter contains troubleshooting instructions for further sample processing to obtain better quality subsequent slides in these cases. This chapter also provides an outline of various sample collection methods and the appropriate procedures for each.

Content found in this chapter:

REQUIRED MATERIALS**SPECIMEN COLLECTION****METHODS OF SAMPLE PREPARATION**

- Concentrate by centrifugation — 600g for 10 min.
- Pour off supernatant and vortex to resuspend cell pellet
- Evaluate cell pellet appearance
- Add specimen to PreservCyt® Solution vial
- Allow to stand in PreservCyt Solution for 15 min.
- Run on ThinPrep® 5000 processor with AutoLoader using Sequence Non-Gyn. Fix, stain, and evaluate.
- Mechanical agitation
- CytoLyt® Solution wash

SPECIMEN PREPARATION GUIDELINES

- Fine Needle Aspirates
- Muroid Specimens
- Body Fluids
- ThinPrep® UroCyt® Specimens

SAMPLE PREPARATION TROUBLESHOOTING

5

NON-GYNECOLOGIC SAMPLE PREPARATION

SECTION B

REQUIRED MATERIALS

From Hologic:

- CytoLyt® Solution
CytoLyt tubes
CytoLyt cups
CytoLyt bottles (bulk)
- PreservCyt® Solution
PreservCyt vials
PreservCyt bottles (bulk)
- Non-Gyn ThinPrep® filters (blue)
- ThinPrep UroCyte® filter (yellow) for the Vysis® UroVysion assay urine specimens
- ThinPrep UroCyte microscope slides for the Vysis UroVysion assay urine specimens
- ThinPrep UroCyte PreservCyt vials for the Vysis UroVysion assay urine specimens
- ThinPrep microscope slides
- ThinPrep 5000 processor with AutoLoader
- Vortexor

Note: Refer to the Ordering Information in this manual for more information about supplies and solutions from Hologic.

From Other Suppliers:

- 50-mL capacity centrifuge (free swing basket)
- Centrifuge tubes, 50 mL
- Plastic transfer pipettes, 1 mL, graduated
- Balanced electrolyte solutions
- Slide staining system and reagents
- Standard laboratory fixative
- Coverslips and mounting media
- Blender (optional)
- Glacial acetic acid (*troubleshooting only*)
- DiThioThreitol (DTT, optional, mucoid samples only)

WARNING: Do not process a cerebrospinal fluid (CSF) specimen or other sample type that is suspected of possessing prion infectivity (PrPsc) derived from a person with a TSE, such as Creutzfeldt-Jakob disease, on a ThinPrep processor. A TSE-contaminated processor cannot be effectively decontaminated and therefore must be properly disposed of in order to avoid potential harm to users of the processor or service personnel.

**SECTION
C****SPECIMEN COLLECTION**

Note: The ThinPrep® 5000 processor with AutoLoader is designed for use with PreservCyt® Solution only. Do not use any other collection or preservative solution with the processor.

Samples to be processed on the ThinPrep processor with AutoLoader will arrive in the lab either fresh or in CytoLyt® Solution. There are preferred collection methods for different sample types. This section will describe the Hologic-recommended procedure as well as alternate collection methods.

WARNING: For washes and lavages, do not expose the patient to CytoLyt Solution.

Fine Needle Aspirate Specimens

The optimal collection technique for FNAs is to deposit and rinse the entire sample into a centrifuge tube containing 30 mL of CytoLyt Solution. A secondary method would be to collect the sample into a balanced electrolyte solution, such as Polysol® or Plasma-Lyte® injection solutions.

Note: Direct smears may be necessary for radiologic-guided FNAs when a rapid analysis of specimen adequacy is required.

Mucoid Specimens

Mucoid specimens are best collected into CytoLyt Solution. If they are collected fresh, CytoLyt Solution should be added as soon as possible. Early addition of CytoLyt Solution preserves the sample and initiates the mucus dissolution process.

Large volume of fresh mucoid specimens (greater than 20 mL) should be concentrated before addition of CytoLyt Solution to the sample.

Fluid Specimens

The preferred method for preparing fluid samples (urinary tract, effusions, synovial, and cyst fluids) is to concentrate the fresh sample before any addition of CytoLyt Solution. If this is not possible and the samples must be preserved for transport to the lab, collect the samples in CytoLyt Solution.

Note: CytoLyt Solution added directly to fluids with high levels of protein may produce some degree of protein precipitation.



NON-GYNECOLOGIC SAMPLE PREPARATION

Note: Fluid collection in CytoLyt® Solution is only considered a collection step and not a wash step. See “CYTOLYT SOLUTION WASH” on page 5.12 for more detail.

The quantity of fluid samples can vary widely from less than 1 mL to 1000 mL and more. Each lab must follow its own procedure for determining the amount of sample to use for processing. If more than one centrifuge tube of sample is used, the cell pellets can be combined after pouring off the supernatant.

Other Sample Types

For non-mucoid brushings and scrapings that are received in PreservCyt® Solution, the sample is ready to be run on the ThinPrep® 5000 processor with AutoLoader.

For non-mucoid brushing and scrapings that are received in CytoLyt Solution, follow the protocol for FNA samples. See “FINE NEEDLE ASPIRATES (FNA)” on page 5.14.

Urine Sample for Use with the Vysis® UroVysion Assay

Follow the instructions that come with the UroCyte Urine Collection Kit. If using the UroCyte Urine Collection Kit, do not exceed a 2:1 ratio of urine to PreservCyt Solution. If the urine volume exceeds 60 mL, pour off excess. A minimum volume of 33 mL of urine is required to perform the Vysis® UroVysion assay.

Other Collection Media

In cases where CytoLyt Solution is contraindicated, balanced electrolyte solutions, such as Plasma-Lyte and Polysol, may be used as collection media for samples to be processed on the ThinPrep 5000 processor with AutoLoader. These solutions are primarily used as media for washings or lavages which contact the patient.

Non-Recommended Collection Media

Hologic does not recommend the use of the following collection solutions with the ThinPrep 5000 processor with AutoLoader. Use of these solutions will produce sub-optimal results:

- Sacomanno and other solutions containing carbowax
- Alcohol
- Mucollexx®
- Normal Saline
- Culture media, RPMI Solution
- PBS
- Solutions containing formalin

Specimens *must* be centrifuged and washed in CytoLyt® Solution and transferred to PreservCyt® Solution prior to being processed on the ThinPrep® 5000 processor with AutoLoader.

Refer to page 5.12 for CytoLyt Solution wash instructions.

Note: See Chapter 3, PreservCyt® & CytoLyt® Solutions, for more information on CytoLyt Solution.

WARNING: CytoLyt Solution is a poison (contains methanol) and it must never come in direct contact with the patient.

SECTION
D

GENERAL STEPS FOR SAMPLE PREPARATION

CONCENTRATE BY CENTRIFUGATION – 600g for 10 minutes

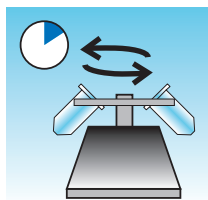

The purpose of this procedure is to concentrate the cellular material in order to separate the cellular component(s) from the supernatant. This step is performed with fresh samples and after the addition of CytoLyt® Solution. When specified in the protocol, centrifuge samples at 600 times normal gravity (600g) for 10 minutes to force the cells in solution into a pellet at the bottom of the centrifuge tube.

Set your centrifuge to the approximate number of revolutions per minute (rpm) to spin the cells at 600g.

Follow these steps to determine the correct setting for your centrifuge:

CAUTION: Check cell morphology on non-critical experimental samples before making any changes to your centrifugation process.

Note: Use of fixed-angle centrifuges is not recommended.

Measure the rotor length of your centrifuge

Use a centimeter ruler to measure the radius of your centrifuge, the distance from the center of the rotor to the bottom of the bucket extended horizontally as shown in Figure 5-1.

5

NON-GYNECOLOGIC SAMPLE PREPARATION

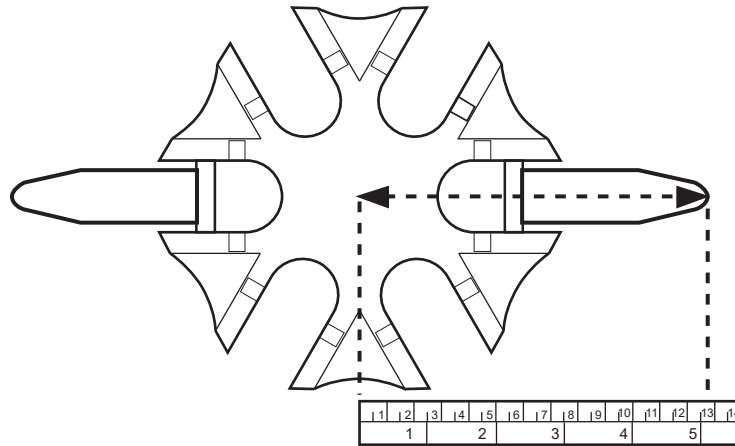

Figure 5-1 Measuring the Centrifuge

Find the radius of your centrifuge in the first column of Figure 5-2. Draw a line from the radius value through the 600 Gravities (g) column and into the rpm column. Read the rpm value from the straight edge as shown in Figure 5-2. Run your centrifuge at this speed to achieve a force of 600g on your samples.

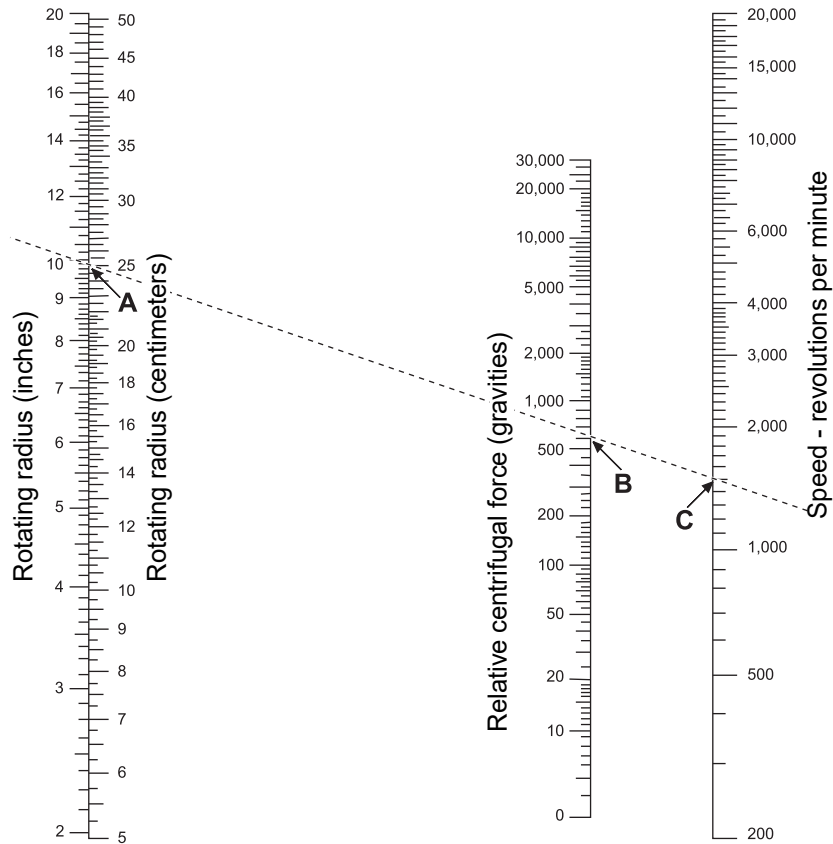
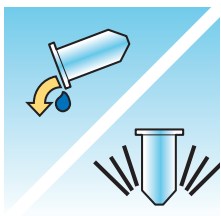

Figure 5-2 Determining the Correct Centrifuge Speed

To reduce the time required for the centrifugation step, operate your centrifuge at 1200g for 5 minutes.

POUR OFF SUPERNATANT AND VORTEX TO RESUSPEND CELL PELLET



Pour off the supernatant completely to effectively concentrate the sample. To do this, invert the centrifuge tube 180 degrees in one smooth movement, pour off all the supernatant, and then return the tube to its original position as shown in Figure 5-3.¹ Observe the cell pellet during inversion to avoid accidental loss of cellular material.

1. Refer to Bales, CE, and Durfee, GR. Cytologic Techniques in Koss, L. ed. Diagnostic Cytology and its Histopathologic Basis. 3rd Edition. Philadelphia: JB Lippincott. Vol. II: pp. 1187–12600 for details.

5

NON-GYNECOLOGIC SAMPLE PREPARATION

CAUTION: Failure to completely pour off the supernatant may produce a sparse sample and an unsatisfactory slide due to dilution of the cell pellet.

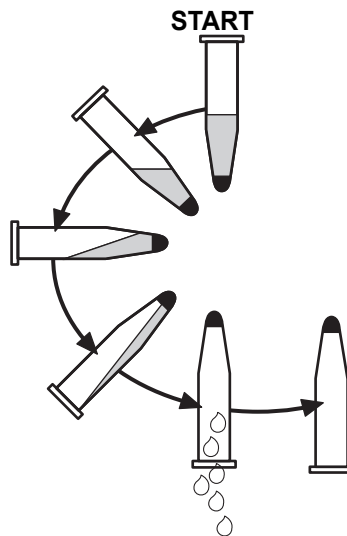
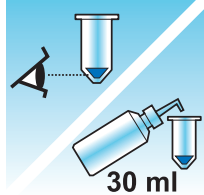

Figure 5-3 Pouring Off Supernatant

After pouring off the supernatant, place the centrifuge tube onto a vortexor and agitate the cell pellet for 3 seconds. Manual vortexing may be achieved by syringing the pellet back and forth with a plastic pipette. The intention of this vortexing step is to randomize the cell pellet before transferring to the PreservCyt[®] Solution vial and to improve the results of the CytoLyt[®] Solution washing procedure.

EVALUATE CELL PELLETT APPEARANCE



Appearance of Cell Pellet	Procedure
<p>Cell pellet is white, pale pink, tan, or not visible.</p>	<p>Add specimen to PreservCyt® Solution vial. See page 5.10 in this chapter.</p>
<p>Cell pellet is distinctly red or brown indicating the presence of blood.</p>	<p>CytoLyt® Solution wash See page 5.12 in this chapter.</p> <ul style="list-style-type: none"> • Add 30 mL CytoLyt Solution. • Concentrate by centrifugation. • Pour off supernatant and vortex to resuspend cell pellet.
<p>Cell pellet is mucoid (not in liquid form). To test for liquid form, draw a small amount of the sample into a pipette and deliver drops back into the tube. If the drops appear stringy or gelatinous, then the mucus must be further liquefied.</p>	<p>CytoLyt Solution wash See page 5.12 in this chapter.</p> <ul style="list-style-type: none"> • Add 30 mL CytoLyt Solution. • Mechanical agitation • Concentrate by centrifugation. • Pour off supernatant and vortex to resuspend cell pellet.

5

NON-GYNECOLOGIC SAMPLE PREPARATION

ADD SPECIMEN TO PRESERVCYT SOLUTION VIAL

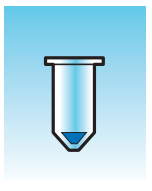
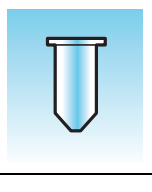
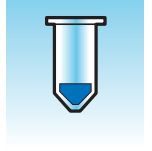

Determine the cell pellet size and refer to the table below:

Size of Cell Pellet		Procedure
	Pellet is clearly visible and the pellet volume is less than 1 mL.	Place the centrifuge tube in a vortexor to resuspend the cells in the residual liquid or mix the pellet by syringing it manually with a pipette. Transfer 2 drops of the pellet to a fresh PreservCyt® Solution vial.
	Pellet is not visible or is scant.	Add the contents of a fresh PreservCyt Solution vial (20 mL) into the tube. Vortex briefly to mix the solution and pour the entire sample back into the PreservCyt Solution vial.
	Pellet volume is greater than 1 mL.	Add 1 mL of CytoLyt® Solution into the tube. Vortex briefly to resuspend the pellet. Transfer 1 drop of the specimen to a fresh PreservCyt Solution vial.

Factors to Consider

The type of pipette that you use may affect the concentration of the sample that is added to the PreservCyt Solution vial, and therefore may affect the volume of sample. Hologic recommends using standard, 1 mL, graduated, plastic pipettes.

If a “Sample Is Dilute” message occurs repeatedly and specimen remains in the specimen tube, increase the number of drops of concentrated sample added to the vial.

Your technique for pouring off the supernatant may also affect the concentration of the sample. If the supernatant is not completely poured off, then additional drops of the sample may be required. The total volume added to the vial must not exceed 1 mL.

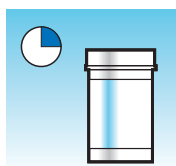
ALLOW TO STAND IN PRESERVCYT SOLUTION FOR 15 MINUTES

After sample transfer to the PreservCyt® Solution vial, the sample should stand for at least 15 minutes before processing to allow the PreservCyt Solution to render the sample non-infectious.

For more information on PreservCyt Solution, refer to Chapter 3, PreservCyt® & CytoLyt® Solutions.

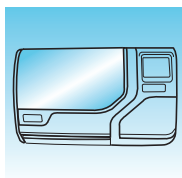
RUN ON THINPREP 5000 PROCESSOR USING SEQUENCE NON-GYN. FIX, STAIN, AND EVALUATE.

After the sample has been in contact with PreservCyt Solution for 15 minutes, it may be processed on the ThinPrep® 5000 processor with AutoLoader. The operator loads the instrument and selects the appropriate sequence for the sample to be processed as described in Chapter 7, Operating Instructions.

At the completion of the process, the operator stains and coverslips the slide according to the procedure in Chapter 10, Staining and Coverslipping.

When the slide is stained and coverslipped, it is microscopically reviewed by a cytotechnologist or pathologist. If the slide appears unsatisfactory after microscopic review, another slide may be made from the specimen using the SAMPLE PREPARATION TROUBLESHOOTING procedures on page 5.22 of this chapter.

MECHANICAL AGITATION

Mucoid specimens require vigorous agitation in CytoLyt® Solution to break up the mucus. Hologic recommends two methods of mechanical agitation:

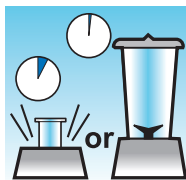
Method A:

Vortex the CytoLyt Solution/sample mixture for at least 5 minutes on a “hands-free” vortexor. The vortexor speed must be adjusted to produce visible agitation to the bottom of the tube.

Method B:

Blend the CytoLyt Solution/sample mixture for a few seconds.

Note: Agitation times for both methods may vary due to differences in specimen consistency.

The blending technique may show fragmentation or disruption of cell architecture. Excessive blending must be avoided.

Vortexing for at least 5 minutes after blending helps break up more mucus.

5

NON-GYNECOLOGIC SAMPLE PREPARATION

CYTOLYT SOLUTION WASH

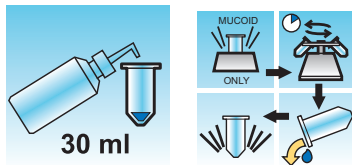

Addition of CytoLyt[®] Solution to cell pellets is required to wash the sample. A **CytoLyt Solution Wash** performs the following functions while preserving cellular morphology:

- Lyse red blood cells
- Dissolve mucus
- Reduce protein precipitation

A **CytoLyt Solution Wash** consists of the following process:

- Adding 30 mL of CytoLyt Solution to a cell pellet
- *Mucoid Specimens Only: Mechanical agitation*
- Concentration by centrifugation — 600g x 10 minutes
- Pouring off the supernatant and vortexing to resuspend the cell pellet

One **CytoLyt Solution Wash** is usually adequate to clean most non-gyn samples. For particularly bloody or mucoid specimens, additional **CytoLyt Solution Washes** may be necessary.

When a sample is collected in CytoLyt Solution at a ratio less than 30 parts CytoLyt Solution to 1 part sample, this is considered a *Collection Step* and not a *Wash Step*. For example, if one collects 15 mL of a sample and adds 30 mL of CytoLyt Solution to this sample, then the CytoLyt Solution: sample ratio is only 2 to 1 and this is considered a sample collection step and still requires a **CytoLyt Solution Wash**.

For more information on CytoLyt Solution, refer to Chapter 3, PreservCyt[®] & CytoLyt[®] Solutions.





**SECTION
E****SPECIMEN PREPARATION GUIDELINES**

The following guidelines outline the preferred methods for preparing the different types of specimens. The methods are described in general terms. For more detailed information about each step, refer to the description of the methods in Section D of this chapter. See Section F for troubleshooting sample preparation.

5

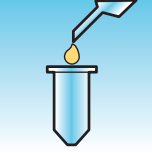
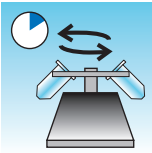
NON-GYNECOLOGIC SAMPLE PREPARATION

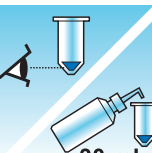
FINE NEEDLE ASPIRATES (FNA)

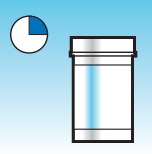
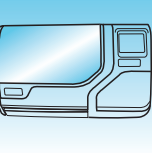
	<p>1. Collection: Collect sample directly into 30 mL of CytoLyt® Solution. If specimen must be collected in an intravenous solution, use a balanced electrolyte solution.</p> <p>Note: If possible, flush the needle and syringe with a sterile anticoagulant solution prior to aspirating the sample. Some anticoagulants may interfere with other cell processing techniques, so use caution if you plan to use the specimen for other testing.</p>
	<p>2. Concentrate by centrifugation — 600g for 10 minutes (page 5.5) or 1200g for 5 minutes.</p>
	<p>3. Pour off supernatant and vortex to resuspend cell pellet (page 5.7).</p>
	<p>4. Evaluate cell pellet appearance (page 5.9). If cell pellet is not free of blood, add 30 mL of CytoLyt Solution to cell pellet and repeat from step 2.</p>
	<p>5. Add appropriate amount of specimen (dependent on the size of the cell pellet) to PreservCyt® Solution vial (page 5.10).</p>
	<p>6. Allow to stand in PreservCyt Solution for 15 minutes (page 5.11).</p>
	<p>7. Run on ThinPrep® 5000 processor with AutoLoader using Sequence Non-Gyn. Fix, stain, and evaluate.</p>

MUCOID SPECIMENS

Mucoid specimens may include respiratory and gastrointestinal specimens.

	<p>1. Collection: Collect sample directly into 30 mL of CytoLyt® Solution. OR Add 30 mL of CytoLyt Solution to the fresh specimen as soon as possible.</p> <p>Note: Large specimens (greater than 20 mL) should be concentrated before addition of CytoLyt Solution to the sample.</p>
<p>Optional:</p>	<p>If DTT is being used with respiratory mucoid samples, add stock before agitation. See the following page for preparation instructions.</p>
	<p>2. Mechanical agitation (page 5.11)</p> <p>Note: Vortex for a minimum of 5 minutes in “hands-free” vortexor.</p>
	<p>3. Concentrate by centrifugation — 600g for 10 minutes (page 5.5) or 1200g for 5 minutes.</p>
	<p>4. Pour off supernatant and vortex to resuspend cell pellet (page 5.7).</p>
	<p>5. Evaluate cell pellet appearance (page 5.9). Confirm the cell pellet is in liquid form. If the cell pellet is not in liquid form, add 30 mL of CytoLyt Solution and repeat steps 2-4.</p>
	<p>6. Add an appropriate amount of specimen (dependent on the size of the cell pellet) to PreservCyt® Solution vial (page 5.10).</p>

5

NON-GYNECOLOGIC SAMPLE PREPARATION

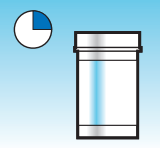
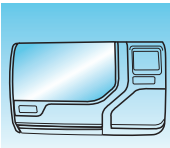
	<p>7. Allow to stand in PreservCyt Solution for 15 minutes (page 5.11).</p>
	<p>8. Run on ThinPrep® 5000 processor with AutoLoader using Sequence Non-Gyn. Fix, stain, and evaluate.</p>

Procedure for the Use of DiThioThreitol (DTT) with Mucoïd Non-Gyn Samples

DTT has been shown to be a reagent that is effective in reducing the amount of mucus in respiratory samples.^{1,2}

DTT stock solution

- Prepare a stock solution by adding 2.5 g DTT³ to 30 mL of CytoLyt® Solution.
- This solution is suitable for use for 1 week when stored at room temperature (15°C–30°C).



Sample preparation

- This procedure is designed for mucoïd non-gyn sample processing. Follow the steps for processing mucoïd specimens on the previous page.
- After sample collection (Step 1), but prior to vortexing (Step 2), add 1 mL of the stock DTT solution to the sample.
- Proceed with the remaining sample processing steps as listed.

1. Tockman, MS et al., 'Safe Separation of Sputum Cells from Mucoïd Glycoprotein' Acta Cytologica 39, 1128 (1995).
2. Tang, C-S, Tang CMC and Kung, TM, 'Dithiothreitol Homogenization of Prefixed Sputum for Lung Cancer Detection', Diagn. Cytopathol. 10, 76 (1994).
3. Available from Amresco, contact a sales representative at 800-448-4442 or www.amresco-inc.com.

BODY FLUIDS

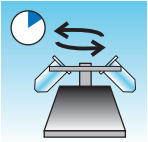
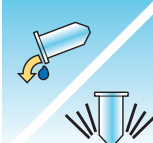
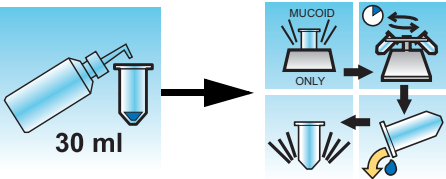
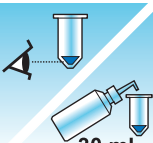
Body Fluids may include serous effusions, urinary and cerebrospinal fluids.

	<p>1. Collection: Collect body fluids fresh.</p> <p>Note: Fluids collected in CytoLyt® Solution also require a CytoLyt Solution wash prior to instrument processing.</p> <p>Note: For extremely bloody fluids (i.e., pericardial), start with only 10 mL of fresh fluid.</p> <p>Note: Urine may be collected into PreservCyt Solution utilizing the ThinPrep® UroCyt® Urine Collection Kit. (Refer to page 5.19 for details.)</p>
	<p>2. Concentrate by centrifugation — 600g for 10 minutes (page 5.5) or 1200g for 5 minutes.</p>
	<p>3. Pour off supernatant and vortex to resuspend cell pellet (page 5.7).</p>
	<p>4. CytoLyt Solution wash (page 5.12)</p>
	<p>5. Evaluate cell pellet appearance (page 5.9). If cell pellet is not free of blood, add 30 mL of CytoLyt Solution to cell pellet and repeat from step 2.</p>
	<p>6. Add an appropriate amount of specimen (dependent on the size of the cell pellet) to PreservCyt® Solution vial (page 5.10).</p>

5

NON-GYNECOLOGIC SAMPLE PREPARATION

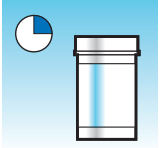
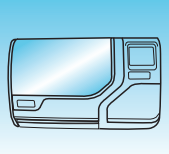
	7. Allow to stand in PreservCyt Solution for 15 minutes (page 5.11).
	8. Run on ThinPrep® 5000 processor with AutoLoader using Sequence Non-Gyn . Fix, stain, and evaluate.

THINPREP® UROCYTE® SPECIMENS

For use with Vysis UroVysion. If performing urine cytology, follow the BODY FLUIDS protocol.

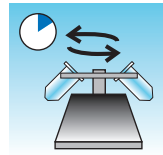
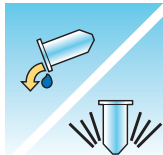
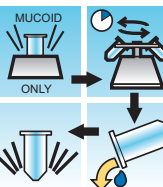
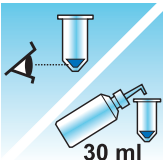
	<p>1. Collection: Collect urine directly into the ThinPrep UroCyt[®] Urine Collection Kit, OR process urine fresh.</p> <p>Note: Fresh urine can be mixed with a 2:1 urine-to-PreservCyt[®] Solution ratio and stored for up to 48 hours before processing.</p> <p>Note: If using the UroCyt[®] Urine Collection Kit, do not exceed a 2:1 ratio of urine to PreservCyt[®] Solution. If the urine volume exceeds 60 mL, pour off excess. A minimum volume of 33 mL of urine is required to perform the Vysis[®] UroVysion assay.</p>
	<p>2. Concentrate by centrifugation (page 5.5). Transfer the sample evenly into two labeled 50-mL centrifuge tubes. Centrifuge at 600g for 10 minutes or 1200g for 5 minutes.</p>
	<p>3. Pour off supernatant and resuspend cell pellet (page 5.7). Resuspension can be done on a vortexor or may be achieved by syringing the pellet back and forth with a plastic pipette.</p>
	<p>4. CytoLyt[®] Solution wash (page 5.12) Add 30 mL of CytoLyt Solution to one 50-mL centrifuge tube and vortex. Transfer the contents of this tube into the second 50-mL centrifuge tube and vortex. The specimen is now combined into one 50-mL tube. The empty tube can be discarded. Centrifuge. Pour off supernatant. Resuspend cell pellet.</p>
	<p>5. Evaluate cell pellet appearance (page 5.9). If the cell pellet is not free of blood, add 30 mL of CytoLyt Solution and repeat from step 4.</p>



5

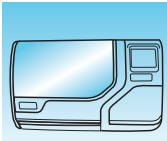

NON-GYNECOLOGIC SAMPLE PREPARATION

	<p>6. Add entire specimen to PreservCyt® Solution vial (page 5.10). Allow to stand in PreservCyt Solution for 15 minutes.</p>
	<p>7. Run on ThinPrep® 5000 processor with AutoLoader using Sequence UroCyt. Fix, stain, and evaluate cytology, OR perform the molecular diagnostic testing according to the manufacturer's instructions for use.</p> <p>Note: UroCyt samples require the yellow ThinPrep UroCyt filter and UroCyt microscope slide for processing.</p>

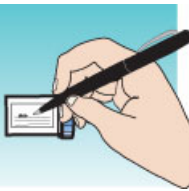
Instructions for Using the ThinPrep UroCyt Urine Collection Kit

Note: The specimen collection cup has a blue cap. The PreservCyt Solution vial has a white cap.

	<p>1. On the specimen collection cup, record patient information in the space provided.</p>
	<p>2. Collect urine in a routine manner. If urine volume exceeds 60 mL, pour off excess. The total volume of urine must not exceed 60 mL. A minimum of 33 mL of urine is required to perform the Vysis® UroVysion assay.</p>
	<p>3. After the urine is collected, carefully pour PreservCyt Solution into specimen cup containing urine. Do not spill PreservCyt Solution.</p>

	<p>4. Tightly secure blue cap on specimen cup to prevent leakage. (Keep turning for another 1/4 inch after you hear the audible click.)</p>
	<p>5. Place cup and absorbent pads into biohazard bag. Tightly seal bag.</p> <p>6. Store between 4°C and 30°C (39°F–86°F). Preferred storage and shipping conditions are on ice packs (e.g., blue ice in styrofoam). Specimen must be processed within 48 hours. Transport the specimen according to your internal procedures.</p>

5

NON-GYNECOLOGIC SAMPLE PREPARATION

SECTION F

SAMPLE PREPARATION TROUBLESHOOTING

Because there is biological variability among samples and variability in collection methods, standard processing may not always yield a satisfactory and uniformly distributed preparation on the first slide. This section contains instructions for further sample processing to obtain better quality subsequent slides in these cases.

After staining, you may observe the following irregularities:

- Non-uniform distribution of the cells in the cell spot that was not accompanied by a “Sample Is Dilute” message.
- Uneven distribution in the form of a ring or “halo” of cellular material and/or white blood cells
- A sparse cell spot lacking in a cellular component and containing blood, protein, and debris. This type of slide may be accompanied by a “Sample Is Dilute” message.

Note: Satisfactory slide appearance is a matter of judgment and experience. Hologic recommends that you check the quality of the slide after staining. If you determine that the slide is unsatisfactory, use the procedures in this section to make additional slides.



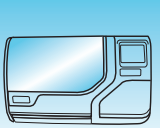
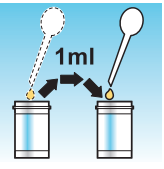
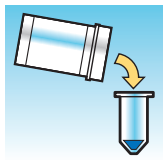
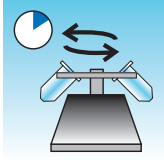
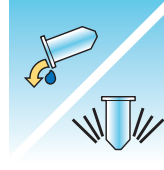
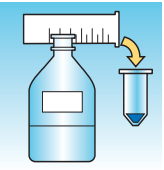

Note: Sample preparation troubleshooting as described here has not been evaluated for ThinPrep® UroCyte® samples.

Bloody or Proteinaceous Specimens

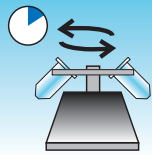
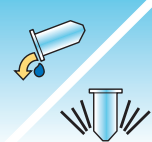
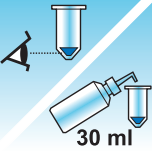

Problem	Procedure	
A. Did the “Sample Is Dilute” message appear during processing? <p style="text-align: center;">NO ↓ YES ⇒</p>	1. Check to see if cellularity is adequate. If not, use more of the pellet if available. Prepare a slide using sequence Non-Gyn. 	
B. Does the slide have an obvious “halo” of cellular material and/or white blood cells? <p style="text-align: center;">NO ↓ YES ⇒</p>	1. Dilute the sample 20:1. Use a calibrated pipette to add 1 mL of sample to a new PreservCyt® Solution vial. Prepare slide using sequence Non-Gyn. If a halo is present on the new slide, call Hologic Technical Service. 	
C. Is the slide sparse and does it contain blood, protein, or non-cellular debris? <p style="text-align: center;">NO ↓ YES ⇒</p>	1. Pour the contents of the PreservCyt sample vial into a centrifuge tube. 	
Call Hologic Technical Service.	2. Concentrate by centrifugation — 600g x 10 min. (page 5.5) or 1200g x 5 min. 	
	3. Pour off supernatant and vortex to resuspend cell pellet (page 5.7). 	
	4. If the sample contains blood or non-cellular debris: Mix a solution of 9 parts CytoLyt Solution to 1 part glacial acetic acid. Add 30 mL of this solution to the sample centrifuge tube. If the sample contains protein: Add 30 mL of saline to the sample centrifuge tube. 	

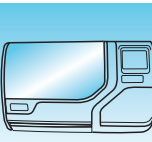
5

NON-GYNECOLOGIC SAMPLE PREPARATION

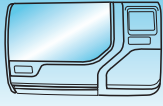
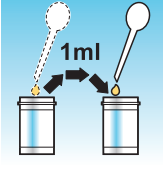
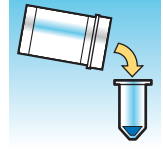
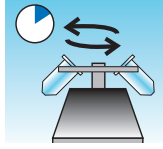
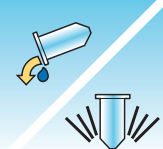

Problem	Procedure	
	5. Concentrate by centrifugation — 600g x 10 min. (page 5.5) or 1200g x 5 min.	
	6. Pour off supernatant and vortex to resuspend cell pellet (page 5.7).	
	7. Evaluate cell pellet appearance (page 5.9). If pellet contains blood or protein, repeat from step 4.	
	8. Add specimen to PreservCyt® Solution vial (page 5.10).	
	9. Run on ThinPrep® 5000 processor with AutoLoader using Sequence Non-Gyn, fix, stain, and evaluate.	
	10. If the new slide is sparse, call Hologic Technical Service (page 12.1).	

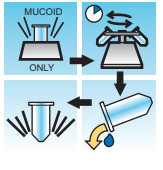
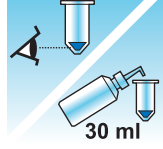
Mucoid Specimens

Problem	Procedure	
A. Did the “Sample Is Dilute” message appear during processing? NO ↓ YES ⇒	1. Check to see if cellularity is adequate. If not, use more of the pellet if available. Prepare a slide using Sequence Non-Gyn. 	
B. Does the slide have an obvious “halo” of cellular material and/or white blood cells. NO ↓ YES ⇒	1. Dilute the sample 20:1. Use a calibrated pipette to add 1 mL of sample to a new PreservCyt® Solution vial. Prepare slide using Sequence Non-Gyn. If a halo is present on the new slide, call Hologic Technical Service (page 12.1). 	
C. Is the slide sparse and does it contain mucus? NO ↓ YES ⇒	1. Pour the contents of the PreservCyt sample vial into a centrifuge tube. 	
Call Hologic Technical Service (page 12.1).	2. Concentrate by centrifugation — 600g x 10 min. (page 5.5) or 1200g x 5 min. 	
	3. Pour off supernatant and vortex to resuspend cell pellet (page 5.7). 	
	4. CytoLyt Solution wash (page 5.12)  	
	5. Evaluate cell pellet appearance (page 5.9). If pellet contains mucus, repeat from step 4. 	

5

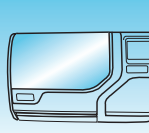
NON-GYNECOLOGIC SAMPLE PREPARATION

Problem	Procedure	
	6. Add specimen to PreservCyt® Solution vial (page 5.10).	
	7. Run on ThinPrep® 5000 processor with AutoLoader using Sequence Non-Gyn. Fix, stain, and evaluate.	
	8. If the new slide is sparse, call Hologic Technical Support (page 12.1).	

Techniques Used in Troubleshooting

Diluting the Sample 20 to 1

To dilute a sample suspended in PreservCyt Solution, add 1 mL of the sample that is suspended in PreservCyt Solution to a new PreservCyt Solution vial (20 mL). This is most accurately done with a calibrated pipette.

You may also simply count drops from an uncalibrated plastic pipette if you know how many drops correspond to 1 mL. To calculate this, count out drops of PreservCyt Solution into a container of known volume. When the known volume is reached, divide the number of drops by the volume (in mL) to get the number of drops that corresponds to 1 mL. Use PreservCyt Solution rather than any other liquid so the drop size will be consistent with the sample drops.

Glacial Acetic Acid Wash for Blood and Non-Cellular Debris

If a sample is found to be bloody during microscopic review, it can be further washed using a solution of 9 parts CytoLyt Solution and 1 part glacial acetic acid. This should only be done after the sample has been in PreservCyt Solution. Do not use directly with fresh specimens; nuclear morphology may not be adequately preserved.

Chapter Six

User Interface

This chapter provides detailed information on the user interface screens and how to use them to operate, troubleshoot and maintain the ThinPrep® 5000 processor with AutoLoader.

The content found in this chapter:

MAIN SCREEN, INSTRUMENT IDLE	6.3
• Status Bar	6.3
• Status Indicators	6.5
• Slides	6.6
• Vials	6.8
• Baths	6.10
• Filters	6.14
• Start Button	6.16
MAIN SCREEN, DURING PROCESSING	6.16
• Processing	6.16
• Processing Complete	6.18
• Pause a Batch	6.19
SWITCH MODES	6.21
ADMINISTRATIVE OPTIONS	6.22
• About button	6.24
• System Settings	6.24
• Set Date	6.25
• Set Time	6.25
• Lab Name	6.26
• Instrument Name	6.27
• Set Sound	6.28
• Alert Tones	6.29
• Language	6.31
• Vial & Slide ID Pre-match	6.31



USER INTERFACE

- Install Printer 6.33
- Tray Processing 6.33
- LIS 6.34
- Clean Screen Button 6.35
- Empty Liquid Waste Button 6.35
- Design Labels 6.36
- Configure Barcodes 6.63
- Change Air Filter Button 6.63
- Clean System Button 6.63
- REPORTS AND LOGS 6.63
- System Events 6.64
- Batch Report 6.66
 - Find a Vial by ID 6.68
 - Save a Report to USB Key 6.71
- Usage Details 6.73
- Carousel Report 6.74
- Vial Event Report 6.76
- Gather Diagnostics 6.77

SECTION A

MAIN SCREEN, INSTRUMENT IDLE

When the ThinPrep® 5000 processor with AutoLoader is powered on and ready for use, the main screen will be displayed.

Status bar - indicates readiness for processing or prompts for user action

Slides status

Vials status

Administrative Options button to access user preferences and settings

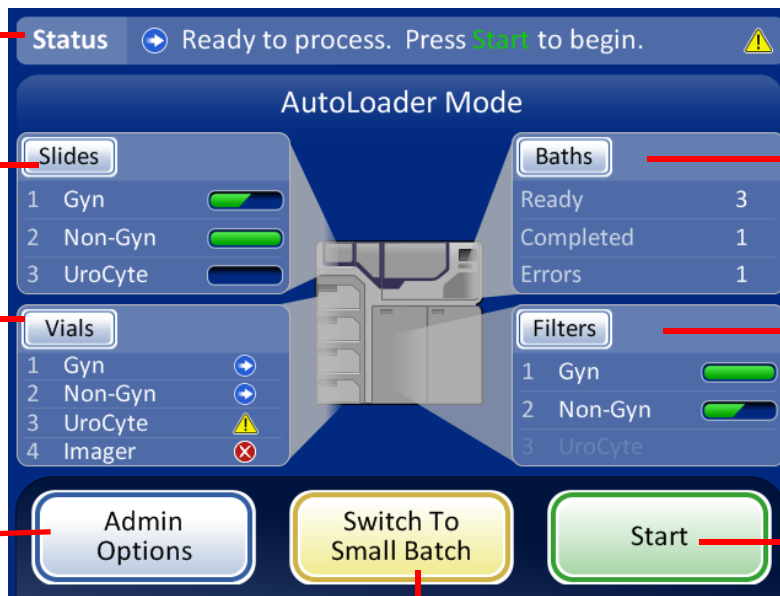

Baths status

Filters status

Start process button

Switch to Small Batch Mode button

Figure 6-1 Main Screen, Status Ready to Process

Status Bar

The status bar indicates whether the system is ready to begin processing. If the system determines that slides, vials, filters and baths are present and match the sample type selected, the status will be **Ready**.



Figure 6-2 System Status Ready

If the system determines operator action is required, a message is displayed on the status bar and the batch will not begin until the item(s) have been resolved. If multiple items need to be resolved, a

6

USER INTERFACE

More Info button is on the status bar. Pressing that will display a message window which lists all items to be seen to. If the **Start** batch button is pressed, the same message window will appear. A batch will not start with unresolved issues.

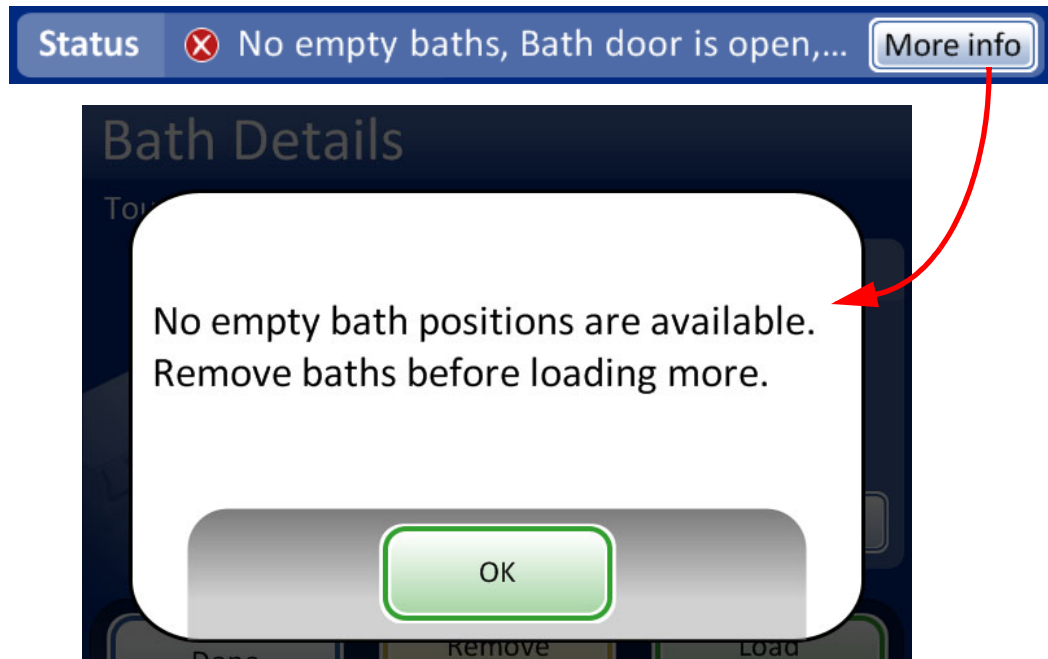









Figure 6-3 System Status Not Ready

Note: Some screen displays also say, “Tap for more information.” Tap that message on the screen to see a message window which provides more information.

Status Indicators

The status indicators aid in identifying whether the system is ready or not to process a batch. A table of the status indicators is shown below.

Table 6.1: Main Screen Status Indicators

Status Icon	Meaning
	Ready for processing
	Completed
	The batch has been paused.
	Not ready or error. Read the message in the status bar to know what issue needs to be resolved
	Warning that the vial tray cannot be processed - usually due to missing or low supply of slides or filters for that sample type, or not enough baths to complete a tray
	Indicates full, partial or empty status of slide cassettes or filter trays
	User action prompt message

6

USER INTERFACE

Slides

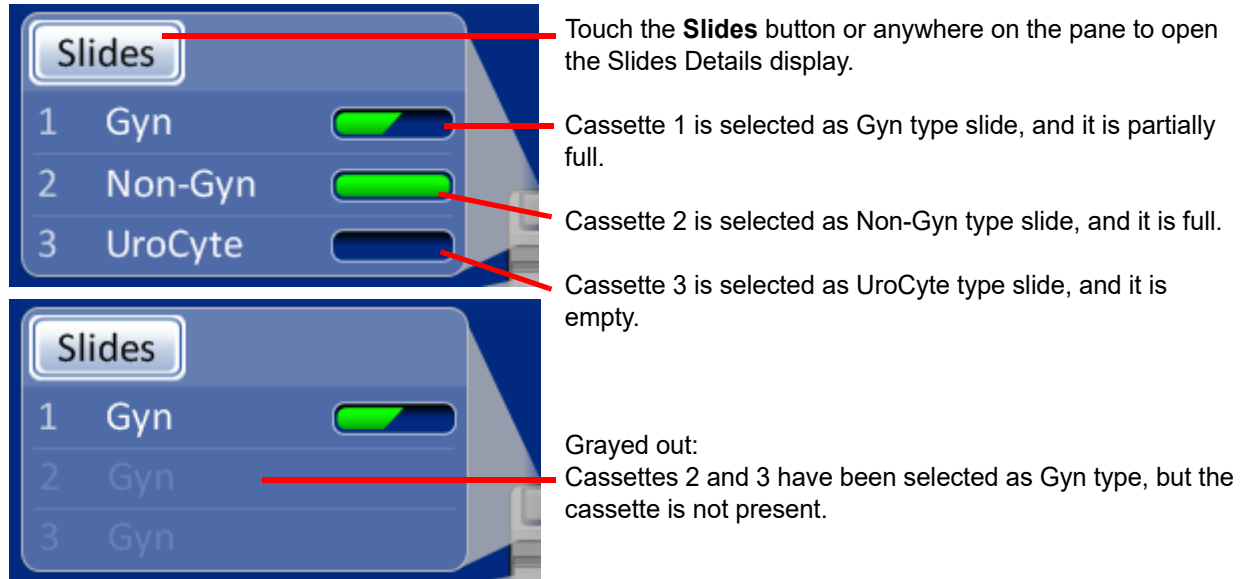

Figure 6-4 Slides Pane on Main Screen

The slides pane shows how the slide cassettes are configured by type and indicates whether the cassettes are full or not. Touch the **Slides** button or anywhere on the slides pane to display the Slide Details screen (Figure 6-5).

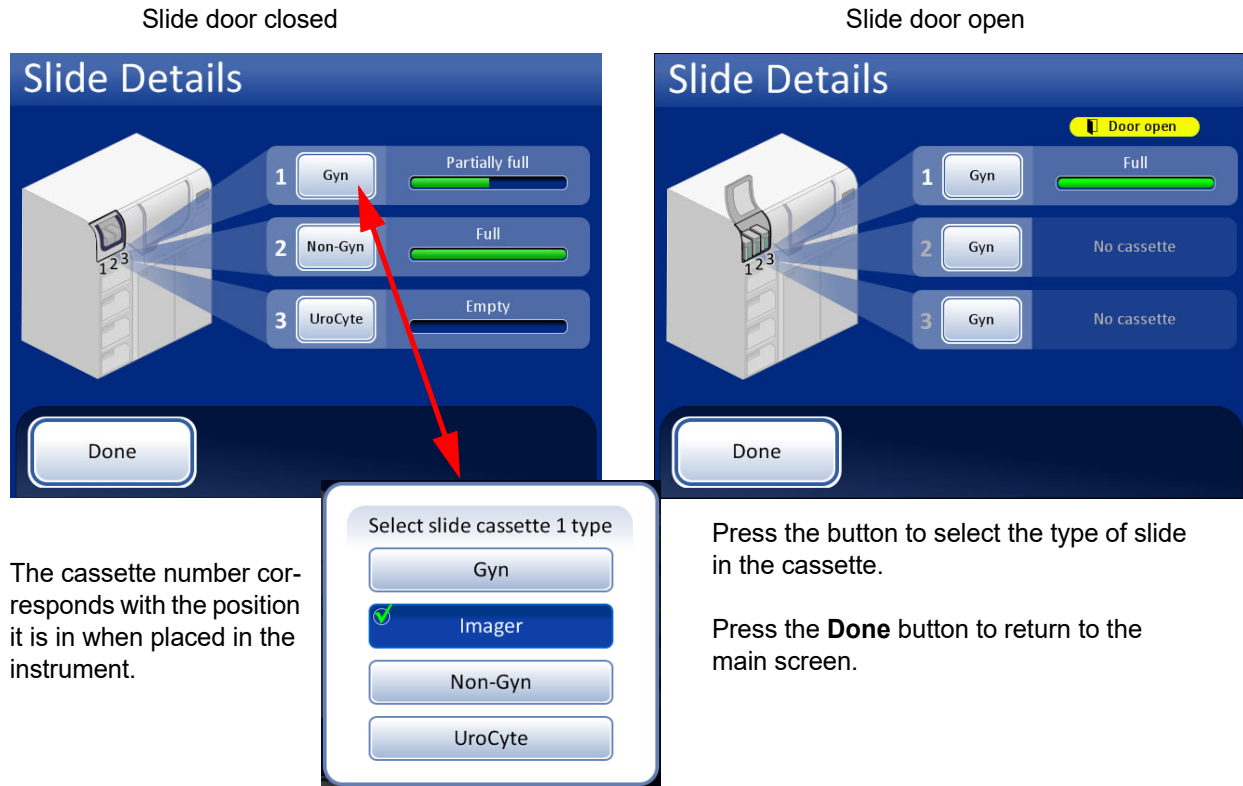

Figure 6-5 Slide Details Display

When a slide cassette is placed into the instrument, the system assumes it is “full” until it checks for the presence of slides in the cassette, which it does when first attempting to retrieve slides from the cassette. The status is “partial” if the cassette is not filled to the top or after the system has used slides out of a cassette. The status is “empty” when the cassette has no slides left. If a slide cassette is not present, the status is “no cassette.”

Touch the button for each cassette bay to display the selection of slide types. Select the exact type by touching the name on the screen. The button label for that cassette will change to reflect the selection. The types of microscope slides are:

- **Gyn** - ThinPrep microscope slides for gynecologic cytology
- **Imager** - slides for use on the ThinPrep Imaging System (gynecologic sample); they bear fiducial marks required by the Imager.
- **Non-Gyn** - microscope slides for general cytology
- **UroCyte** - microscope slides for use in conjunction with the UroCyte® Urine Collection Kit and the Vysis® UroVysion assay

When a cassette is empty, the system will draw off of the next cassette that has the same type of slides in it. If no other cassette has the same type of slides, then the user is notified that there are no slides available.

6

USER INTERFACE

Important: The system can sense whether slides are in a cassette or not, but it cannot sense what type of slide it is. The system only knows what slide type was set previously. The user must always select the slide type.

Vials

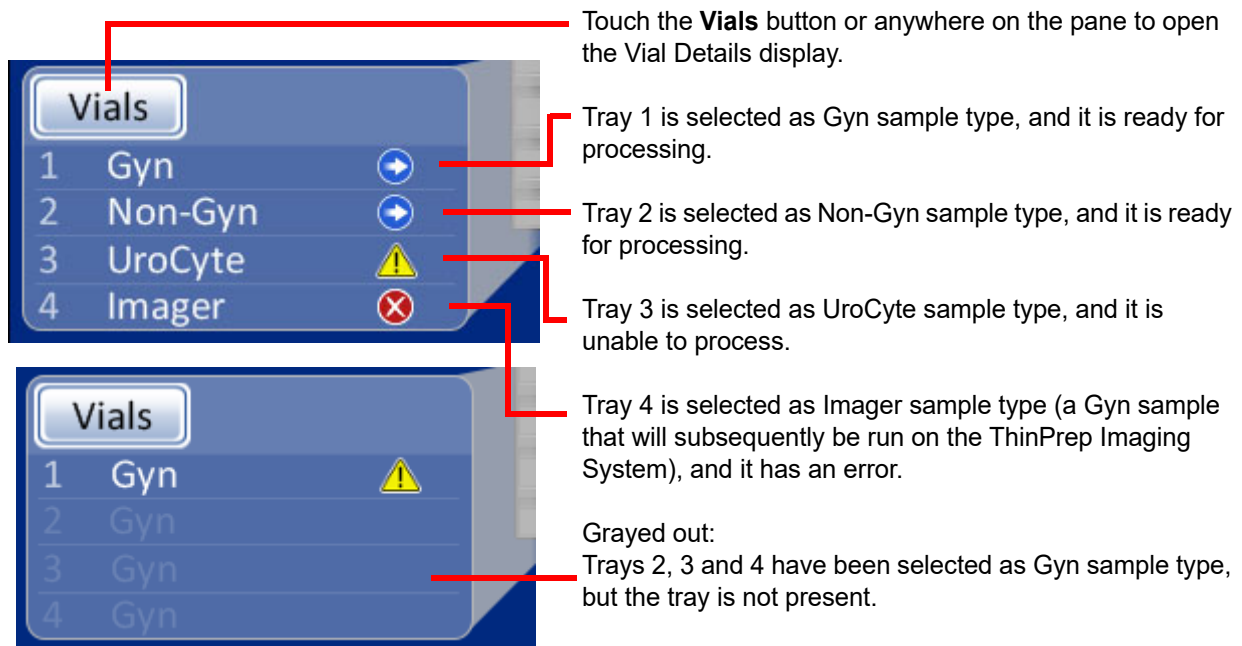
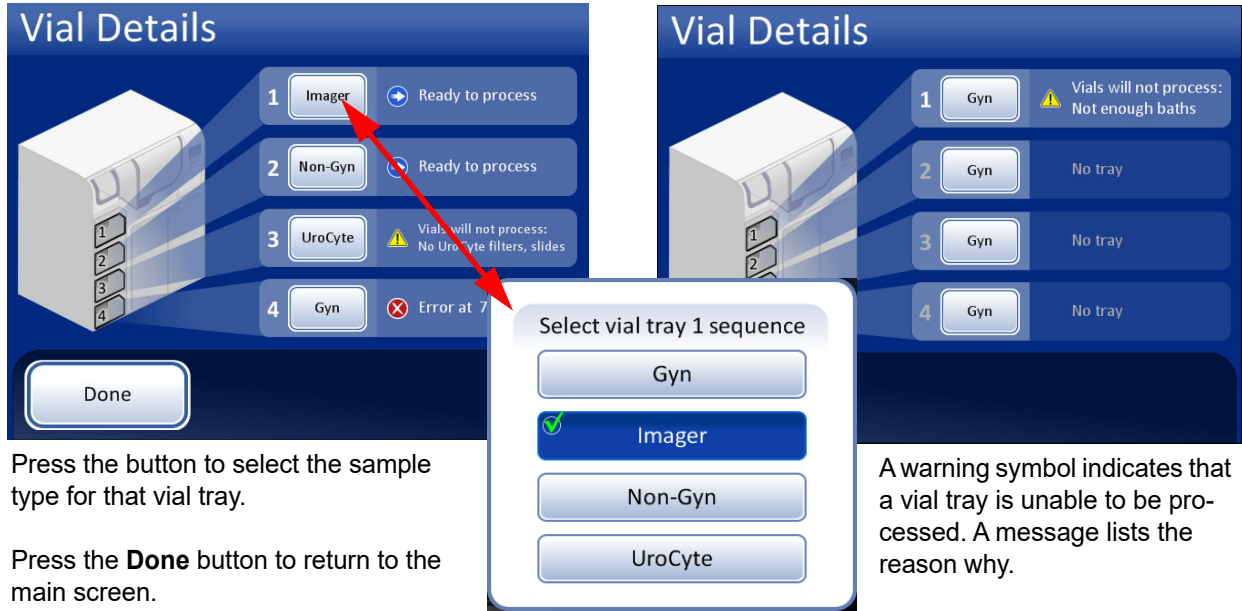

Figure 6-6 Vials Pane on Main Screen

The vials pane shows how the vial trays are configured by sample type and indicates whether the trays are present and ready for processing. Touch the **Vials** button or anywhere on the vials pane to display the Vial Details screen.



Press the button to select the sample type for that vial tray.

Press the **Done** button to return to the main screen.

A warning symbol indicates that a vial tray is unable to be processed. A message lists the reason why.

Figure 6-7 Select Vial Tray Sequence (Sample Type)

Process sequences

Press the button for the vial tray number (1, 2, 3 or 4) and then select the process sequence for the sample vials that will be run in that tray. Only one type of sample may be run in each vial tray.

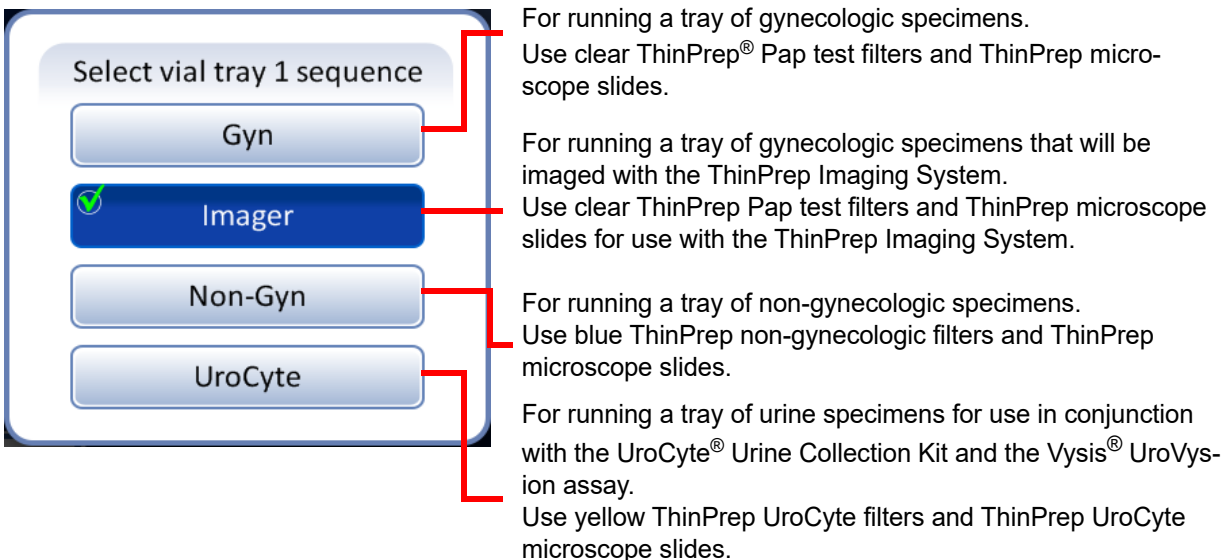

Figure 6-8 Select Vial Tray Sequence

6

USER INTERFACE

Important: The system can sense whether vial trays are present or not, but it cannot sense what type of samples they hold. The system only knows what process sequence type was set previously for that sample tray position. The user must always select the process sequence.

Baths

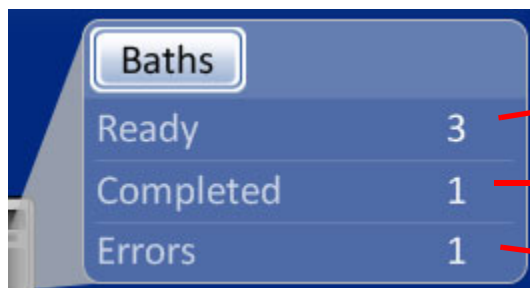

Touch the **Baths** button or anywhere on the pane to open the Bath Details display.

How many baths are in the instrument, ready to process

How many baths are in the instrument that have completed slides and must be unloaded

How many baths are in the instrument that need operator action to correct an error

Figure 6-9 Baths Pane on Main Screen

The baths pane shows how many fixative baths are on board and what condition they are in: ready, completed or with an error. Touch the **Baths** button or anywhere on the baths pane to display the Bath Details screen.



Fixative bath position (8 total)

Fixative bath position during processing

Touch a bath on the touch screen once to display details about that bath. Touch a bath on the touch screen twice to move the bath to the front position (door position).

Bath door position for loading or removal.

The selected bath's position is outlined in green.

Done button to return to main screen

Bath movement commands

Figure 6-10 Bath Details Display



When baths are being moved, the baths door locks while the carousel rotates.

The door unlocks when movement has stopped.

The user can access the bath at the door.

Figure 6-11 A Bath Moving to the Door

6

USER INTERFACE

Fixative bath status

The baths compartment has room for eight fixative baths of 20 slides each. Two baths are needed for each complete vial tray of 40 samples. The processor continuously monitors the status of each bath position. The processor also provides details about the slides in a selected bath.

Slide count - The processor keeps track of the quantity of slides deposited in the slide rack in the selected bath.

First Slide ID - ID of the first slide in the slide rack for the selected bath is displayed.

Vial Tray Info - The processor keeps track of which vial tray provided the samples for the slides in the selected bath. The vial tray number is followed by the approximate position in the that tray. The slides in a bath either come from slots 1–20 in a vial tray or from slots 21–40.

The different status conditions are shown in Figure 6-12.

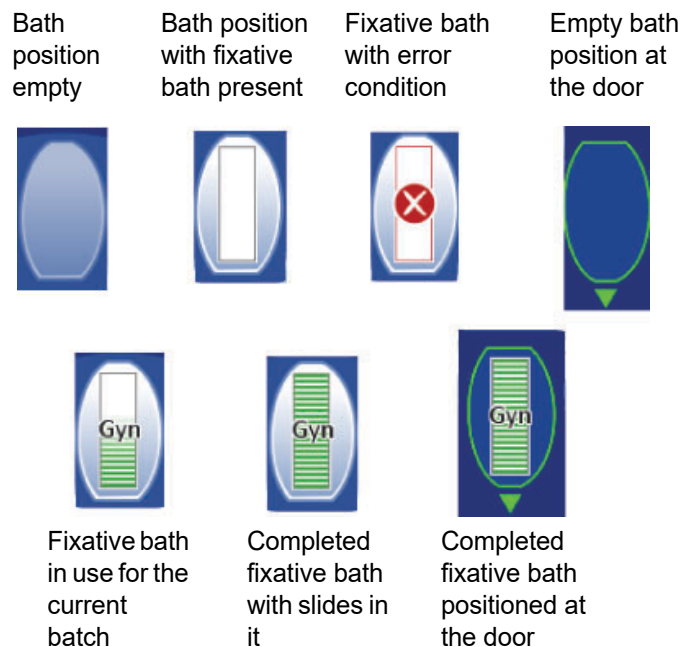
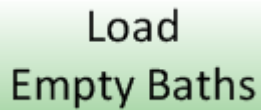

Figure 6-12 Fixative Bath Status - Gyn Slides as Example

Baths movement commands



Move to Front - to move a fixative bath to the door, either touch the **Move to Front** button with the bath selected, or double-touch the position it occupies on the screen display. The system locks the door and moves the position in front of the door. When the door unlocks, it may be opened and the fixative bath removed.

A green rounded rectangular button with a thin green border and a light green gradient background. The text "Load Empty Baths" is centered in a dark green, sans-serif font.

Load
Empty Baths

Load Empty Baths - To load one or more fixative baths into the bath compartment, make sure the door is closed and press the **Load Empty Baths** button. The system locks the door and moves an empty bath position in front of the door. When the door unlocks, open it and slide the fixative bath with staining rack into the position. Close the door. The compartment rotates to the next empty position and then unlocks the door. Continue in this manner until the desired number of baths are loaded. Press the **Done** button when all baths are loaded.

Note: Be sure to remove the bath's evaporative cover before placing it into the processor.

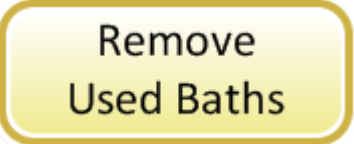
A yellow rounded rectangular button with a thin yellow border and a light yellow gradient background. The text "Remove Used Baths" is centered in a dark yellow, sans-serif font.

Remove
Used Baths

Remove Used Baths - to remove completed fixative baths that are on board the instrument, press the **Remove Used Baths** button. The door locks and a completed bath is moved to the door. The door unlocks. Remove the bath and close the door. The door will lock and the next bath is delivered to the door and the door unlocks. Continue in this manner until all baths are unloaded. Press the **Done** button when the last bath is removed.

6

USER INTERFACE

Filters

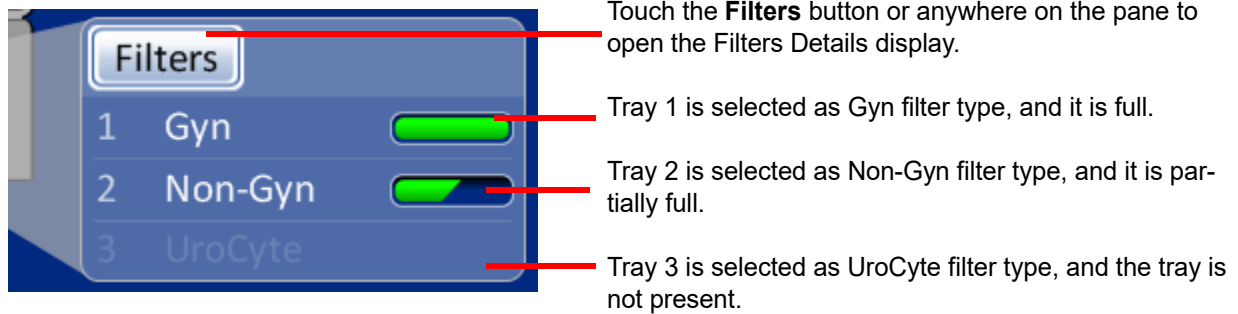

Figure 6-13 Filters Pane on the Main Screen

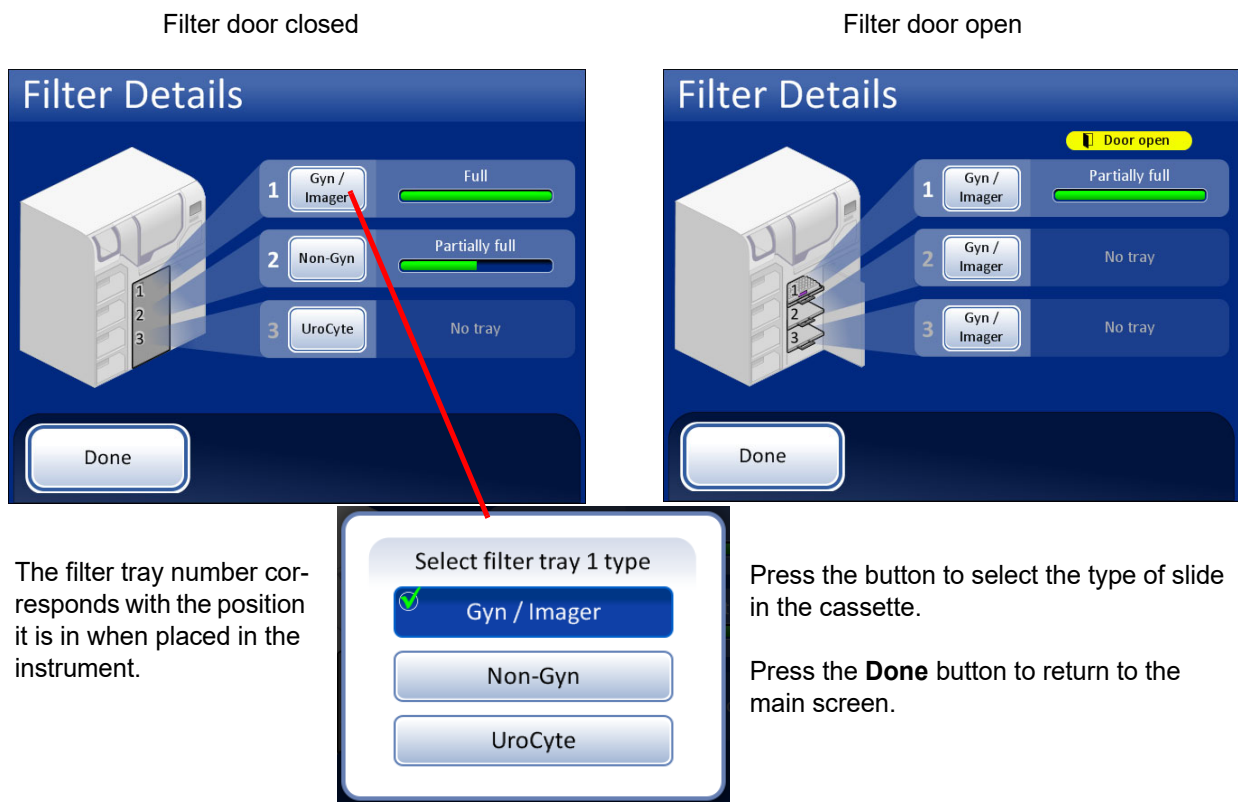

Figure 6-14 Filter Details Display

When a filter tray is placed into the instrument, the system assumes it is “full” until it checks for the presence of filters in the tray. The status is “partial” after the system has used filters out of a tray. The status is “empty” when the tray has no filters left OR if it finds an empty position. If a filter tray is not present, the status is “No tray.”

Touch the button for each filter tray to display the selection of filter types. Select the exact type by touching the name on the screen. The button label for that tray will change to reflect the selection. The types of ThinPrep filters are:

- **Gyn/Imager** - Clear filters for use with gynecologic samples
- **Non-Gyn** - Blue filters for general cytology
- **UroCyte** - Yellow filters for use in conjunction with the UroCyte® Urine Collection Kit and the Vysis® UroVysion assay

When a filter tray is empty, the system will draw off of the next tray that has the same type of filters in it. If no other filter tray has the same type of filters, then the user is notified that there are no filters available.

Important: The system can sense whether filters are in a tray or not, but it cannot sense what type of filter it is. The system only knows what filter type was set previously. The user must always select the filter type.

6

USER INTERFACE

Start Button

To begin a batch, press the **Start** button.



Figure 6-15 Start Button

SECTION B

MAIN SCREEN, DURING PROCESSING

Processing

When the **Start** button is pressed, the doors can be heard to lock. The main screen changes to display a Preparing to Process message, a graphical inventory of consumable items, the **Admin Options** button and a **Pause** button, as shown below.

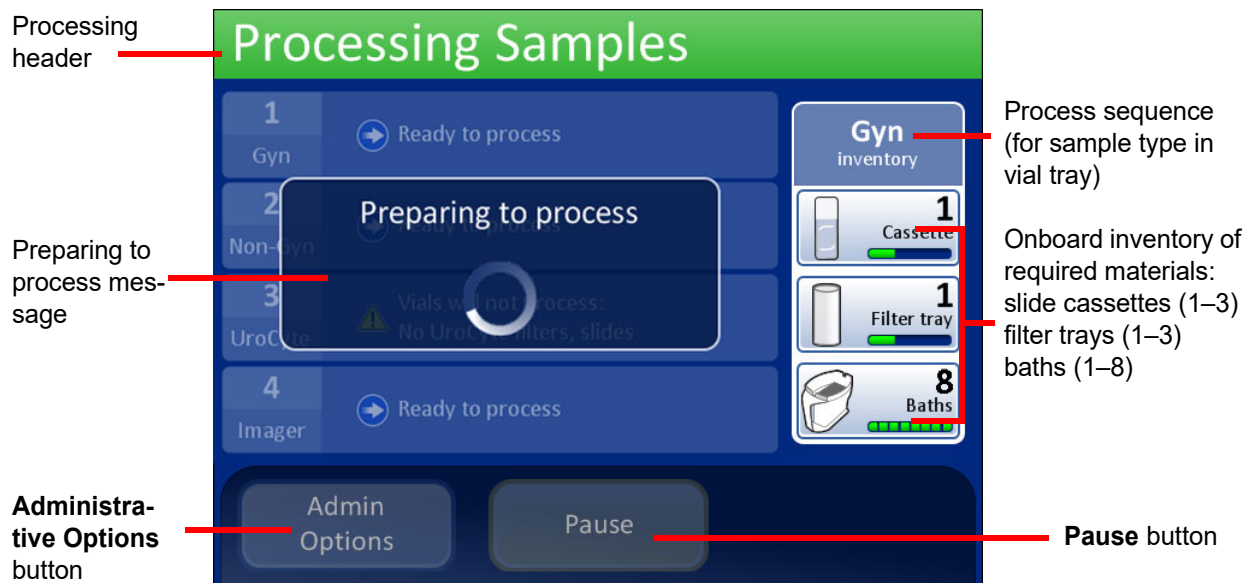

Figure 6-16 Starting Batch Screen

The carousel is rotated and every position is checked to make sure there are no vials on board. Then every slide and filter slot is checked to ensure no material is in the carousel. If the carousel is not completely empty, the batch will not start. The operator will be notified.

The display then transitions to the Processing Samples screen. The processor starts with the topmost tray of vials that it encounters.

The system checks for slides in the cassettes. If cassettes have been newly loaded, this can take one to two minutes while it determines how full the cassettes are. If it is a continued batch, the system already has a running slide count.

The progress bar indicates how many samples of the vial tray have been processed.

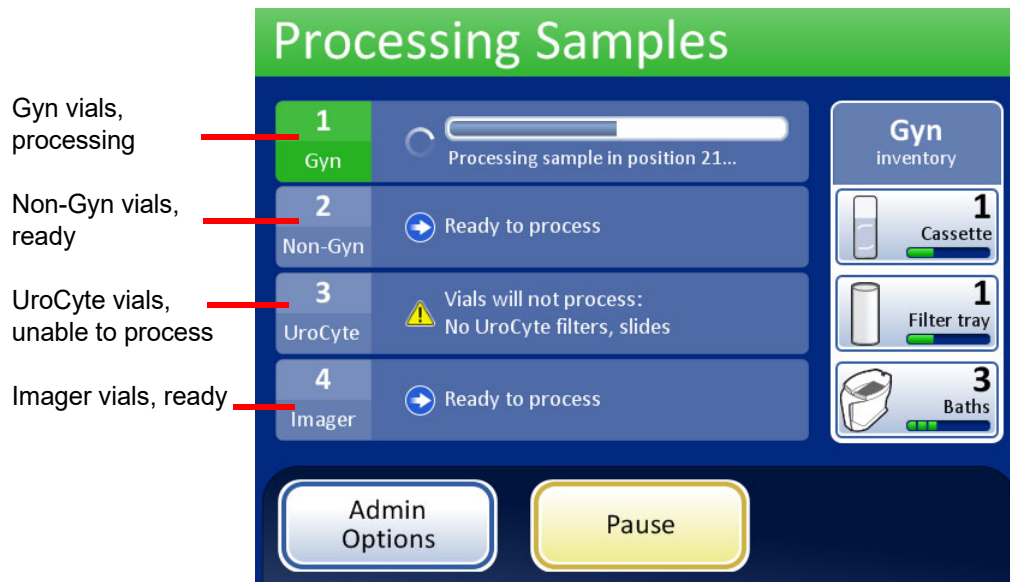

Figure 6-17 Processing Samples Screen

When a tray has been completed the display will change to show that the tray has been processed. The field changes to green and a button to review the batch report becomes available. The status is indicated by a check mark (for OK) or an X (for error).



The tray has completed processing. The check mark indicates OK status. A **View Report** button is available.

Two trays have completed processing. Tray 3 had an unresolved issue and was skipped. Tray 4 is being processed.

Figure 6-18 During Processing with Trays Completed

6

USER INTERFACE

Processing Complete

When a batch has completed processing, the processor returns to an idle state, with a Processing Complete message on the screen. If the audible alert is configured, the instrument will sound. See Figure 6-19. The doors unlock.

To view the batch report, press the **View Report** button. The report will display and there is the opportunity to print the report or save it to USB key via that screen. When the report screen is exited (by pressing the **Done** button), you return to the Processing Complete screen. Refer to “Batch Reports” on page 6.66.

The screen will remain until the operator acknowledges by pressing the **Done** button.

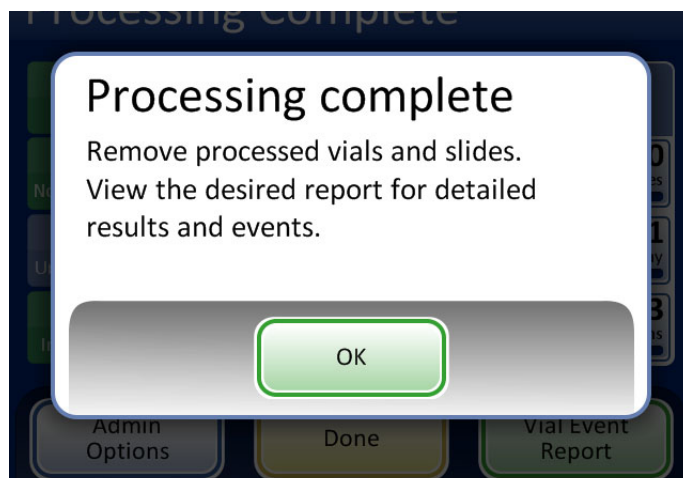

Figure 6-19 Batch Complete Message

Press the **OK** button. The Processing Complete screen is displayed (Figure 6-20).

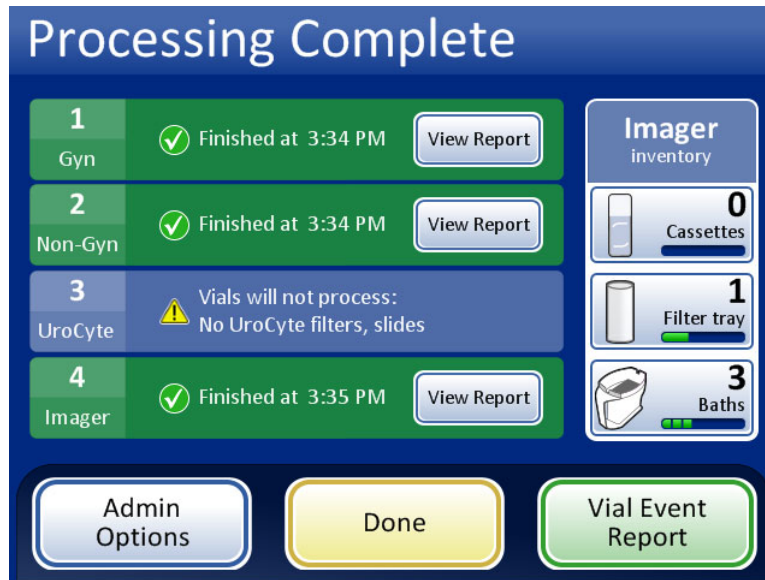

Figure 6-20 Processing Complete Screen

Each batch report can be viewed by pressing the **View Report** button. At that time the report can be printed or saved to USB device. Refer to “Batch Reports” on page 6.66. After viewing each report, this screen will be displayed. To exit this screen, press the **Done** button.

Pause a Batch



Figure 6-21 Pause Button

Note: The following steps are for operator initiation of a batch pause. The system may initiate a pause if it detects low inventory of consumable items. The pause allows the operator to reload slide or filters as required.

A batch may be paused by pressing the **Pause** button.

When the **Pause** button is pressed the system will complete processing the current vial and then pause.

The display header will change color and read “Interrupting” as the processor puts items away and parks the mechanisms. See Figure 6-22.

The Paused screen will display when the processing sequence is safely paused.

6

USER INTERFACE

Note: It may take several minutes for the **Pause** process to complete, depending on which operation of sample processing the system was at when the **Pause** button was pressed. Wait for the user interface to display the Paused screen (Figure 6-22) before attempting to open any doors.

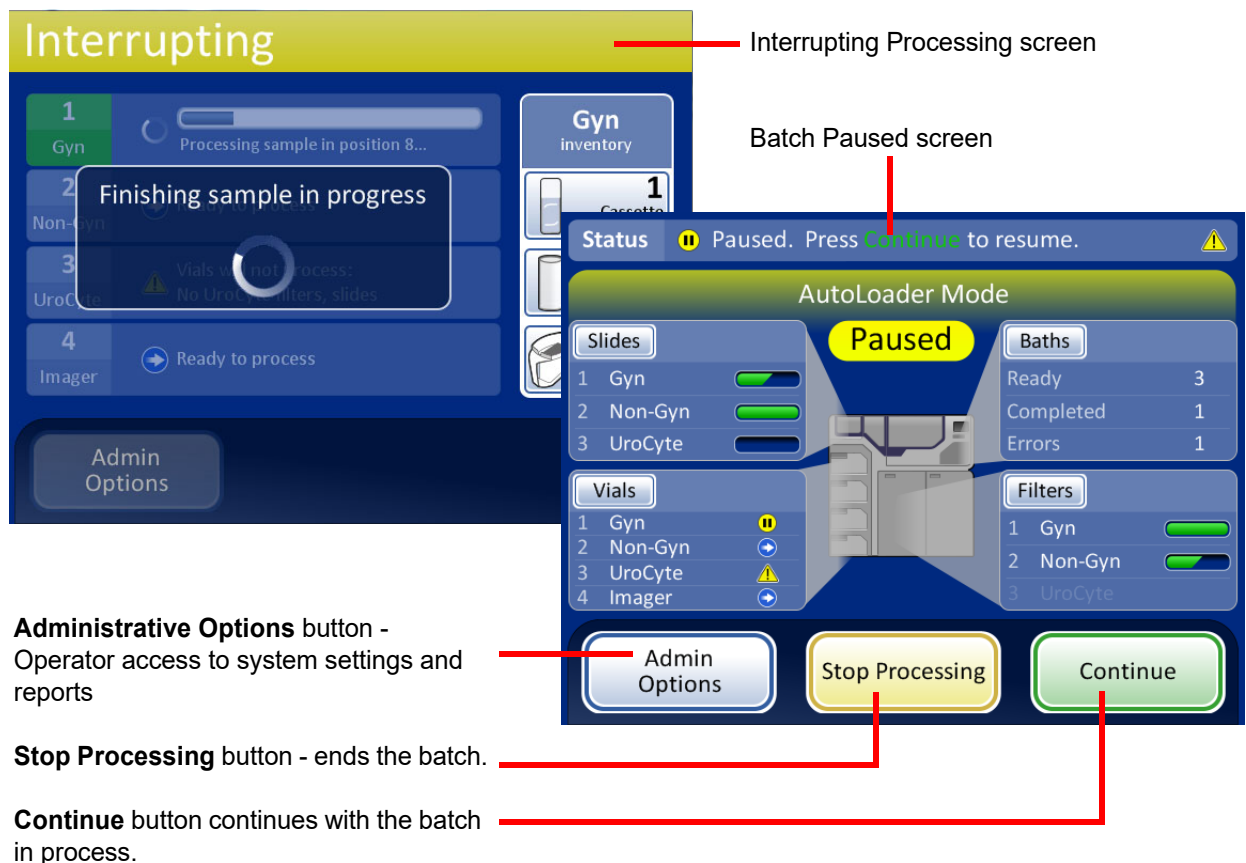

Administrative Options button - Operator access to system settings and reports

Stop Processing button - ends the batch.

Continue button continues with the batch in process.

Figure 6-22 Processing Paused Screen

The doors unlock, with the exception of the processing compartment with the carousel and the door for the vial tray in process.

- Completed slides may be unloaded by removing the fixative bath(s) from the baths compartment. New, empty baths can be loaded.
- Slides and filters can be replenished if necessary. The types may be changed, as long as there is the correct complement to continue processing the vial tray that is paused.
- A completed vial tray may be removed. A new vial tray can be added and the type changed, as long as there are matching filters and slides.
- Admin Options are available.
- Liquid waste and filter waste may be emptied.

Close any open doors and press the **Continue** button when ready to continue with the batch.

Press the **Stop Processing** button to end further processing for that batch. The Processing Complete screen will display. Refer to the next section.

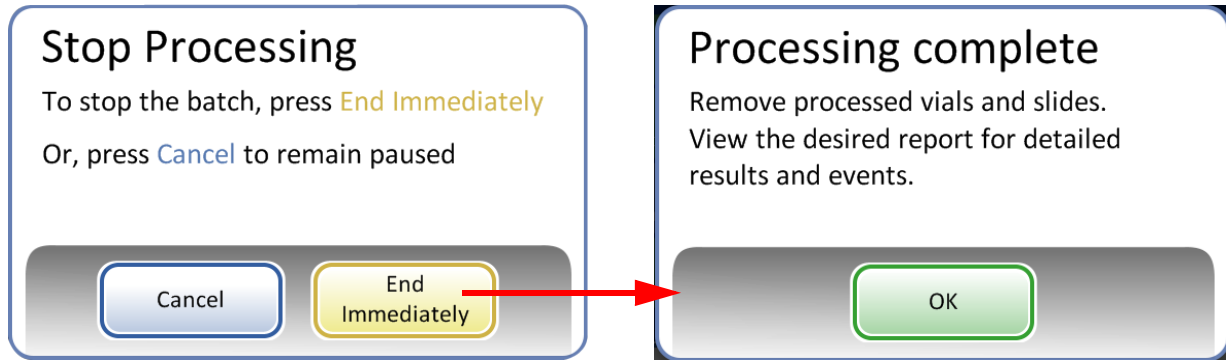

Cancel button will return to the Paused screen.
End Immediately button will end the batch.

Figure 6-23 Stop Processing After Batch Pause

SECTION
C

SWITCH MODES

When the instrument is in an idle state, it can be switched to small batch mode, for running 20 or fewer samples directly on the processing carousel.

See “SMALL BATCH MODE” on page 7.20 for detailed description of using the small batch mode.



Figure 6-24 Switch Mode Buttons

6

USER INTERFACE

SECTION D

ADMINISTRATIVE OPTIONS

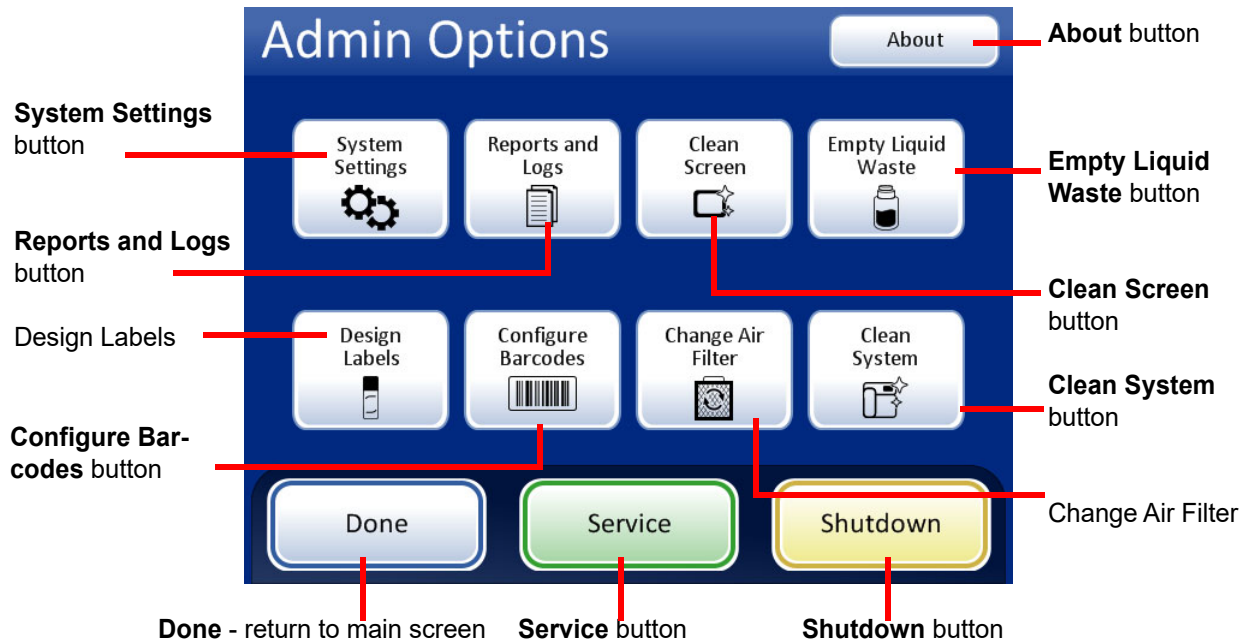

Figure 6-25 Administrative Options Screen

The Administrative Options screen allows user interface with the processor outside of processing samples. From this menu, the operator may:

- Apply or change system settings
- View system logs or print or save them to a USB device
- Disable the touch screen for cleaning
- Empty the liquid waste bottle
- Configure the information etched onto the slide labels
- Configure the rules that the processor uses to check vial IDs and slide IDs
- Run an air flow check feature when changing the filter for the laser fume exhaust
- Move components into position for routing maintenance
- Shut down the instrument
- A Service button is available for Hologic service personnel usage and it is password-protected.

About Button

Press the **About** button to display the serial number for the instrument as well as the software version information. The information displays for several seconds and then the Admin Options screen returns.



System Settings

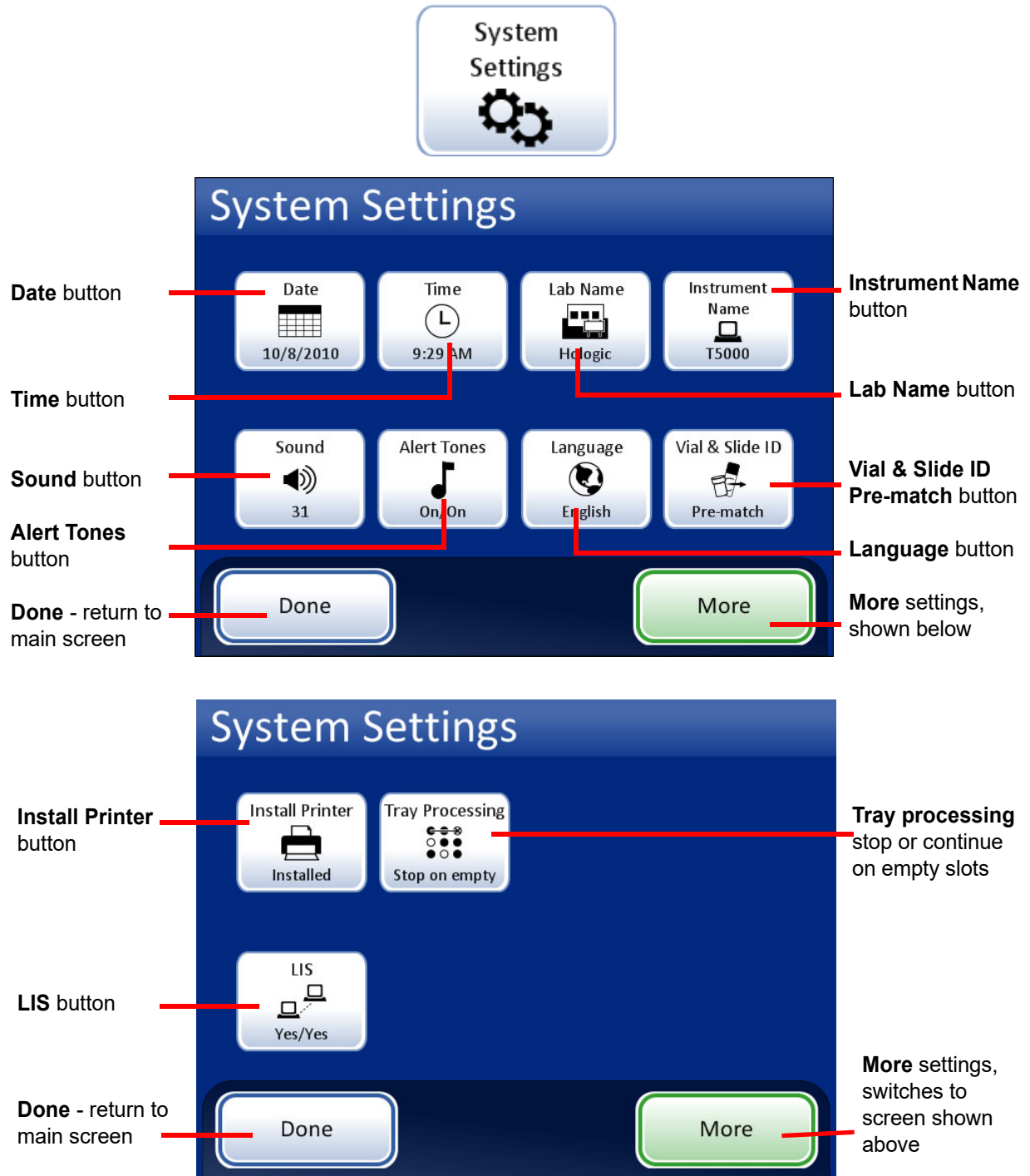

Figure 6-26 System Settings Screens

Set Date



Date button shows current setting.

Figure 6-27 Set Date Button

To change the date (day, month or year) touch the up/down button for that field until the desired value is displayed. Press the **Save Changes** button to return to the System Settings screen. Press **Cancel** to cancel changes and revert to the previous setting. See Figure 6-28.



Figure 6-28 Edit Date Screen

Note: Depending on which language has been selected, the order of the month and day on the display may change to reflect customary usage.

Set Time

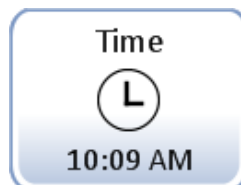

Time button shows current setting.

Figure 6-29 Set Time Button

6

USER INTERFACE

To change the time (hour, minute, meridian), touch the up/down button for that field until the desired value is displayed. For the meridian, press the AM or PM button, as appropriate. Press the **Save Changes** button to save and return to the System Settings screen. See Figure 6-30.

Note: Depending on which language has been selected, the clock on the display may change from 12 hour to 24 hour, to reflect customary usage.

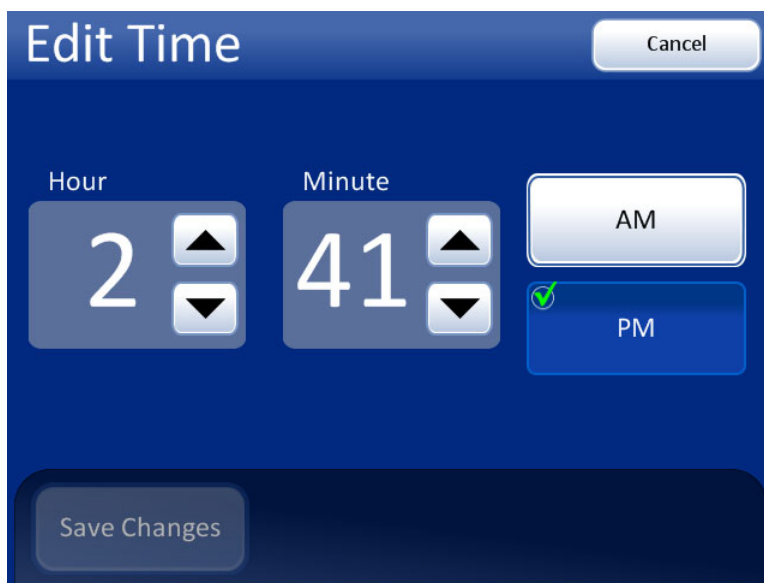
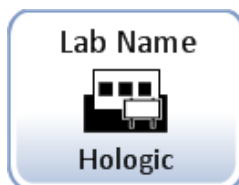

Figure 6-30 Edit Time Screen

Lab Name



Lab Name button shows current setting.

Figure 6-31 Set Lab Name Button

To enter or edit a name for the facility at which the instrument is located, press the **Lab Name** button. Press the letter buttons to enter a name, up to 20 characters long. (Long names that use wide letters may appear cut off on the display, but 20 characters are accepted in the field and will print on the reports.)

See Figure 6-32. To create a capital letter, press the **Shift** button and then press the letter. With the next letter, the system reverts to lowercase. Use the **Space** button for a space and the **Delete** button to remove entered letters.

Press the **abc/123** button to display a keypad screen to enter numbers and characters. Use the **Alt** key to enter characters on the top row. Switch between keyboard and keypad as often as desired before saving changes.

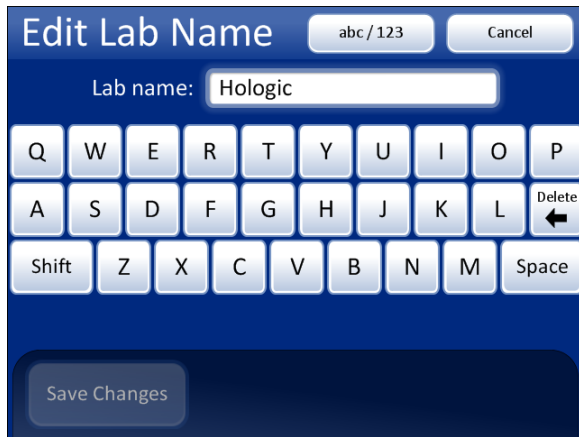

Keyboard display

Shift for a capital letter

Delete to remove entries

abc/123 to display numbers and characters

Cancel to return to System Settings screen.
Reverts to previous entry (if any)

Save Changes to save the entry and return to System Settings screen

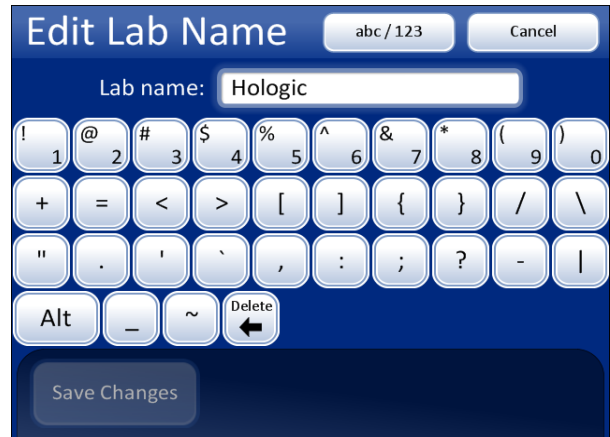

Numbers and characters display

Use **Alt** for characters on the top row

Delete to remove entries

abc/123 to display keyboard

Cancel to return to System Settings screen.
Reverts to previous entry (if any)

Save Changes to save the entry and return to System Settings screen

Figure 6-32 Edit Lab Name Keyboard and Keypad Screens

Instrument Name

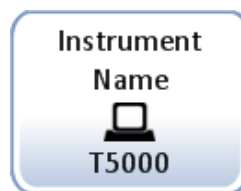

Instrument Name button shows current setting.

Figure 6-33 Instrument Name Button

To enter or edit a name for the ThinPrep 5000 processor with AutoLoader, press the **Instrument Name** button. Press the letter buttons to enter a name, up to 20 characters long. (Long names that use wide letters may appear cut off on the display, but 20 characters are accepted in the field and will print on the reports.)

6

USER INTERFACE

See Figure 6-34. To create a capital letter, press the **Shift** button and then press the letter. With the next letter, the system reverts to lowercase. Use the **Space** button for a space and the **Delete** button to remove entered letters.

Press the **abc/123** button to display a screen to enter numbers and characters. Use the **Alt** key to enter characters on the top row. Switch between keyboard and keypad as often as desired before saving changes.

Press the **Save Changes** button to save and return to the System Settings screen.



Figure 6-34 Edit Instrument Name Screen

Set Sound

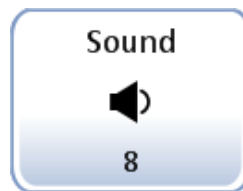

Sound volume button shows current setting.

Figure 6-35 Sound Volume Button

Audible alert tones can be set to signal batch completion and error condition. The volume of the audible alert tones may be increased or decreased using the Sound setting.

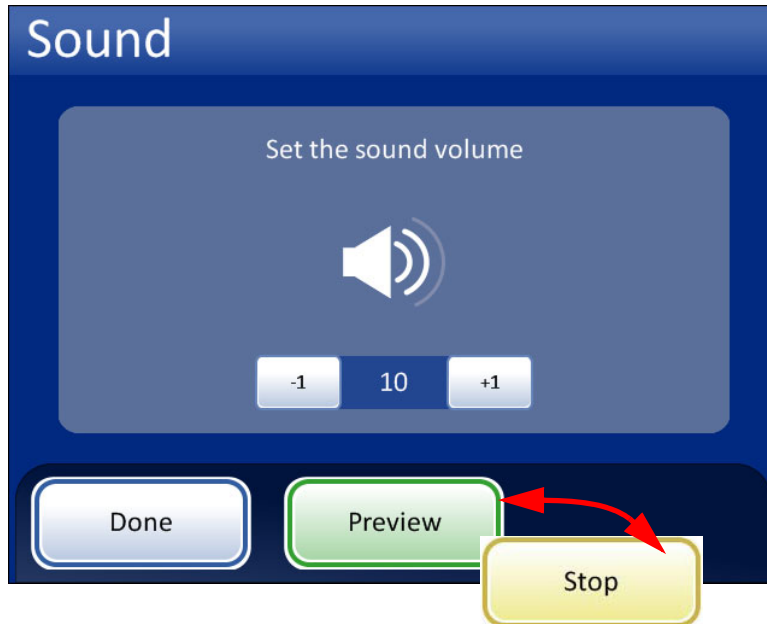

Sound volume
Decrease
Increase

Done - Save setting adjustment and return to System Settings screen

Preview - Press this button to hear the sound at the current volume. The button becomes a **Stop** button, which is pressed to cease the volume test.

Figure 6-36 Sound Screen

Press the **-1** button repeatedly to decrease the volume. Press the **+1** button repeatedly to increase the volume (0 to 31). Test it by pressing the **Preview** button to hear the sound. It will repeat until the **Stop** button is pressed. Continue to adjust and preview the sound volume until it is satisfactory. Press the **Done** button to save the setting and return to the System Settings screen.

Alert Tones



Alert Tones button shows the current setting.

Figure 6-37 Alert Tones Button

Alert tones are audible alarms that sound upon batch completion or during an error condition. Three sounds are offered for each. Select a tone or select the option to turn off any audible alarm for each condition.

Note: The volume of the tones is adjusted by the Sound screen. See the previous section.

6

USER INTERFACE

Having differentiated tones makes it easier to know if the instrument has completed a batch or needs attention. In a setting that might have multiple machines, the different tones can help identify them.



Alert tones for batch completion

Alert tones for an error condition

Turn the option on, and then select a tone. Press the sound icon to hear the tone.

Figure 6-38 Alert Tones Screen for Batch Completion and Error Condition

When a batch completes, the alert tone will sound once.

When an error condition occurs, the alert tone will sound, and then repeat every few seconds. The error message window will have a **Silence Alarm** button that can be pressed to turn the alarm off. (Figure 6-39.)

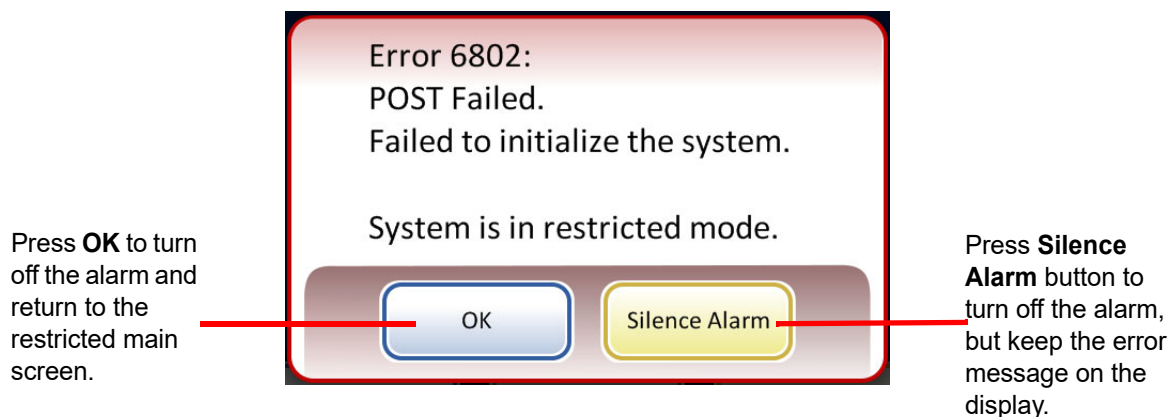

Figure 6-39 Silence Alarm Button

Language



Language button shows the current setting.

Figure 6-40 Language Button

Press the **Language** button to select the language that is displayed on the user interface and on the reports.



Figure 6-41 Select Language Screen

Select a locale for the language. This will apply customary time and date format for that region to the language.

Press the **Save Changes** button to immediately apply the selected language and locale to the system.

Vial & Slide ID Pre-match



The **Pre-match** button shows the current setting.

Figure 6-42 Vial & Slide ID Pre-match Button

6

USER INTERFACE

This system setting is only used for small batch mode, when running 20 or fewer samples directly from the carousel.

If **Vial & Slide ID Pre-match** is selected the system will check the match between each vial/slide ID set in the carousel before beginning to process the batch.

If any of the vial/slide IDs do not match, a dialog box appears, listing the carousel positions of the discrepant vial/slide IDs. See Figure 6-43.

Press **Stop Processing** to cancel the batch and unlock the doors so that the mismatches can be corrected. The window will remain so that the vials and slides can be easily found.

Press **Continue Processing** to proceed with the batch. The vial/slides that are mismatched will not be processed.

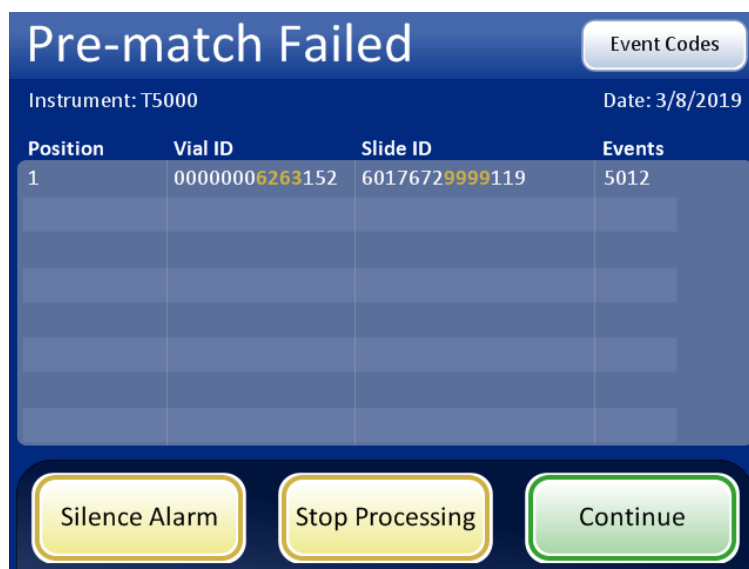

Figure 6-43 Pre-check Failed Screen

If **Vial & Slide ID Pre-match** is not selected the system will check the match between each vial and slide set as it gets to them during processing. A mismatch of the IDs will cause the system to skip the vial and proceed to the next vial that has a matching slide ID. A “Chain of custody is off” message displays on the screen during processing.

Install Printer



Install Printer button shows the current setting.

Figure 6-44 Install Printer Button

If a network printer is installed as part of your system, this function will search the network for its presence and connect to it at the time of setup. If a printer is not installed, or is unavailable to the system, a message will display that a printer could not be found. See Figure 6-45.

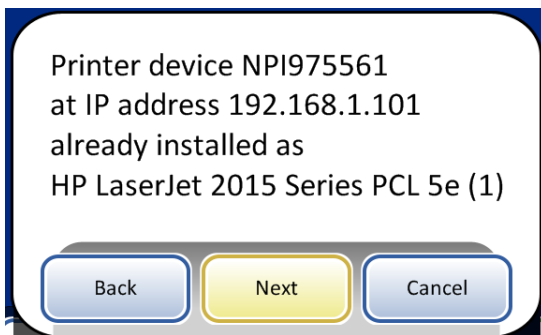

Printer installed message

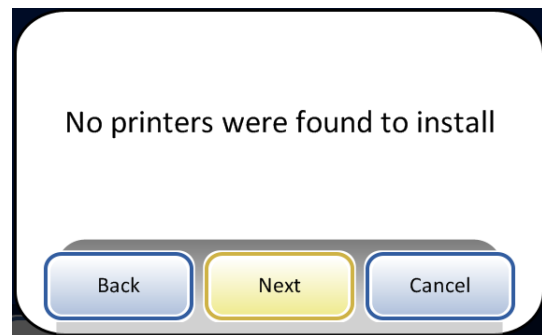

Printer not installed message

Figure 6-45 Install Printer Messages

Note: Multiple instruments may be connected to a single printer.

Tray Processing



During processing, the ThinPrep 5000 processor with AutoLoader moves vials from the vial tray to the carousel. The instrument can be configured to stop loading vials at an empty slot in the vial tray, or to continue past empty slots in the vial tray.

When the setting is "Stop on empty" and the Autoloader encounters an empty slot in a vial tray, the Autoloader stops searching for vials in that vial tray, marks that vial tray as complete, and moves to the next vial tray, continuing through all the remaining vial trays.

6

USER INTERFACE

When the setting is “Search all” and the Autoloader encounters an empty slot in a vial tray, the search continues through all of the remaining slots in the vial tray before moving to the next vial tray, continuing through all the remaining vial trays.

To change the setting, touch the desired option and press **Save Changes**.

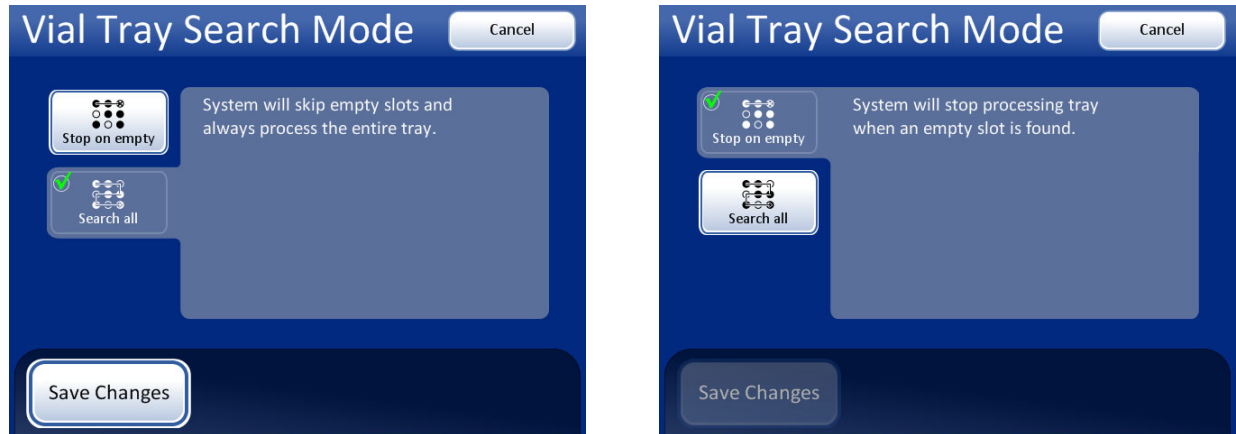
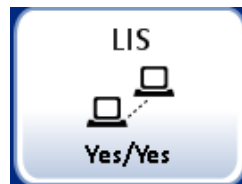

Figure 6-46 Vial Tray Search Mode

LIS (Laboratory Information System)



LIS button shows the current setting.

Figure 6-47 LIS Button

If your system is equipped with the optional LIS interface,

- Batch reports can be uploaded to the NAS (network attached storage).
- Information from your laboratory information system can be included on the slide label design (with some limitations due to space constraints and invalid character usage).
- Slide processing can be configured to always run even if LIS data is not available or to skip vials if LIS data is not available.

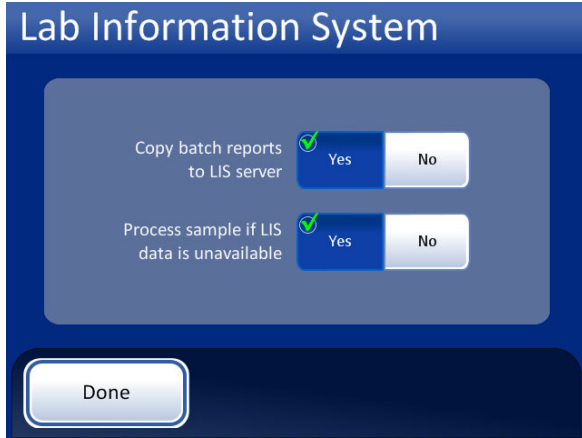

Batch reports will be copied to the NAS for access via the LIS server.

Note: They will also reside in the system database for 8 weeks before being purged.

Vials will be processed even if the label design calls for LIS data that is not available.

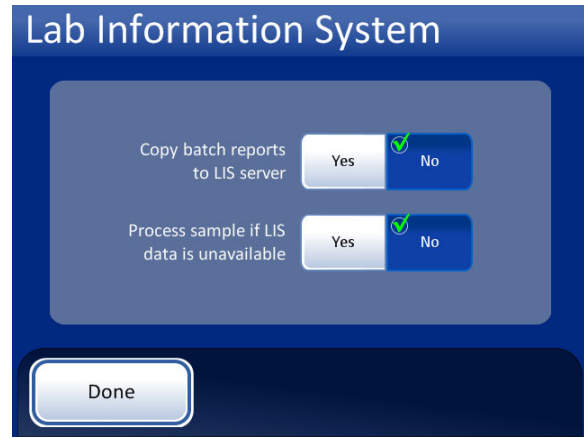

Batch reports will not be copied to the LIS server.

Vials will not be processed if the label design calls for LIS data that is not available. (The vial is returned to the vial tray and the batch report will flag it as error 5201 - failure to read LIS data file.)

Figure 6-48 Lab Information System Selections

Note: The copy batch report and the process sample policy can be changed independently of each other.

Select the settings by pressing the **Yes** or **No** buttons for each field. These settings will persist until the operator changes them.

Clean Screen

This is described in Chapter 8, Maintenance.

Empty Liquid Waste

This is described in Chapter 8, Maintenance.



Design Labels



Figure 6-49 Design Labels Button

The information that is laser-etched onto the microscope slide can be configured with the Design Labels feature. It is a five-step process:

1. Select Slide ID format: OCR Imager, OCR Non-Imager, 1-D barcode or 2-D barcode
2. Select Data that will go on the label (choose: lab name, instrument name, date/time, vial/slide ID, LIS Field 1, LIS Field 2, LIS Field 3, Vial Field 1, Vial Field 2, Vial Field 3, or do not select any field.)
3. Add upper text (choose: lab name, instrument name, date/time, vial/slide ID, LIS Field 1, LIS Field 2, LIS Field 3, Vial Field 1, Vial Field 2, Vial Field 3, or do not select any field.)
4. Add lower text choose: lab name, instrument name, date/time, vial/slide ID, LIS Field 1, LIS Field 2, LIS Field 3, Vial Field 1, Vial Field 2, Vial Field 3, or do not select any field.)
5. Review label design and then save it.

The label design persists until the operator makes any changes. There is a button to reset the design to the default label design, shown in Figure 6-50.



Figure 6-50 Edit Label Design Screen

Set the Configure Barcodes settings and other System Settings, such as instrument name, lab name, and the date, before designing the slide labels. The Design Labels feature can use information from these System Settings.

The slide ID is derived from the sample vial ID. There are length and character restrictions on the resulting slide ID, based on the selected format and the primary vial ID used.

The vial label must be one of the six 1-D barcode symbologies supported (Code 128, Interleaved 2 of 5, Code 39, Code 93, Codabar, or EAN-13/JAN) or one of the two 2-D barcode symbologies supported (DataMatrix or QR Code). No OCR vial label formats may be used.



OCR: Imager

For slides that will be run on the ThinPrep Imaging System Imaging Station, this OCR format is required and the slide is etched in a 7-over-7 format as shown

- Only digits are read from the vial barcode. Non-digit characters are removed.
- If the length is 14, the CRC is assumed to be the last 3 digits. The 11-digit ID is used.
- If the length is between 5–11, zeroes are prefixed as needed to form an 11-digit number.
- If the length is 12 with a leading zero, it is accepted by removing the leading zero.

Figure 6-51 Step 1 - Slide ID Format - OCR: Imager



1-D barcode format

- All characters are read from the vial barcode.
- The data length must be between 5 and 14 characters
- Further slide restrictions may apply to the final format, see Table 6.2.
- The **Next** button prompts to select which 1-D code is used.

To skip the next steps, use the **Finished** button to go directly to the last screen in the sequence, the Review Design screen.

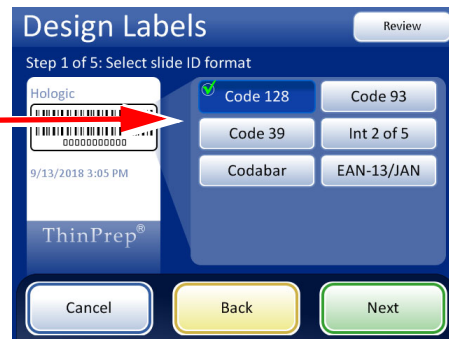

Figure 6-52 Step 1 - Slide ID Format - 1-D Barcode

6

USER INTERFACE



2-D barcode format

- All characters are read from the vial barcode
- The data length for the slide ID must be a minimum of 5 characters. The maximum length for the slide ID in a DataMatrix barcode is likely between 30 and 44 characters. The maximum length for the slide ID in a QR code barcode is likely the 64-character limit of the ThinPrep 5000 processor. Each should be tested. See “Test slide ID settings” on page 6.56
- Further slide restrictions may apply to the final format, see Table 6.2.
- 2-D barcodes do not include human-readable characters, as seen with the format of 1-D barcodes. To have a readable vial ID included on the slide, select “Vial ID” as the field info for step 3 or 4, below.



Figure 6-53 Step 1 - Slide ID Format - 2-D Barcode



OCR: Non-Imager

The slide is etched on one or two rows, depending how many digits are present in the ID.

- Only digits are read from the vial barcode. Non-digit characters are removed.
- The data length must be between 5 and 14 digits.

Figure 6-54 Step 1 - Slide ID Format - OCR: Non-Imager

Table 6.2: Slide Restrictions Based on Barcode Symbology Used

1-D Code 128	All printable ASCII 128 characters are supported. The barcode width varies with content. Max. of 8 alphas or 14 digits will fit on a slide. Mixing will shorten the max. length.
1-D EAN-13/JAN	Supported characters are 0–9. The code must be 13 digits.
1-D NW7	Supported characters are - + \$ / : . and digits 0–9. A maximum of 9 characters will fit on a slide
1-D Interleaved 2 of 5	Only digits are supported. A maximum of 14 digits, including an optional check digit, will fit on a slide.
1-D Code 39	Supported characters are A–Z, 0–9, - + \$ / % 'space' Maximum of 6 characters will fit on a slide.
1-D Code 93	All printable ASCII 128 characters are supported. A maximum of 8 characters will fit on a slide.
2-D QR Code	All printable ASCII 128 characters are supported. A maximum of 64 characters may be used.
2-D datamatrix	All printable ASCII 128 characters are supported. The format is a 12x36 datamatrix, and the maximum is between 30 and 44 characters.

6

USER INTERFACE

Select the data and format for the data to appear on the slide. To leave an area on the slide blank, do not select a data type.



LIS fields are available only when LIS is enabled. When using an LIS or Vial ID/Slide ID field, the **Next** button prompts you to select the type of data.



The Vial Field buttons are available only when the instrument is configured for a vial label that has additional information besides the accession ID. Refer to “Configure Barcodes” on page 6.42.

If your facility uses different IDs for Vial IDs and Slide IDs, the Vial/Slide ID can be a text version of the same slide ID in a barcode, or it can be the accession ID portion of the vial ID.

Figure 6-55 Step 2 - Select Data

The data field under the slide ID can be a barcode or text. The upper text, and the lower text are each text fields. Select the size for the text.



Figure 6-56 Select the size of text on the slide label



Figure 6-57 Step 3 - Add Upper Text



Figure 6-58 Step 4 - Add Lower Text

6

USER INTERFACE



Figure 6-59 Step 5 - Review Design and Save Changes

When label type is selected from the Admin Options screen, the current design will be etched onto the microscope slides.

Note: This is only for the ThinPrep 5000 processor with AutoLoader. If samples are to be processed directly from the carousel in small batch mode, the slides need to be labeled or etched *prior* to processing.

Configure Barcodes



The ThinPrep 5000 processor compares the vial ID with a slide ID. The Configure Barcodes option establishes the ways that the processor will compare the ID information.

The Configure Barcodes settings are a series of questions about how sample vials are labeled when the vials are prepared for processing and a series of questions about how a slides are labeled in your laboratory.

Note: Some barcode configuration options described in this operator's manual may not appear on the screen display for an instrument. The screen display only shows the options available for that particular instrument. For example, ThinPrep 5000 processors with a particular scanner

installed cannot read 2-D barcodes on vial labels, and a particular scanner reads a maximum of five types of 1-D barcodes in vial labels.

The Configure Barcodes settings require that a portion of the information in a vial ID is also used on a slide label. The vial ID can be the same ID that is used on a slide. The slide ID must be a minimum of 5 characters and a maximum of 64 characters, but the format used for the slide ID adds its own requirements. For example, in the OCR: Imager format, the slide ID must be 14 characters, or for a 1-D Code 128 barcode to be legible on the slide, the slide ID can be a maximum of 14 numbers or 8 alpha characters. Generally, the 2-D barcode formats can use more characters in the slide ID than the 1-D barcode or OCR formats.



Figure 6-60 Configure barcodes screen

There are separate sections for configuring the vial ID and the slide ID. In each section, information about the IDs must be entered. Each section ends with a screen with a **Test Configuration** or **Test Settings** button that lets the instrument scan example labels from a vial and/or slide to check that the ThinPrep 5000 processor is configured to read the ID labels used in your lab. The screen displays are designed to guide the operator through the sequence of steps to configure all of the barcode information. The sequence of steps is different if the slide IDs are exactly the same as the vial IDs, if the slide labels are laser-etched by the AutoLoader, and if the slide labels are pre-applied. Each of the steps is described below, followed by the full sequence of steps for configuring the vial ID and the slide ID.

6

USER INTERFACE

Configure Vial ID

The ThinPrep 5000 processor can be set up to read vial IDs as 1-D barcodes or 2-D barcodes. Select 1-D barcode or 2-D barcode, and then select the type(s) of barcodes used for vial IDs at your facility.

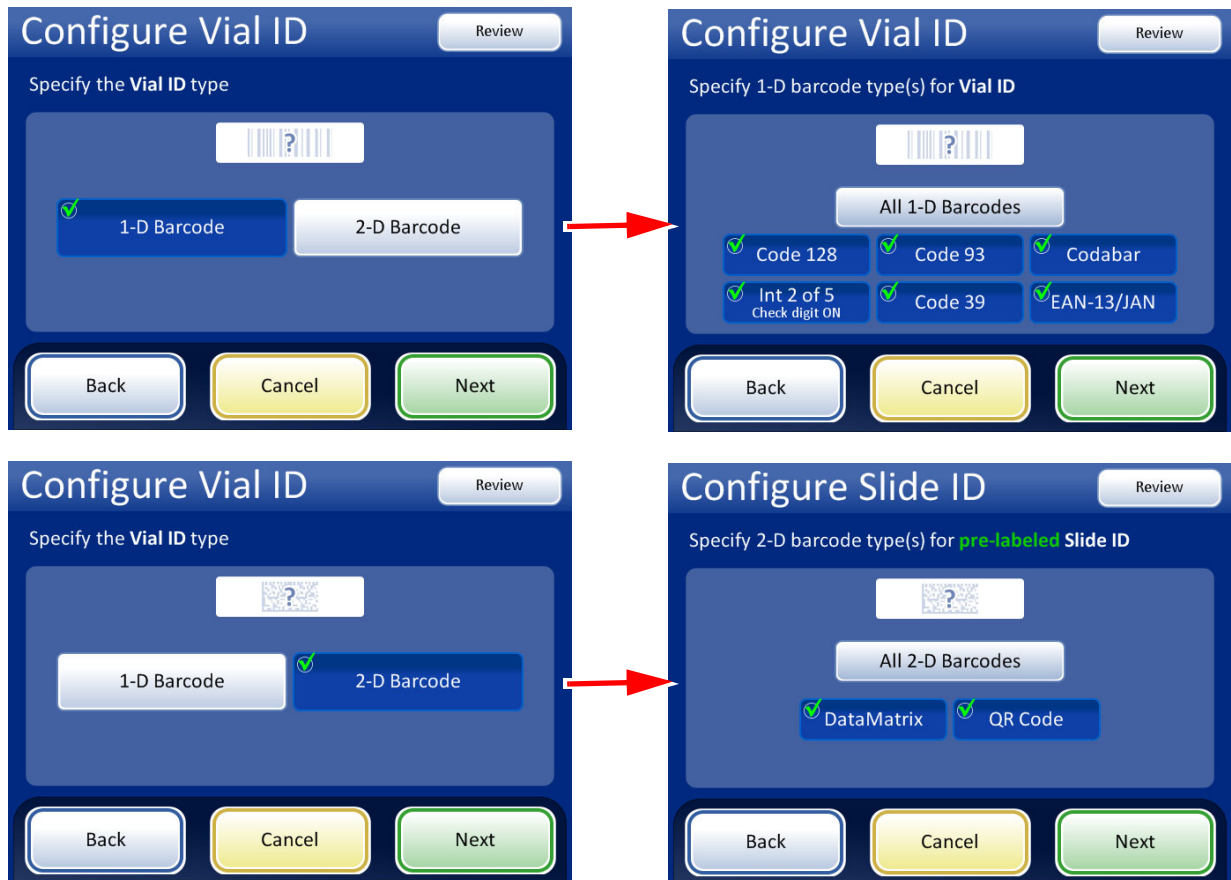

Figure 6-61 Configure Vial ID barcode type(s)

Note: For best performance, select only the barcode type(s) that are used for vial IDs in your laboratory, and do not select barcode types that are not used in your lab.

The ThinPrep 5000 processor can be set up to use the entire vial ID as the slide ID, or it can be set up to recognize a portion of the vial ID for use in the slide ID.

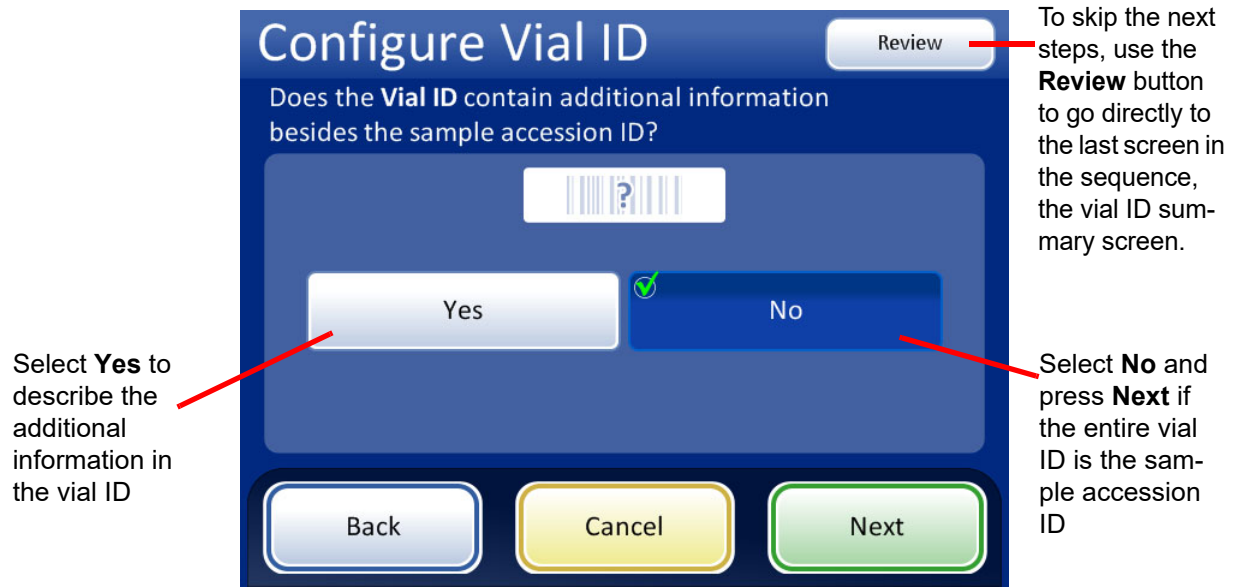

Figure 6-62 Additional information in the vial ID besides the sample accession ID

If the vial ID contains additional information besides the sample accession ID, configure the ThinPrep 5000 to recognize where the accession ID is within the vial ID. Also configure the instrument to recognize additional information in the vial ID as one or more section of the vial ID, taking into consideration how, or if, the additional information will appear on a slide label.

6

USER INTERFACE

Note: The accession ID in the vial ID is the portion of the vial ID that is used to configure the slide ID. See “Configure Barcodes” on page 6.42 for more information.

Each of the sections set-up in the Vial ID configuration, can be included in the label design for laser-etching slide IDs on the AutoLoader.

Touch the box to open the keypad

Total sections: 4

Separating character: |

Clear Cancel Save Changes

Touch the **Save Changes** button to save the information and move to the next screen.

To clear the Total sections and Separating character fields, touch **Clear**.

Figure 6-63 Vial information screen

Enter the total number of sections and a one-character separator. The total number of sections must be between two and four. For example, if a vial ID always starts with data that is not the accession ID, the ThinPrep 5000 processor with AutoLoader can be configured to consider the vial ID as two segments: “Field 1” and the accession ID.

Touch the box to the right of the text to open the keypad. Enter the number or character and press **Done** to return to the Vial Information screen. Press the **Save Changes** button to save and return to the Configure Vial ID screen. The Configure Vial ID screen now displays the number of sections. Touch the position of the section where the accession ID is. In this example, the vial ID starts with the accession ID and has three additional fields. In this example, the accession ID and the three additional fields are separated by a “|” (vertical line) character.

The screen display shows the number of sections and the position of the accession ID within the vial ID.

Press **Back** to return to the previous screen.

Press **Cancel** to cancel the vial ID configuration.

Press **Next** to go to the Vial ID summary screen.

Figure 6-64 Accession ID and additional information within the vial ID

6

USER INTERFACE

Review the summary of the vial ID configuration. To save the configuration, press **Save Changes**. To change a setting, use the **Back** button. To check that the vial ID configuration matches vial IDs in your laboratory, press the **Test Settings** button.

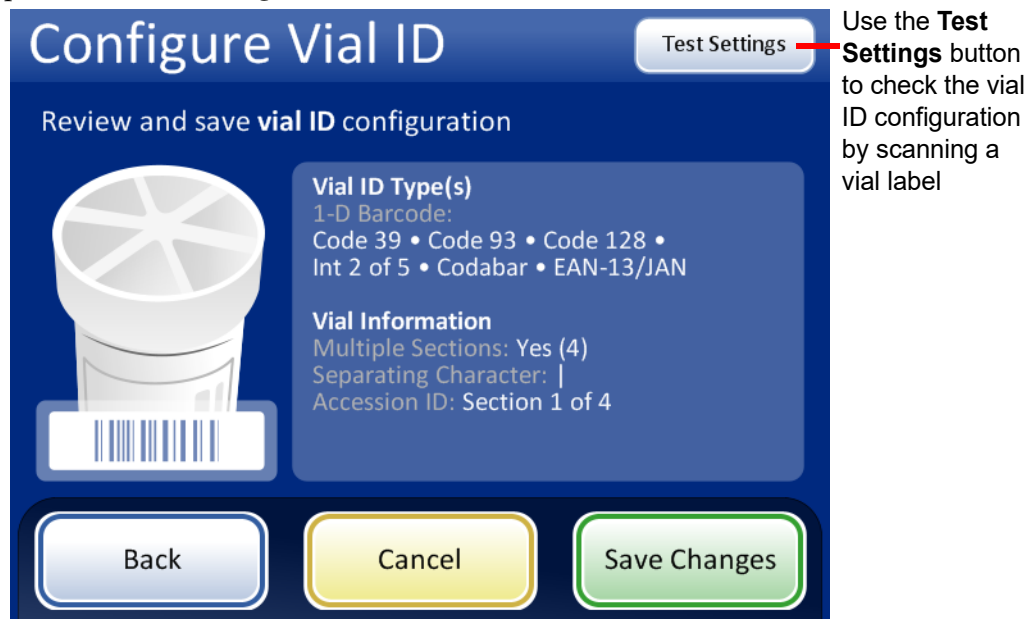
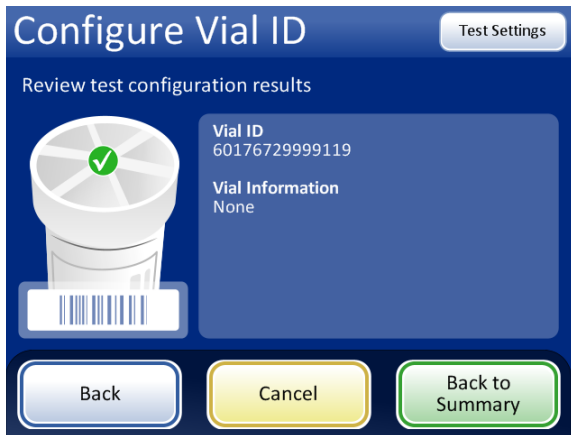
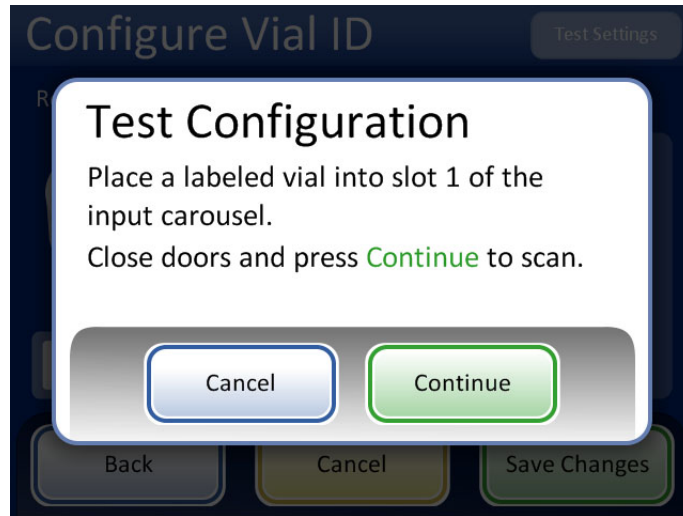

Figure 6-65 Configure vial ID summary screen

To test the vial ID configuration, use a labeled vial. Place the labeled vial into slot 1 of the input carousel. Close the doors and press **Continue** to scan.

The instrument removes the vial from slot 1 of the carousel and scans the vial ID to check that the scanned ID matches the vial ID barcode configuration set up on the instrument.



Successful Vial ID configuration. The vial ID configuration information matches the vial label that was scanned. In this example, the vial ID has an accession ID is “60” and there are two additional fields in the vial ID besides the accession ID. This configuration matches a vial printed with “60|7672999|9” on the vial label.

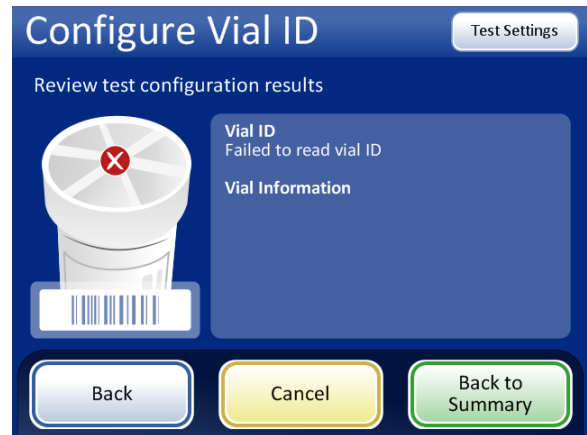

If the vial ID on the vial does not match the criteria configured for the vial ID, the screen display reports that the instrument failed to read the vial ID. Correct the vial ID on the label or correct the vial ID configuration before processing samples.

Figure 6-66 Test vial ID settings

6

USER INTERFACE

When the vial ID is properly configured, return to the summary screen and save the changes.

Configure Slide ID

Note: Particular components, available through Hologic Technical Support, are required to etch the EAN-13/JAN and Codabar 1-D barcode types and the QR Code 2-D barcode type.

The section of the vial ID identified as the accession ID in the Configure Vial ID setting is the portion of the vial ID that is used to configure the slide ID. It is referred to as “vial ID” in the Configure Slide ID settings.

The ThinPrep 5000 processor with AutoLoader can be configured to laser-etch the slide ID onto each slide, or it can be configured to process slides to which labels are applied prior to loading the slides into the slide carousel, for Small Batch mode. Configure the instrument for AutoLoader mode and for Small Batch mode. See Figure 6-67.

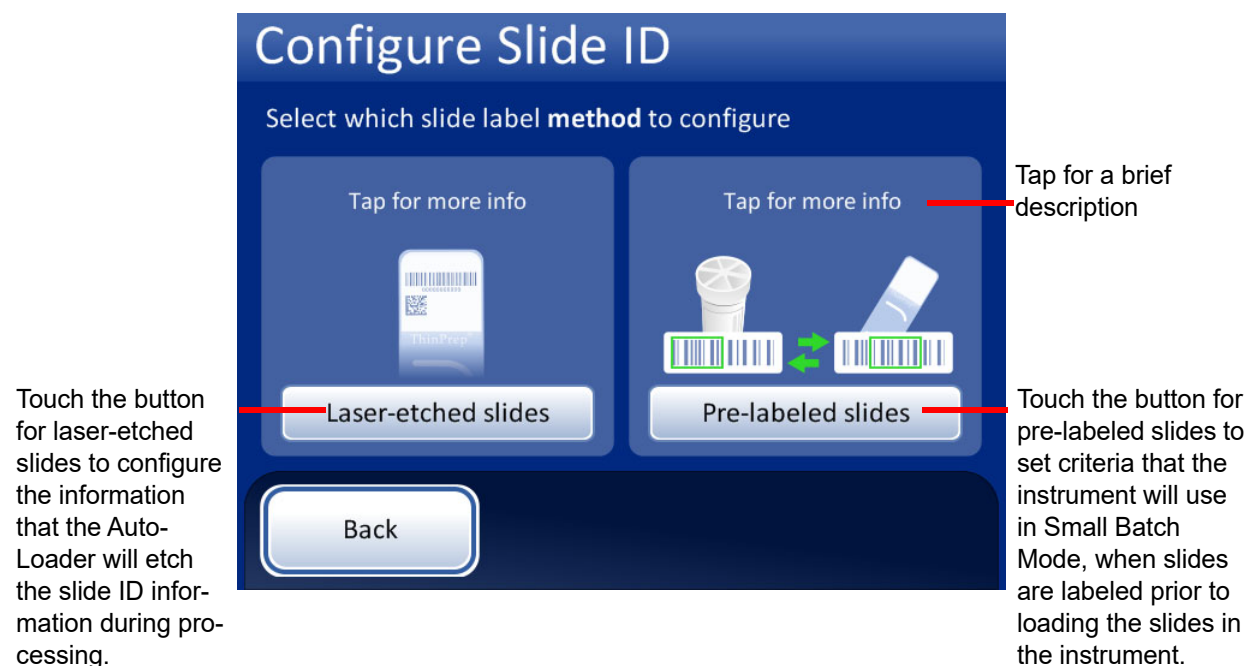

Figure 6-67 Select slide label method

Configure slide ID for laser-etched slides

The slide ID must be based on the vial ID. There are four options for configuring laser-etched slide IDs. Combinations of the four options can be used.

If more than one option is used, the options are applied in the following order:

1. Select a segment from the vial ID
2. Replace characters (in that segment, if any)
3. Insert characters (in the segment with the replaced characters, if any)
4. Append characters (to the segment, with the replaced and inserted characters, if any)

In addition to configuring the slide ID in the Configure Barcodes settings, the laser-etched label must be designed in the Design Label setting.

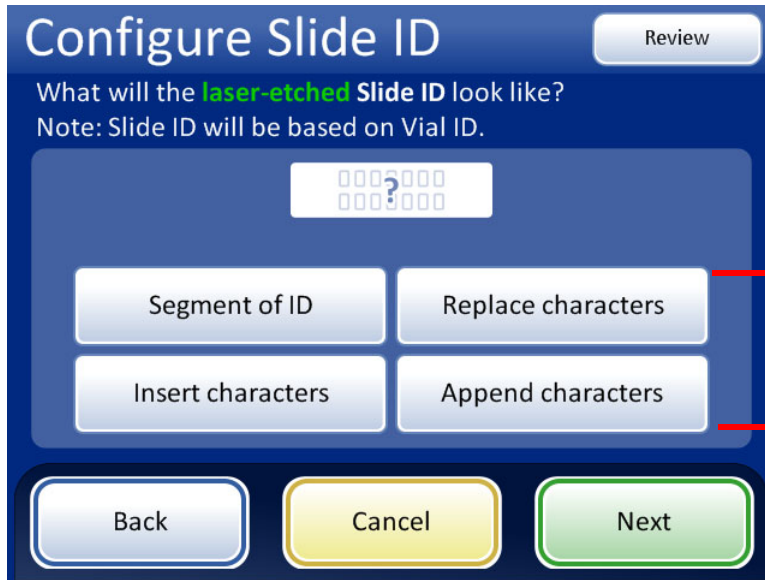

Select and set one or more of these options to describe the slide ID's relationship to the accession ID portion of the vial ID. If the slide ID and vial ID are identical, do not make a selection here.

Figure 6-68 What will the laser-etched Slide ID look like?

Segment of ID

The ThinPrep 5000 processor with Autoloader can be configured to etch slide IDs that are always the same segment of the vial IDs.

	Accession ID section of the vial label	Slide ID
Example	ABC1234DEF	1234

1. Touch the **Segment of ID** button.
2. Indicate where, in the vial ID, the segment that is used on the slide ID starts.
 - If the first character of the segment to use in the slide ID is the first character of the vial ID, leave the "Start at position" field blank.
 - If the starting point is a certain position in the vial ID, such as the fifth character, use the "Start at position" setting.
 - A. Touch the empty box to access the keypad.
 - B. Use the keypad to enter the number that represents the position of the character which is the start of the segment of the vial ID used in the slide ID, such as "5" for the fifth character.
 - If the starting point of the segment of the vial ID used in the slide ID is a certain character, touch the triangle next to "Start at position" to see the "Start at character" field.
 - C. Touch the name **Start at character** to select it.



USER INTERFACE

- D. Touch the empty box to access the keypad.
 - E. Use the keypad to enter the character that starts the segment of the vial ID used in the slide ID. This character is treated like a boundary, and this character is not included when the segment of the vial ID is used in other areas of the Configure Barcodes settings.
 - F. Press **Done** to close the keypad.
3. Indicate where, in the vial ID, the segment that is used on the slide ID ends.
If the end of the segment to use in the slide ID is the end of the vial ID, leave the “Segment length” field blank.
If the ending point of the segment of the vial ID used in the slide ID is always the same number of characters from the starting point of the segment, use the “Segment length” field.
- A. Touch the empty box to access the keypad.
 - B. Use the keypad to enter the character that ends the segment of the vial ID used in the slide ID.
If the ending point of the segment of the vial ID used in the slide ID is a certain character, touch the triangle next to “Segment length” to see the “End at character” field.
 - A. Touch the name **End at character** to select it.
 - B. Touch the empty box to access the keypad.
 - C. Use the keypad to enter the character that ends the segment of the vial ID used in the slide ID. This character is treated like a boundary, and this character is not included when the segment of the vial ID is used in other areas of the Configure Barcodes settings.
 - D. Press **Done** to close the keypad.
4. Press **Save Changes** to save the details.

Replace characters

The ThinPrep 5000 processor with Autoloader can be configured to etch slide IDs that are the vial IDs with certain characters replaced.

	Accession ID section of the vial label	Slide ID
Example	AB-CD-1234	AB-XY-1234

1. Touch the **Replace characters** button.
2. Touch the box next to the “Characters to replace” to access the keypad.
3. Use the keypad to enter the characters to replace in the vial ID.
4. Use the keypad to enter the characters that replace the vial ID characters in the slide ID.
5. Press **Done** to close the keypad.
6. Press **Save Changes** to save the replaced characters’ information.

Insert characters

The ThinPrep 5000 processor with Autoloader can be configured to etch slide IDs that are the vial IDs with certain characters added at the beginning of the slide ID.

	Accession ID section of the vial label	Slide ID
Example	12345	ABC12345

1. Touch the **Insert characters** button.
2. Touch the box next to “Starting characters” to access the keypad.
3. Use the keypad to enter the character or characters that are always at the start of the slide ID.
4. Press **Done** to close the keypad.
5. Press **Save Changes** to save the starting or inserted characters’ information.

Append characters

The ThinPrep 5000 processor with Autoloader can be configured to etch slide IDs that are the vial IDs with certain characters added at the end of the slide ID.

	Accession ID section of the vial label	Slide ID
Example	12345	12345ABC

1. Touch the **Append characters** button.
2. Touch the box next to “Ending characters” to access the keypad.
3. Use the keypad to enter the character or characters that are always at the end of the slide ID.
4. Press **Done** to close the keypad.
5. Press **Save Changes** to save the ending or appended characters’ information.

6

USER INTERFACE

The screen display shows a summary of the Slide ID custom settings.



Figure 6-69 Configure laser-etched slide ID - summary screen

Review the summary of the slide ID configuration. To save the configuration, press **Save Changes**. To change a setting, use the **Back** button.

The OCR and 1-D barcode types often require shorter slide IDs than 2-D barcode types. If the barcode configuration settings for the slide ID are likely to create a slide ID that is too long for the barcode type to be laser-etched on the slide, a yellow caution sign is displayed in the summary screen. Touch the yellow triangle on the screen display to see the message.

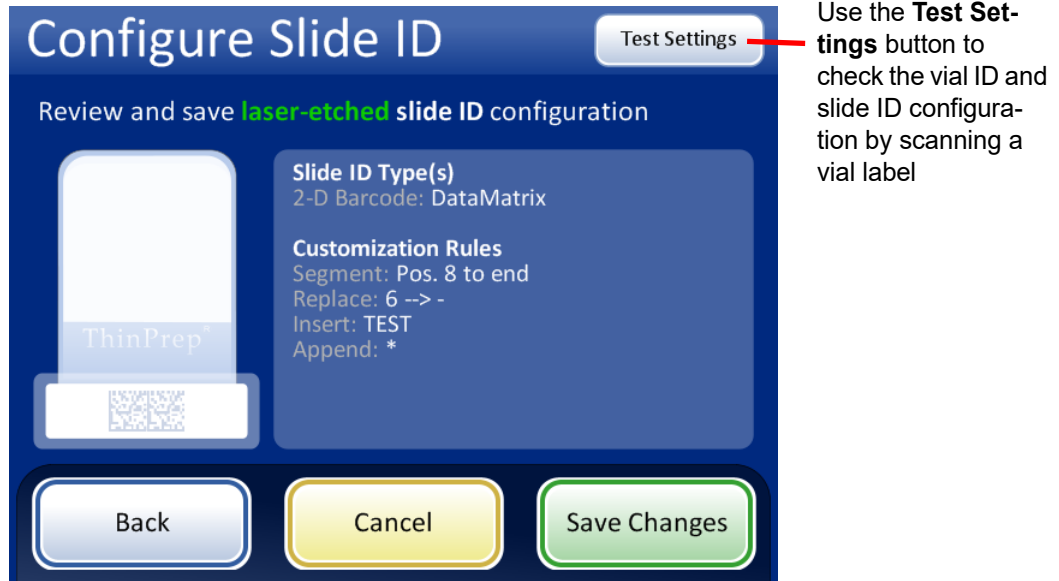

Figure 6-70 Summary screen for configuring laser-etched slides

To test the slide ID configuration, use a labeled vial. Place the labeled vial into slot 1 of the input carousel. Close the doors and press **Continue** to scan.

The instrument moves the vial in slot 1 of the carousel and scans the vial ID. The test not only checks that the vial ID scanned matches the vial ID configured, but the screen display also shows a preview of the information that will be etched onto slides, including the accession ID and any additional slide configuration information.

6

USER INTERFACE

The screen display shows the vial ID that was scanned and it shows the custom slide ID, which is the accession ID portion from the vial customized by using a chosen segment, and/or with characters replaced, inserted or appended.

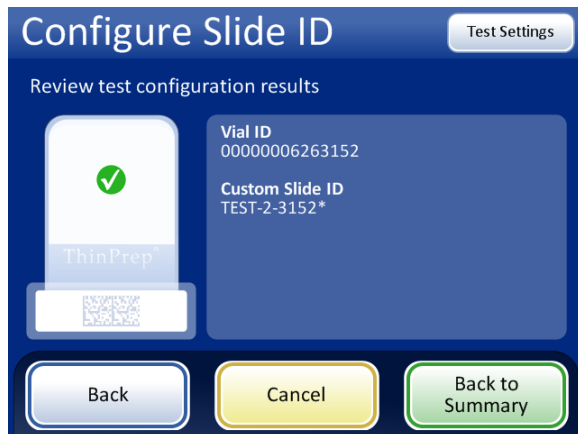
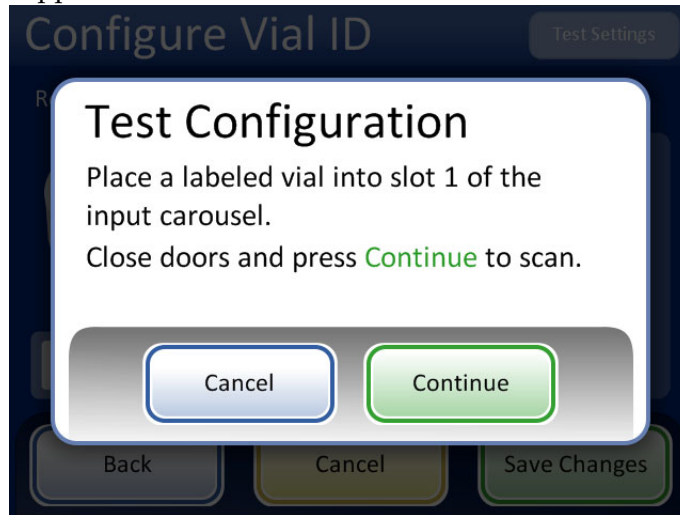

Successful Slide ID configuration. The vial ID configuration information matches the vial label that was scanned. The slide ID for the sample in this vial would be etched as “TEST-2-3152*”, in this example, (corresponding to the laser-etched slide configuration settings shown in Figure 6-69.)

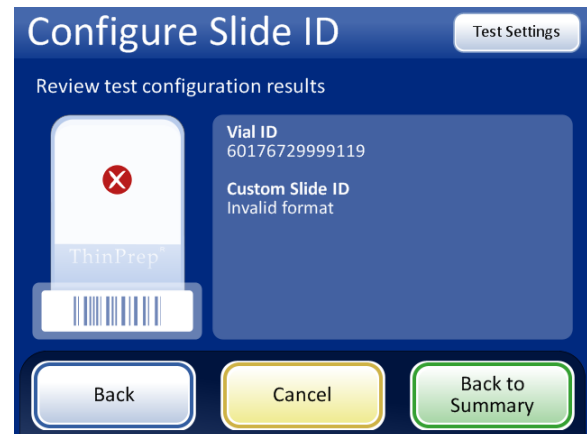

If the configuration settings for the slide ID cannot be combined to produce a valid slide ID for the slide design, a red “x” appears in the test configuration results. Correct the slide ID configuration settings before processing samples.

Figure 6-71 Test slide ID settings

When the slide ID is properly configured, return to the summary screen and save the changes.

Configure slide ID for pre-labeled slides

For Small Batch mode when the slides are already labeled prior to loading the ThinPrep 5000 processor, configure the type of barcode(s) used on the slide labels so that the ThinPrep 5000 processor recognizes the vial ID and slide ID from other information that may be printed on the labels. A barcode or OCR format must be used for the slide ID.

Touch the ID type to select it: 1-D Barcode, 2-D Barcode, OCR: Imager, or OCR: Non-Imager.



Figure 6-72 Specify the pre-labeled Slide ID type

Press **Next** to continue.

6

USER INTERFACE

For 1-D barcodes, touch an ID type to select it.

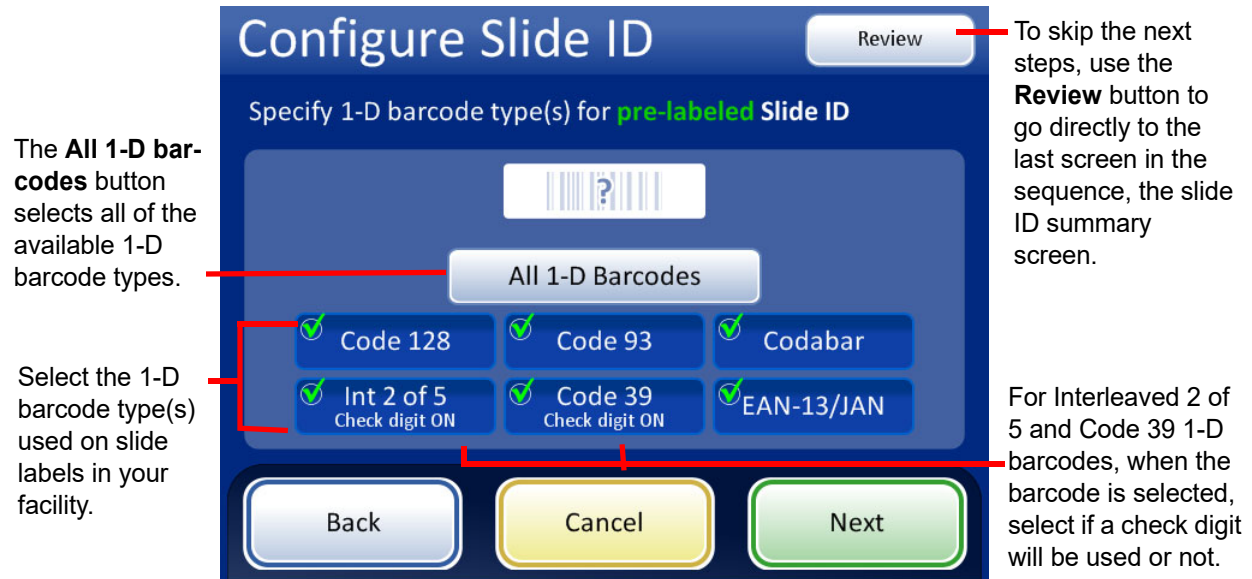

Figure 6-73 Specify the 1-D barcode type(s) for pre-labeled Slide IDs

Press **Next** to continue.

For 2-D barcodes, touch an ID type to select it.



Figure 6-74 Specify 2-D barcode type(s) for pre-labeled Slide IDs

Press **Next** to continue.

The slide ID and the vial ID can be identical, or they can differ. The slide ID and the vial ID must share a unique portion of their IDs. Specify whether they are identical or where the slide ID and vial ID differ so that the ThinPrep 5000 processor recognizes a match between the vial ID and slide ID

6

USER INTERFACE

and distinguishes the vial ID and slide ID from other information that may be printed on the vial label and/or slide label.

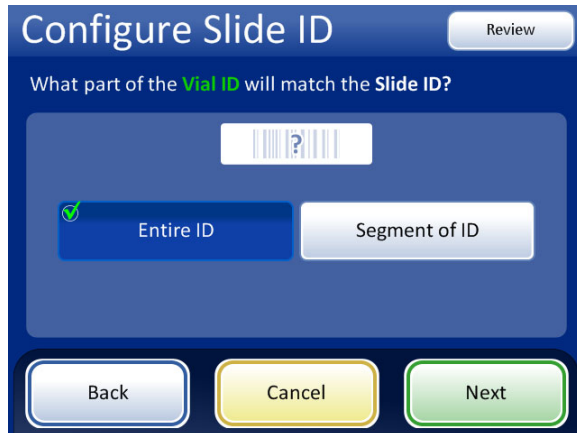

If all of the vial's accession ID (vial ID) is used in the slide ID, select **Entire ID**.

If only a segment of the vial's accession ID (vial ID) is part of the slide ID, select **Segment of ID** and then specify where that segment starts and finishes.

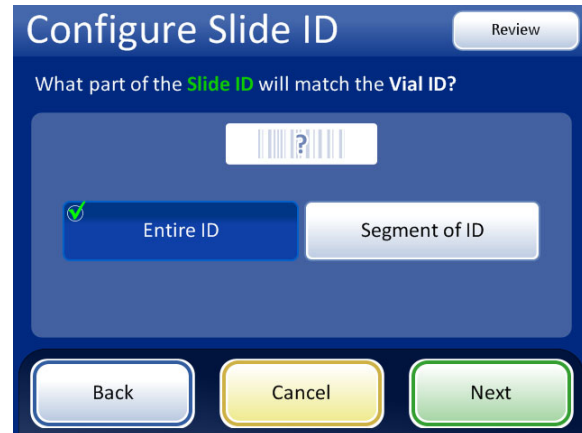

If all of the slide ID matches the vial's accession ID (vial ID), select **Entire ID**.

If only a segment of the slide ID is the vial's accession ID (vial ID), select **Segment of ID** and then specify where that segment starts and finishes.

Figure 6-75 Pre-labeled Slides - matching between Vial ID and Slide ID

If the vial ID contains additional information that is not part of the slide ID, indicate how to identify the segment of the *vial ID* to use for matching vial IDs and slide IDs.

If the slide ID contains additional information that is not part of the vial ID, indicate how to identify the segment of the *slide ID* to use for matching the vial IDs and slide IDs.

The steps for configuring the instrument to recognize a segment of the vial ID and the slide ID with pre-printed labels are the same as steps 2 through 4, used for configuring laser-etched slide IDs. Refer to "Segment of ID" on page 6.51.

The Configure Slide ID screen shows a summary of the pre-labeled Slide ID setting. To test that the settings for the pre-labeled slide ID configuration are correct for your facility, press the **Test Settings** button.

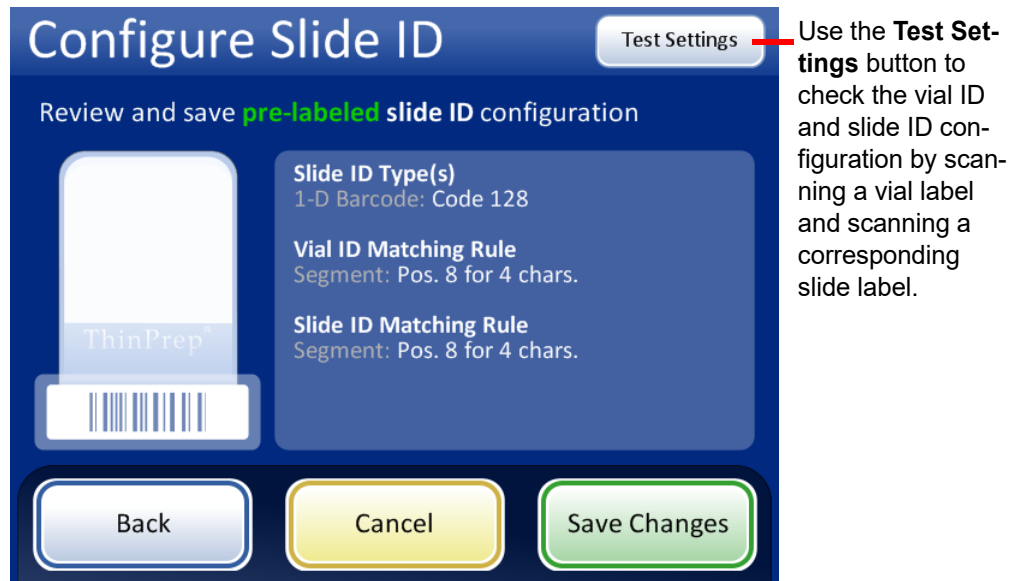

Figure 6-76 Configure slide ID for pre-labeled slided - summary screen

To test the pre-labeled slide ID configuration, use a labeled vial and the labeled slide that goes with it. Place the labeled vial and slide into slot 1 of the input carousel. Close the doors and press **Continue** to scan.

The instrument moves the vial in slot 1 of the carousel and scans the vial ID. The instrument removes the slide from slot 1 of the carousel and scans the slide ID. The test checks that the vial ID scanned matches the vial ID configured, that the vial ID scanned matches the slide ID scanned, and that the slide ID scanned matches the slide ID configured on the instrument.

For pre-printed slide labels, the test of the configuration generates two pieces of information for the vial ID and two for the slide ID.

- Vial ID - The entire accession ID from the vial is shown, and the segment of that vial ID that matches the slide ID is shown as the “Formatted ID”.
- Slide ID - The entire accession ID in the slide ID is shown, and the segment of the slide ID that matches the vial ID is shown as the “Formatted ID”.
- Chain of Custody - This checks that the formatted ID segments of the vial ID and slide ID match.

6

USER INTERFACE

The screen display shows the vial ID that was scanned, the slide ID that was scanned and the section of the vial ID and slide ID that match.



Successful slide ID configuration for pre-printed slides. The vial ID and the slide ID in this example have the segment “9999” in common, which can be configured as the segment starting after the eighth position and ending after 4 characters.

If the vial ID and/or slide ID do not match their configuration settings, or if the specified segment of the slide ID and vial ID do not match, a red “x” appears in the test configuration results. Correct the vial ID and/or slide ID configuration settings before processing samples.

Figure 6-77 Test pre-printed slide ID settings

When the slide ID is properly configured, return to the summary screen and save the changes.

Change Air Filter

This is described in Chapter 8, Maintenance.

Clean System

This is described in Chapter 8, Maintenance.

SECTION E

REPORTS AND LOGS



Figure 6-78 Reports and Logs Button

The Reports and Logs interface presents system information in five forms:

- **System Events** - a log of all system errors excluding UPS power status events or sample preparation errors that do not interfere with the operation of the instrument. The record of errors is retained for three years; errors older than three years are purged.
- **Batch Reports** - displays the success or failure of sample processing for each vial tray processed.
- **Usage Details** - indicates the number of slides successfully created to date, by sequence type.
- **Carousel Report** - displays the status of sample errors resulting in vial or slides left in the carousel at the end of a batch.
- **Vial Event Report** - displays a detailed list of all sample processing errors that occurred in the most recent batch.

6

USER INTERFACE

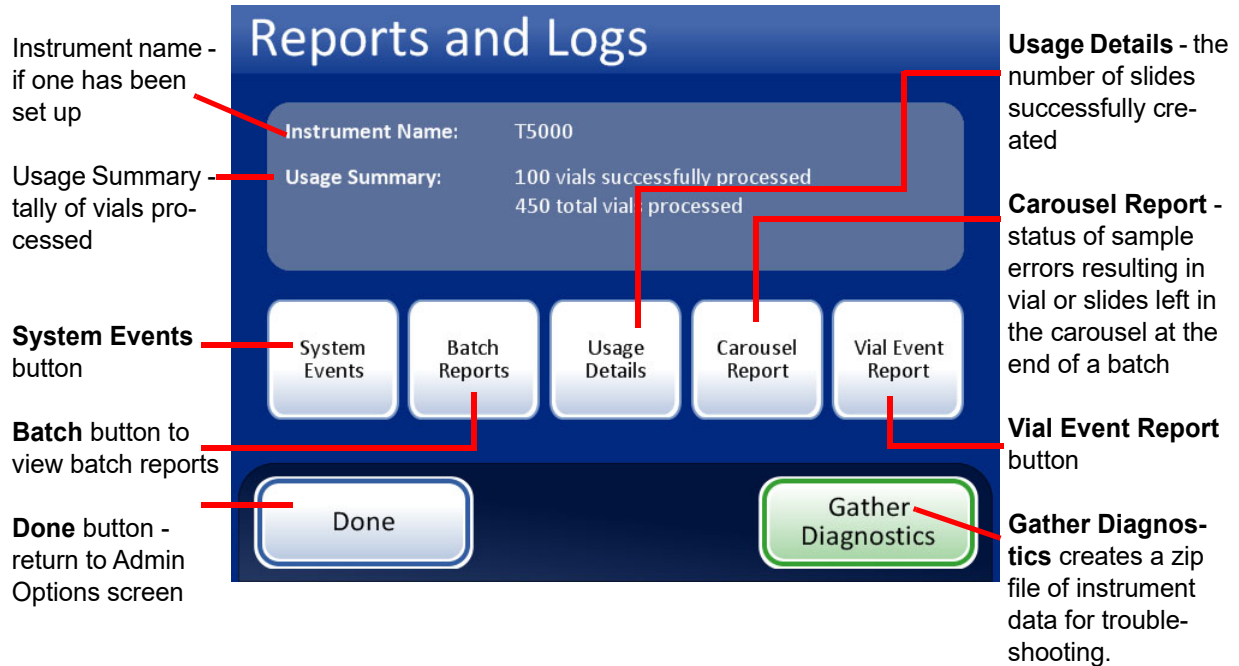

Figure 6-79 Reports and Logs Screen

System Events



Figure 6-80 System Events Button

The System Events screen displays all of the error conditions encountered during sample processing. A system event is an error condition that the instrument is not capable of recovering from without user intervention.



Figure 6-81 System Events Screen

The list of system events includes the event code, the date and time of the error and the usage count - a tally of all samples processed on the instrument at the time of the event.

The **Event Codes** button displays a list of error codes that occurred for that batch. (Refer to Chapter 9, Troubleshooting for detailed explanations of error codes.) Figure 6-82 shows an error codes list.



Figure 6-82 Event Codes Screen



Batch Reports



Figure 6-83 Batch Reports Button

The system creates an individual batch report for each tray processed from the AutoLoader. A display will show a list of the reports generated for the last eight weeks, with the most recent at the top of the list. Each individual report is titled by a date and time stamp, generated at the moment the batch completed. See Figure 6-84.



Figure 6-84 Batch Reports List

Touch a report field to select it. The report is displayed on the user interface. See Figure 6-85.



Figure 6-85 A Batch Report Display

A Batch Report is generated every time slides are processed. An AutoLoader batch is 1–40 samples in a vial tray. See Figure 6-85 and Figure 6-86.

The header of every printed batch report identifies every batch with:

- Date/time stamp, which records the time the batch started and ended
- The names of the lab and the processor (if this is set up in the Settings tab, page 6.26)
- The serial number of the ThinPrep 5000 processor with AutoLoader
- The type of process sequence selected for the batch to run
- The status of the batch: OK or an error code number which corresponds to a system error that ended the batch or operator cancellation of the batch

The batch report lists every vial encountered by the system and for each vial, lists:

- The vial tray position it was in
- The vial ID read off of the vial label
- The slide ID read off of the slide label
- Any sample errors that may have occurred, with the event code
- Vials processed



USER INTERFACE

Batch report header with identifying information and batch status

List of sample errors (no slide was made)

ThinPrep® 5000 Batch Report

Start Time: 10/21/2010 10:15 AM
End Time: 10/21/2010 11:45 AM
Lab: Hologic
Instrument: T5000
Serial number: D002K09DP
Sequence: Gyn
Status: OK

2 Sample Errors

Tray-Pos.	Carousel Pos.	Vial/Slide ID	Status	Description
1-2	2	8366890999150	5010	Insufficient fluid or no filter present
1-8	1	79000781178110	5002	Failed to uncap vial

38 Vials Processed: 33 OK 5 Events

Tray-Pos.	Vial/Slide ID	Status	Description
1-1	83668809999025	OK	-
1-3	79000151115002	5000	Sample is dilute
1-4	08387390999138	OK	-
1-5	83805969999060	5000	Sample is dilute
1-6	10019939999083	5000	Sample is dilute
1-7	10019979999206	OK	-

List of vials processed and any events (Slide was made but needs operator attention.)

Figure 6-86 Batch Report Example

To print a report, press the **Print** button (if your processor is configured with a printer).

To save a report as a text file, press the **Save to USB** button. See the next section.

To close a report, press the **Done** button.

Note: The system will retain batch reports for eight weeks and then purge them from the database. Should your lab require longer record retention, plan to print or download the batch reports.

Find vial by ID



Figure 6-87 Find Vial by ID Button

The Batch Report list screen has a feature that enables searching for a vial ID using all or some of the accession number. Press the **Find Vial by ID** button.

The same keypad/keyboard screen that is used for entering lab name/instrument name is displayed. Type in all or some of the ID that is being searched for.



Keypad and keyboard display

Type in numbers or letters

Delete to remove entries

abc/123 to switch between keypad and keyboard

Cancel to return to Batches screen

Continue to search for the ID

Figure 6-88 Enter Full or Partial Vial ID

Press the **Continue** button to search all batch reports for the ID. The report with that ID will be listed, or a list of reports if a partial ID was entered. See Figure 6-89.

6

USER INTERFACE

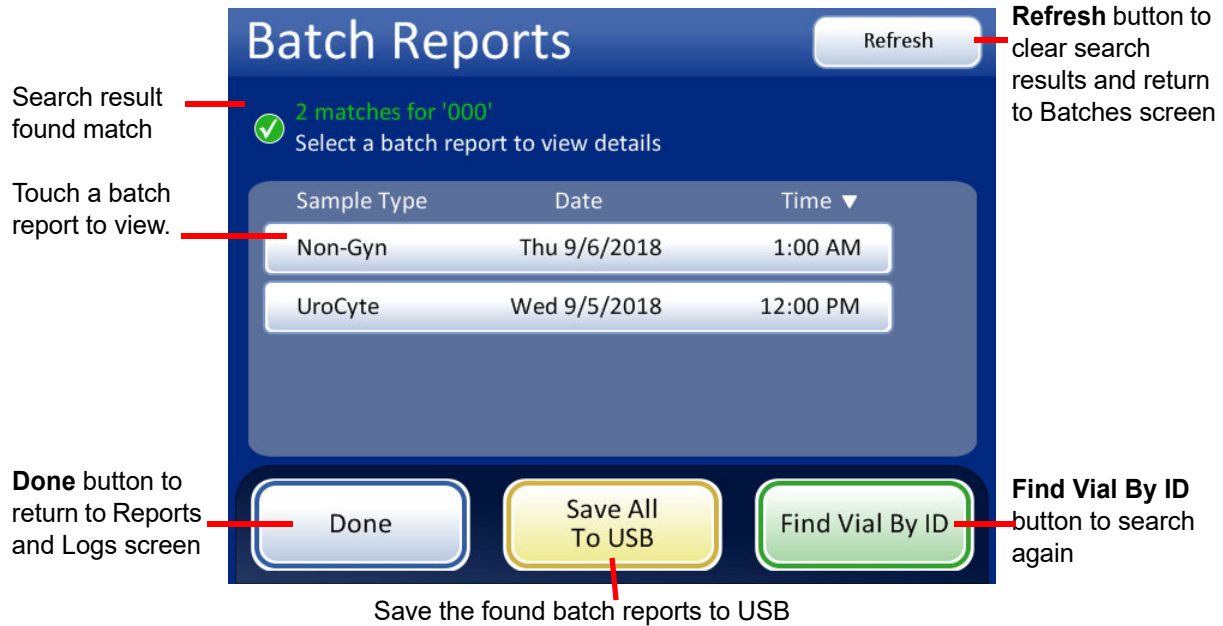

Figure 6-89 Find Vial ID Search Results Screen

If a match or matches are found in the batch reports for value searched for, the batch report is listed on the display. Touch a report to open it. The item(s) with the search value appear highlighted in green.



Figure 6-90 Vial ID Search Results

Note: Batch reports are stored in the system database for eight weeks and purged as new ones are generated. If your configuration includes the optional LIS interface, reports are *also* stored indefinitely on the NAS until your system administrator purges them.

Save a report to USB key

See Figure 2-3 for USB port locations.

Reports can be saved to a USB key (also known as a thumb drive, flash drive, keychain drive). Insert a key into any of the USB ports.

CAUTION: Always use the USB drive provided with the processor. Never use a U3 Smart Drive. While the system is able to write to this device, there is a significant problem if the system is booted with one of these drives inserted in a port. Field service would be required. Note also that the system cannot write data to a write-protected USB key.

When the **Save to USB** button is pressed, the report that is open on the user interface is immediately saved to the USB device as an XML file. A confirmation message displays on the interface. See Figure 6-91.

Note: If the system detects that more than one USB port has a USB key inserted, a message via the user interface will prompt you to select which port to send the report to.

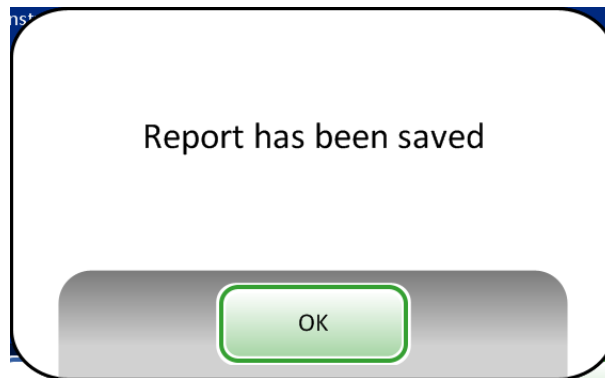

Figure 6-91 The Report Has Been Saved Message

The system creates a folder titled T5000Reports on the USB device. Each report is written to there. Reports are automatically named by the convention of "Report type - Processor Name - Date and Time. XML." This is illustrated below. With each report type, a style sheet file is also created, so that when the report is viewed or printed from any other source, it will look like the report seen on the T5000 interface.

6

USER INTERFACE

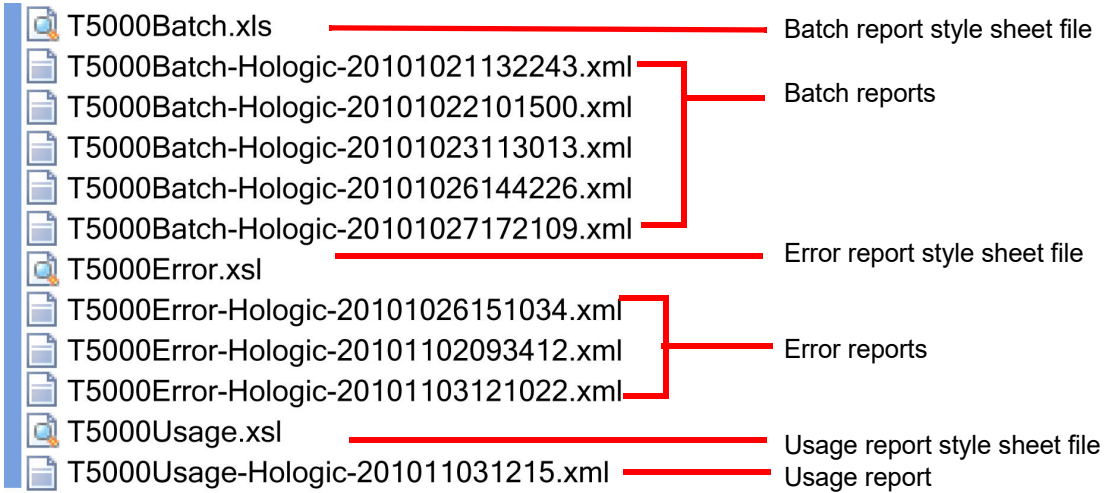

Figure 6-92 Reports Saved to USB

Usage Details



Figure 6-93 Usage Details Button

The Usage Details screen displays the following information:

- Instrument name:** Instrument: T5000
- Date:** 9/17/2018
- Sequence types table:**

Sequence	Success	Total
Gyn	80	150
Non-Gyn	15	150
UroCyte	5	150
Total	100	450

At the bottom of the screen are three buttons: "Done", "Save to USB", and "Print".

Figure 6-94 Usage Details Screen

The usage details report keeps a tally of the number of slides created to date on the ThinPrep 5000 processor with AutoLoader.

The usage history report header identifies:

- The date and time of the report
- The lab name (if one is used)
- The processor name (if one is used)

The usage history report identifies:

The number of slides successfully processed, Gyn (includes Imager slides), Non-Gyn and UroCyte.



Note: A sample vial that is picked up, uncapped and placed into the dispersion well increments the Total samples run counter. A slide deposited into the fixative bath increments the Successful samples run counter.

Carousel Report



Figure 6-95 Carousel Report Button

At the conclusion of processing, there may be vials, filters and slides left in the carousel. The carousel report details what is left in the carousel and its status.

- Usually this is due to **sample error** and the vial that did not process successfully is left in the carousel for operator resolution.
- Occasionally a **system error** may halt processing and any media that was in transit through the processing path is placed in the carousel.

Only the most recent carousel report exists at any time. Each new carousel report that is generated replaces the current one.

Note: If a carousel of samples is run using Small Batch Mode, a batch report is generated at the conclusion of the run. It is located on the Batch Reports screen. Carousel Reports are only generated when using the AutoLoader.

Refer to Carousel Report, Figure 6-96. The Carousel Report has a summary section, carousel position details section and a position status map.

Vial and slide status

Error Hold - that vial has a sample processing error. and it was not returned to the vial tray. A slide has been etched, but no cells applied. It is in the carousel with the vial. See the details section to resolve the error.

Waiting Return - the vial was processed successfully, and a slide was processed and deposited into the bath. A system error condition prevented the vial from being returned to the vial tray.

Unprocessed - A system error was encountered, and the vial was not processed. A slide has been etched, but no cells applied. The slide is in the carousel with the vial. See the details section to resolve the error.

Note: If the operator aborted processing by pressing **Pause** and then selecting **End Immediately** (see "Pause a Batch" on page 6.19) media will be left in the carousel, rather than being put away. The operator must see to the disposition of these vials and slides.

ThinPrep® 5000 Carousel Report

Start Time: 10/21/2010 10:15 AM
 End Time: 10/21/2010 11:45 AM
 Lab: Hologic
 Instrument: T5000
 Serial number: D002K09DP
 Autoloader Serial Number: D004M10DA

Report header contains date/time stamp and instrument identification.

Carousel Report Summary

Pos.	Vial	Filter	Slide	Tray-Pos.	Vial Status
1	Yes	No	Yes	1-1	Error Hold
2	No	No	No	-	-
3	Yes	Yes	No	1-14	Unprocessed
4	Yes	Yes	Yes	2-16	Error Hold
5	Yes	No	No	2-21	Unprocessed
6	No	Yes	No	-	-
7	Yes	No	Yes	3-4	Waiting Return
8	Yes	No	Yes	4-13	Waiting Return
9	No	No	No	-	-
10	Yes	Yes	Yes	4-40	-
11	No	No	No	-	-
12	No	No	No	-	-
13	No	No	No	-	-
14	No	No	No	-	-
15	No	No	No	-	-
16	No	No	No	-	-
17	No	No	No	-	-
18	No	No	No	-	-
19	No	No	No	-	-
20	No	No	Yes	-	-

Carousel Report Summary - indicates the presence of media in each position where the vial was originally located (vial tray-position) a brief vial status

Carousel Position 1 Details:

Vial Present:	Yes	Vial Status:	Error Hold
Filter Present:	No	Vial ID:	74041829999
Slide Present:	Yes	Slide ID:	74041829999
Tray-Pos:	1-1	Slide Type:	Gyn
Vial Type:	Gyn		
Status Details:	5010 - Insufficient fluid or no filter present		

Carousel Position Details indicate:

- Media present
- Error type
- Accession ID and slide type

Carousel Position Status Map

Position Status																			
1	2	3	4	5	6	7	8	9	10	11	12	13	14	15	16	17	18	19	20

Carousel Position Status Map provides a quick visual overview of where material is present in the carousel.

NOTE: Empty Position = X

Figure 6-96 Carousel Report



Vial Event Report



A Vial Event Report is generated every time vials are processed. The vial events report identifies the position of a vial when an error occurs during processing. A vial event report only lists a vial tray if that vial tray has a processing error. The vial events report indicates whether or not a slide was made. The vial events report retains data for a vial until the vial tray is removed and replaced in the AutoLoader.

Vial information:
Starting position in tray
Current location of the vial

Slide information:
Current location of the slide
Slide Made:
Yes if sample was processed onto the slide;
No if the sample was not processed onto the slide.

Go To Baths to view the Baths' screen

Select an entry and press **Show Details** to see Vial Event Details for an entry

Status:
This lists the code for the vial event. Touch the code for information about the vial event.

Vial Events
Instrument: T5000 Date: 3/8/2019

Tray-Pos.	Vial	Slide	Slide Made	Status
1-10	Tray		No	5003
2-20	Tray	Bath	Yes	5016
3-30	Carousel (2)	Carousel (2)	No	5002
4-40	Removed	Removed	Yes	5001

Buttons: Done, Save to USB, Print

Done button to return to the Reports and Logs screen

Save to USB or **Print** (if enabled)

Figure 6-97 Vial Events Report

The Vial Event Details screens shows the Vial ID, Slide ID, and the Sample Type for the sample. See Figure 6-98.



Figure 6-98 Vial Event Details

Gather Diagnostics



Figure 6-99 Gather Diagnostics Button

Gather Diagnostics is a function intended for instrument troubleshooting by Hologic Technical Support. It gathers and zips the error history log and other instrument operating information. The zip file contents are password-protected.

Put a USB device into one of the USB ports and press the **Gather Diagnostics** button.

6

USER INTERFACE

Select the **Full** or **Quick** option, based on the instructions from Hologic Technical Support.

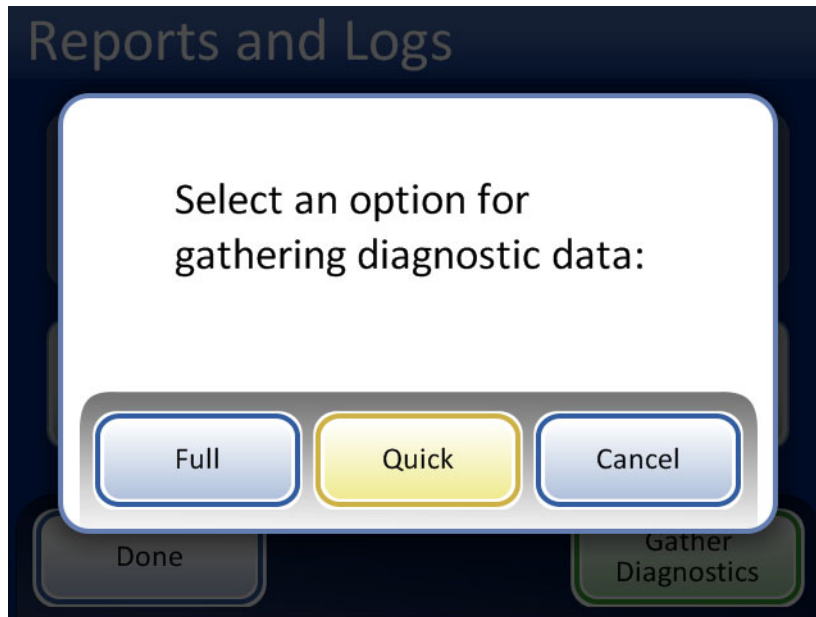

Figure 6-100 Select the Option for Gathering Diagnostic Data



Figure 6-101 Gather Diagnostics Screen

The instrument operating information will be gathered into a folder on the USB device titled T5000Logs. There will be three zipped files in the folder. These can be e-mailed to Hologic Technical Support.



USER INTERFACE

This page intentionally left blank.

Chapter Seven

Operating Instructions

SECTION A

INTRODUCTION

Normal instrument operation consists of loading supplies, starting the batch and unloading the prepared slides and processed sample vials when the batch is complete. A batch report is generated at the completion of each batch. The report indicates the success or failure of processing each vial, as well as any errors encountered. The report may be viewed on the user interface or a hard copy may be printed out, or the report may be saved as a text file to a USB key.

SECTION B

MATERIAL REQUIREMENTS

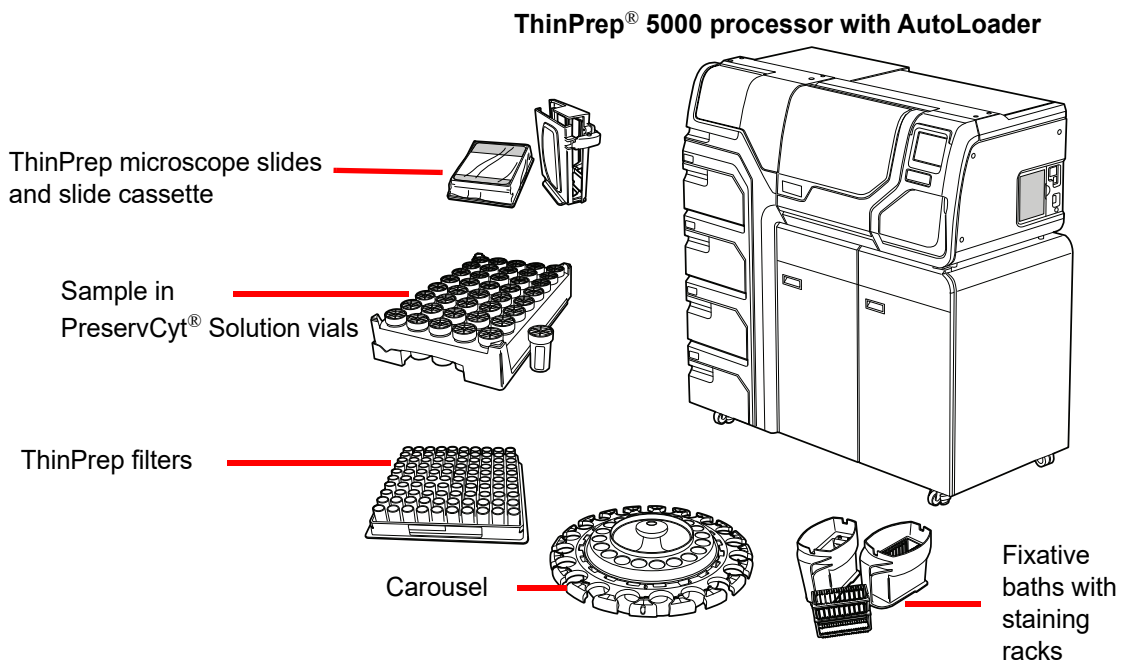

Figure 7-1 Required Materials



OPERATING INSTRUCTIONS

ThinPrep® **PreservCyt Solution** vial is a plastic vial that contains a methanol-based preservative solution that preserves cells from all body sites. PreservCyt Solution is used for transportation, storage and processing of cellular sample.

- Store PreservCyt Solution with gynecologic sample intended for ThinPrep Pap testing between 15°C (59°F) and 30°C (86°F) for up to 6 weeks.
- Store PreservCyt Solution with non-gynecologic samples intended for cytology between 4°C (39°F) and 37°C (98°F) for up to 3 weeks.

Refer to Chapter 3 for detailed information on PreservCyt Solution.

The **ThinPrep filter** is a disposable, plastic cylinder that is open at one end and has a filter membrane bonded onto the other end. The filter membrane has a flat, smooth, porous surface. The pore size differs, depending on the process application, thus there are three filter types for use on the ThinPrep 5000 processor:

- ThinPrep Pap test filters (clear)
- ThinPrep Non-gynecologic filters (blue)
- ThinPrep UroCyt filters (yellow)

The **ThinPrep microscope slide** is a high-quality, pre-cleaned, glass microscope slide with a defined screening area and a large labeling area. The slide is designed specifically for use with the ThinPrep 5000 processor with AutoLoader and depending on the process application there are three types of slides:

- ThinPrep microscope slides for use with ThinPrep processors are for gynecologic or non-gynecologic sample processing.
- ThinPrep Imaging System microscope slides for gynecologic slides that will be subsequently imaged on the ThinPrep Imaging System. (They bear pre-printed fiducial marks required for the Imaging System.)
- ThinPrep UroCyt microscope slides for use with the ThinPrep UroCyt urine sample processing. (The slides bear a particularly defined cell spot area for the processing of urine specimens.)

The **carousel** is a plastic tray that holds up to twenty sets of vials, filters and slides. It acts as a staging area for processing samples with the AutoLoader. It functions as the consumables input device when the instrument is being used in small batch mode.

The **alcohol fixative bath** is a plastic tub that is filled with standard laboratory fixative alcohol (95% reagent alcohol or 95% ethyl alcohol). The bath holds a staining rack, into which the processed slides are automatically deposited.

The **staining rack** is a standard staining rack used for collection and staining of cytologic slides.

The **ThinPrep 5000 Processor with AutoLoader Operator's Manual** contains detailed information about the operation, troubleshooting and maintenance of the processor. It also contains information on the solutions and materials required to prepare slides with the ThinPrep 5000 processor with AutoLoader.

Disposable laboratory gloves — Wear protective clothing in accordance with universal precautions when operating the instrument.

SECTION

C

LABELING THE SAMPLE VIALS

The ThinPrep 5000 processor with AutoLoader reads the sample vial ID labels and etches the ID onto the frosted area of the microscope slides. A slide scanner then reads the slide label and verifies they match. The slide scanner can read either barcode or OCR formatted labels. The operator configures the format etched onto the slide. Refer to “Configure Barcodes” on page 6.42 and “Design Labels” on page 6.36.

Vial Barcode Label Format

The sample vial barcode label must meet ANSI X3.182 specifications with a quality of grade B or better. Hologic recommends using Code 128, 1-D barcode symbology for the barcode label on the sample vial.

Refer to Table 6.2 on page 6.48 for detailed description of constraints placed on the ID depending on the slide format used. The constraints apply to slide IDs for pre-labeled slides and slide IDs etched by the AutoLoader.

The ThinPrep 5000 processor with AutoLoader also supports Interleaved 2 of 5, Code 39, Code 93, Codabar (NW7), and EAN-13 /JAN 1-D barcode symbologies.

The ThinPrep 5000 processor with AutoLoader also supports QR Code and DataMatrix 2-D barcode symbologies.

No OCR vial label formats may be used.

The ThinPrep 5000 processor with AutoLoader can use the barcode information on the sample vial label to etch the barcode onto the slide label.

For vial labels with a 2-D Data Matrix ECC 200 symbology, the minimum module width is 15 mil. The barcode should have a quiet zone around all four sides of at least one module width. The ThinPrep 5000 processor supports a vial ID of 5 to 64 characters. All printable ASCII 128 characters are supported.

Some ThinPrep vials come from Hologic with 2-D barcodes printed on the vial label. The ThinPrep 5000 processor recognizes that these are not barcodes for vial IDs.

There are two 16-digit numbering schemes that the ThinPrep 5000 processor will not recognize as a vial ID. If your laboratory uses a 16-digit vial ID format, do not use a vial ID in the format 10XXXXXX17XXXXXX, nor the format 01154200455XXXXX.

Use a square 2-D barcode that prints no larger than 9.53 mm (0.375 in.) x 9.53 mm (0.375 in.). This barcode must be printed clearly, not blurry or smudged.

Adhering Vial Labels

Place the vial label with a 1-D barcode **vertically** on the PreservCyt® Solution label, using the edge for alignment, as shown in Figure 7-2. A crooked label, skewed 10 degrees or more from vertical, may not scan properly.

7

OPERATING INSTRUCTIONS

Place a vial label with a 2-D barcode in the lower third of the vial, between 20 mm (0.80 in.) and 5 mm (0.20 in.) from the bottom of the vial, close to but not covering the frosted area of the vial. For the ThinPrep 5000 processor to properly read the 2-D barcode, do not put any other 2-D barcode label on the vial.

During application, avoid placing the barcode label over patient information, multiple labels, or on the torque features of the vial. Do not place labels on the vial cap or on the bottom of the vial. Sticking labels on incorrectly can cause a failure to read the barcode or a failure of the instrument removing the vial from the carousel.

The uncovered strip of the sample vial allows you to see the frosted band which indicates the maximum/minimum acceptable fluid fill range for a sample to be run on the processor. Make sure the fluid level is within this range.

Additionally, check to make sure there is no foreign matter in the vial (such as a piece of sample collection device or other non-biologic debris).

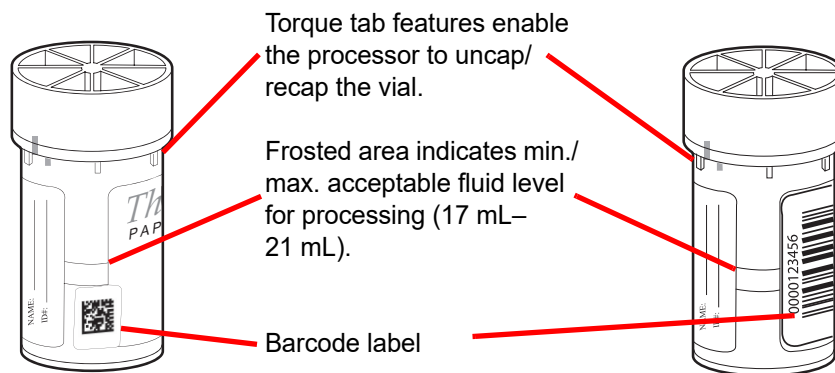

Figure 7-2 PreservCyt Solution Sample Vial

SECTION
D

LOAD THE THINPREP® 5000 AUTOLOADER

CAUTION: Prior to loading and operating the ThinPrep 5000 instrument, please note that if ancillary testing is to be performed, read and understand the instructions in “OPTIONAL INSTRUCTIONS FOR ANCILLARY TESTING” on page 7.35.

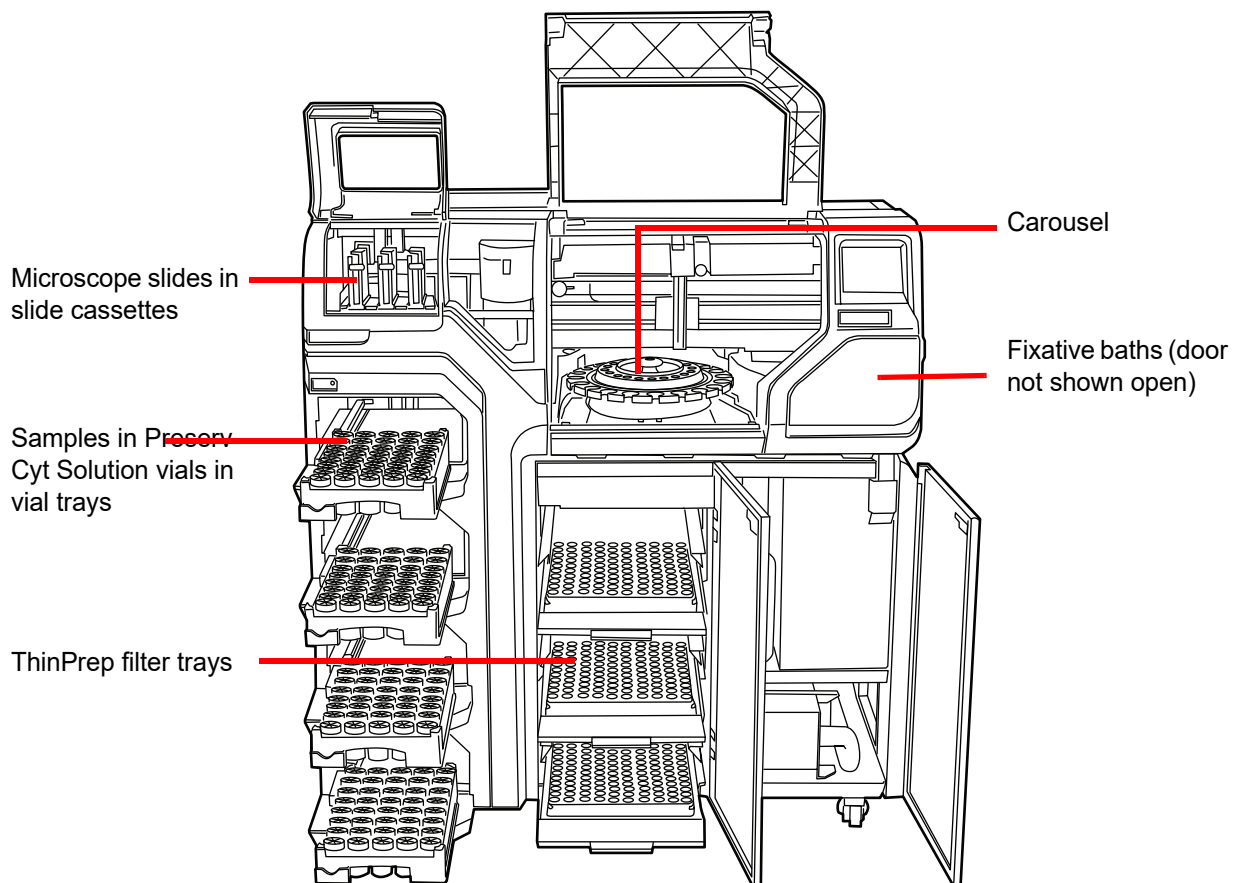





Figure 7-3 Load the Instrument



OPERATING INSTRUCTIONS

CAUTION: For best slide preparation results, use the correct slide and filter type for the sample type that is processed.

Table 7.1: Sample/Filter/Slide Configurations

	ThinPrep		ThinPrep + Imaging	UroCyt
PreservCyt sample	Gynecologic	Non-gynecologic	Gynecologic	Urine for use with Vysis UroVysion molecular testing
Filter	Clear	Blue	Clear	Yellow
Slide	Cell spot arc	Cell spot arc or arc-less	Cell spot arc with fiducial marks	Cell spot circle
				

When sample vials, filters and slides are loaded into the system, the operator must identify what type they are via the user interface.

Load Slide Cassettes with Microscope Slides

A slide cassette holds approximately 100 slides; the equivalent of an entire box of packaged ThinPrep microscope slides. The slide cassettes have a highly polished inner surface, to help the slide handler pick slides without binding. Before loading a cassette with microscope slides, gently wipe down the inside surface with a soft cloth to remove any glass dust from previous loads.

The most important part of loading slides into the cassette is to get them oriented correctly, so that the frosted area of the slide receives the laser etching. The frosted area must be facing up and toward the rear of the cassette. As a user aid, the interior of the cassette has graphic instruction for loading slides etched onto its surface.

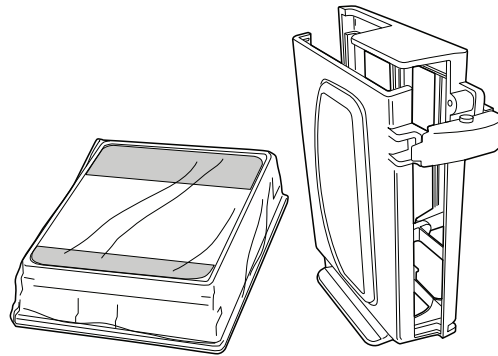

Figure 7-4 Microscope Slides and Cassette

Table 7.2: Load the Cassette with Slides

<p>1. Unlatch the clasp that holds the slide cassette closed.</p>	
<p>2. Open the cassette and clean it.</p>	
<p>3. Open a box of microscope slides. Orient the slides so that the frosted area will be facing upward in the cassette.</p>	

7

OPERATING INSTRUCTIONS

Table 7.2: Load the Cassette with Slides

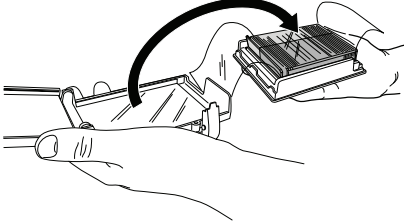
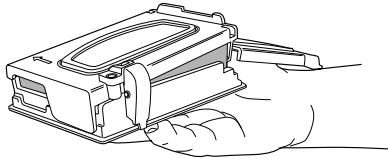
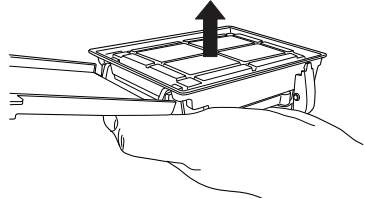
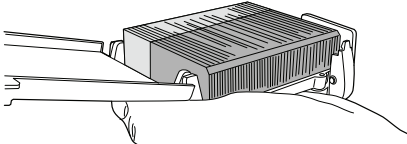
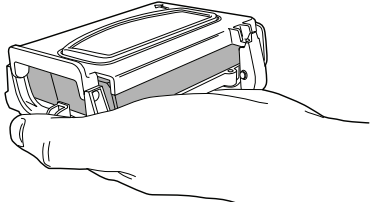
<p>4. Place the cassette onto the box of slides.</p>	
<p>5. Holding the cassette and box of slides, invert them so the slides transfer into the cassette from the box.</p>	
<p>6. Remove the slide box.</p>	
<p>7. Check for correct orientation of the slides.</p>	
<p>8. Latch the slides cassette closed.</p>	

Load Slide Cassettes into the Instrument

The AutoLoader has a slide cassette compartment where the operator loads the cassettes of microscope slides to be used in processing the samples. There are three cassette positions, marked as bay 1, 2 or 3. Push the cassette in all the way. The cassette graphic will appear on the user interface when the sensor is activated by the presence of the cassette.

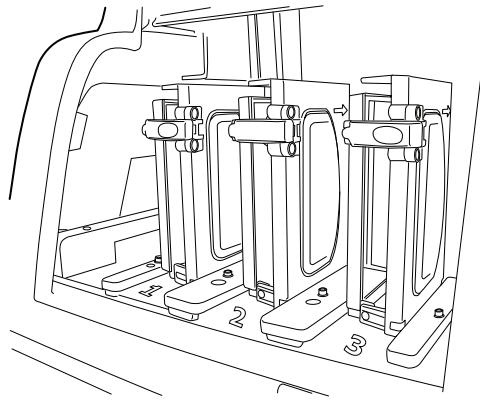

Figure 7-5 Load Slide Cassettes

The operator must identify the type of slides in each cassette. See “Slides” on page 6.6.



Load Vial Trays into the Instrument

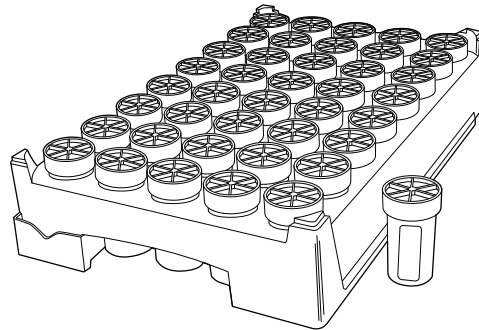

Figure 7-6 Vial Tray

The AutoLoader has four bays that hold ThinPrep sample vial trays. Each tray holds up to 40 samples. Each tray is considered a batch and a report will be generated at the completion of a tray. Each tray can only have one sample type in order to ensure that the correct filter type and slide type is used in processing the sample.

When the System Setting for tray processing is set to “Stop on empty”, then the samples must be adjacent in the tray. The batch may have less than 40 vials, but the batch will end if the system comes upon an empty position. The system will then move on to process the next tray of sample vials, if any are on board and are ready for processing.

When the setting is “Search all” and the Autoloader encounters an empty position in a vial tray, the instrument continues through all of the vial tray positions and loads any vial in the vial tray for processing. When all of the positions in a vial tray have been searched, the system will then move on to process the next tray of sample vials, if any are on board and are ready for processing.

See Figure 7-8 to see the robotic arm search pattern for sample vial trays.

The AutoLoader will not process a sample with a duplicate vial ID in the same tray. The first sample will be processed and the second sample will be treated as a sample error. If the same vial ID must be used, place the vials in separate trays.

Open the vial tray door and open the retaining latch. Slide the tray into the bay. Close the retaining latch and then close the vial tray door. The presence of the vial tray will appear on the user interface as soon as the sensor is activated by the presence of the tray. The operator must identify the type of sample in the tray for processing. See “Vials” on page 6.8.

When the vial tray doors are unlocked, a light on each door is green. When the doors are locked, the light is red.

Load Filter Trays into the Instrument

The AutoLoader has a filter compartment with three shelves that each hold a filter tray. There are clear filters for use with gynecologic samples, blue filters for use with non-gynecologic samples and yellow filters for use with UroCyte (urine) samples. Each filter tray contains 100 filters.

Note: The filters are sterile when packaged. Never touch the filter membrane or the inside of the filter cylinder prior to processing.

Note: When loading a new tray of filters, look closely to confirm that the filters are membrane-side down in the tray. Filters must be oriented with the open end up, to receive the filter plug for processing. Otherwise an error will occur.

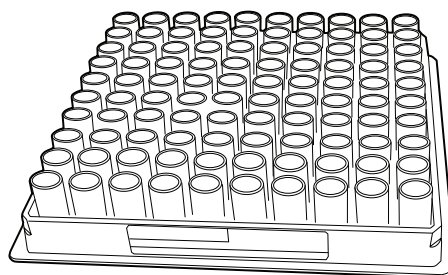

Figure 7-7 Filter Tray

Unwrap and remove the cover of the filter tray. Open the door to the filter tray compartment and pull out a shelf. Slide the filter tray onto the shelf and push it fully into the compartment. Then close the compartment door. The presence of the filter tray will appear on the user interface as soon as the sensor is activated by the presence of the tray. The operator must identify the type of filter in the tray. See “Filters” on page 6.14.

If a partially used tray is loaded, load the empty portion first (toward the back of the instrument). If the instrument finds a filter in the left rear corner, it assumes the tray is full. If it subsequently misses picking a filter after assuming a tray is full, it will throw an error. If it does not find a filter in the left rear corner, it begins a search pattern from back to front to locate the first populated filter row and then assumes all rows are populated from that point on. See Figure 7-8 to see the robotic arm search pattern for filters.

7

OPERATING INSTRUCTIONS

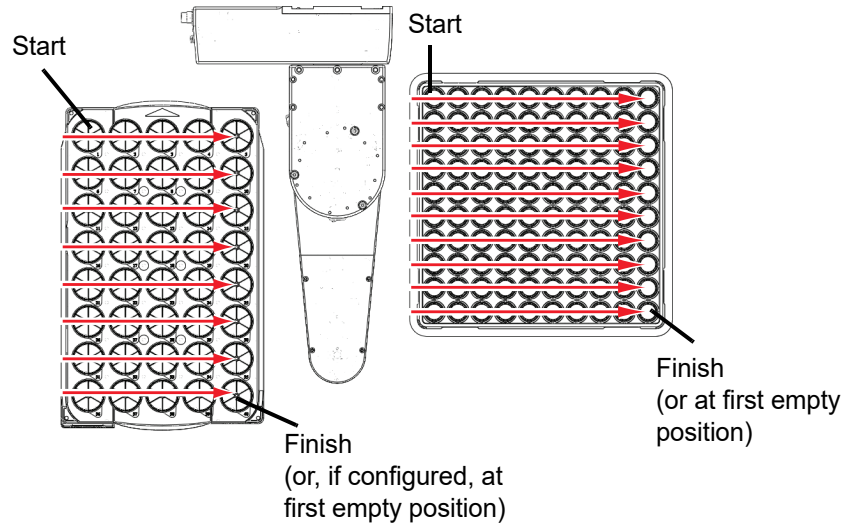

Figure 7-8 Robotic Arm Tray Search Pattern

Load Alcohol Fixative Baths into the Instrument

The processor has a baths' compartment that holds up to eight fixative baths. Each bath holds up to 20 microscope slides. Two baths are required for every sample vial tray processed. Slides from tray positions 1–20 will be deposited into one bath, and slides from tray positions 21–40 will be deposited into another bath. The system will identify the sample type based on the sample vial type.

When filling the fixative bath tubs, place an empty staining rack into the fixative bath receptacle.

IMPORTANT: Orient the rack so that the embossed words on the side that read “UP SIDE” face the handle of the bath. See Figure 7-9. It can be felt to snap into place. It is important that the rack is fully seated.

Fill the tub with alcohol until the top of the staining rack is just submerged, but not so full that the addition of slides will cause the bath to overflow.

“UP SIDE” faces bath handle.

Fill bath with alcohol up to here.

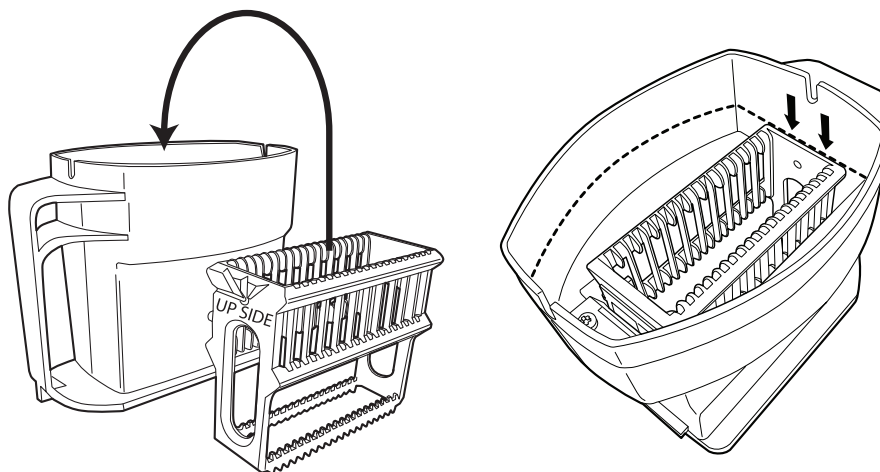

Figure 7-9 Fixative Bath and Staining Rack

If the fixative baths are left on the instrument, this fill level will be sufficient to prevent exposure of the cell spot due to evaporation for a period of up to 72 hours. Additionally, if the instrument is left idle while containing eight baths, it will rotate the bath carousel every 10 minutes so that no one particular bath is always positioned under the evaporation cover.

Note: If there is a delay between removing the fixative baths from the instrument and staining and coverslipping the slides, be aware that evaporation of the alcohol is a consideration.

Open the door to the bath compartment and slide the bath container into the slot until it stops. Close the baths doors. The system checks a fixative bath as soon as it is loaded to confirm that it is empty of slides. The operator will be alerted if an error condition is encountered.

Note: The system *cannot* sense the presence of a slide rack and assumes every bath container has one already inserted. The operator must make sure to prepare fixative baths correctly.

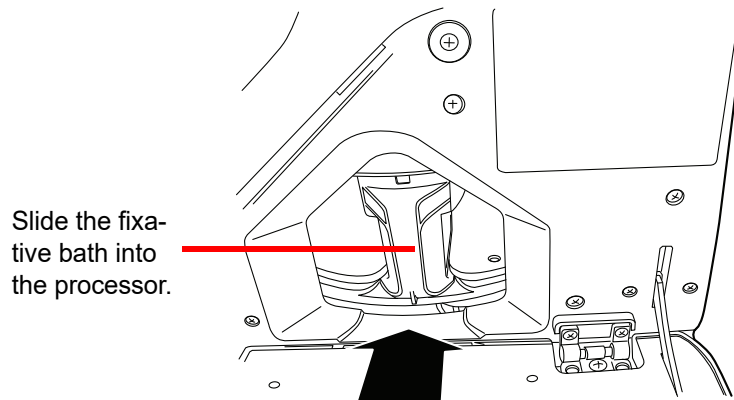

Figure 7-10 Load Fixative Bath into the Processor

See “Baths” on page 6.10 for details on loading baths and bath status indicators.

Load the Carousel into the Processor

Load an empty carousel into the processor. Open the front door and slide the tray into the center of the processing area. It is properly in place when it stops against the rear wall.

The carousel does not have to be inserted with the number 1 position oriented in a particular way. When the instrument begins processing, it will automatically align the carousel to begin processing at position 1.

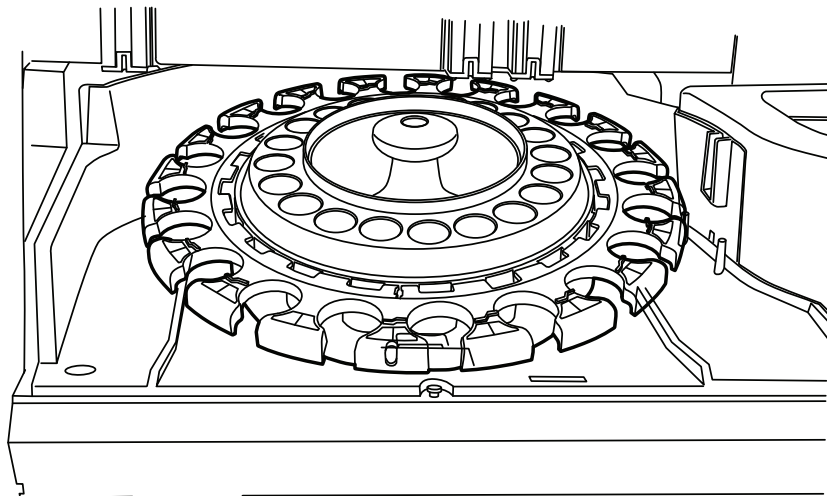

Figure 7-11 Load Carousel into the Processor

The carousel must be empty of any slides, filters or vials before an AutoLoader batch will begin.

SECTION
E

INITIATE A BATCH

When the consumable items have been placed in the instrument and any status bar warnings have been resolved, close all doors and press the **Start** button (Figure 7-12).



Figure 7-12 Start Batch Button

The doors will be heard to lock. The processor checks for the presence of vials, filters and slides. The batch preparing to process screen displays. See Figure 7-13.

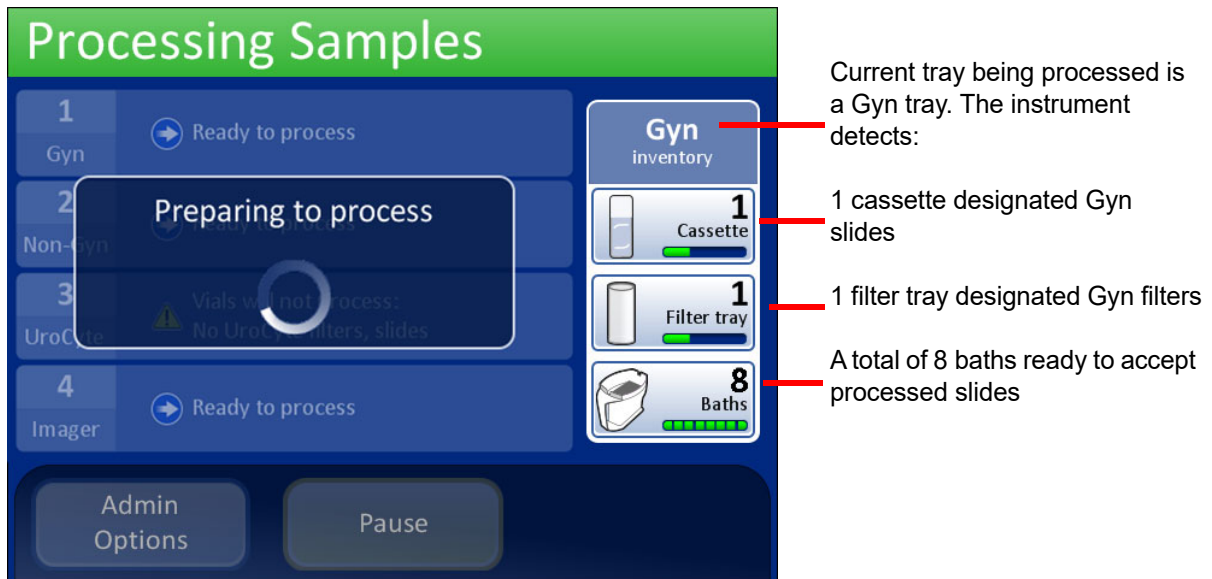

Figure 7-13 Starting the Batch Screen

The batch begins processing samples. See Figure 7-14.

7

OPERATING INSTRUCTIONS

The screenshot shows the 'Processing Samples' interface. It features a table with four rows representing different sample types: Gyn, Non-Gyn, UroCyte, and Imager. The Gyn row is currently active, showing a progress bar and a tray position indicator. The Non-Gyn and Imager rows are ready to process. The UroCyte row has a warning message. To the right, there is a 'Gyn inventory' section with three items: Cassette (1), Filter tray (1), and Baths (3). At the bottom, there are two buttons: 'Admin Options' and 'Pause'. Red lines connect these elements to explanatory text on the right.

Sample Type	Status	Message
1 Gyn	Processing	Processing sample in position 21...
2 Non-Gyn	Ready	Ready to process
3 UroCyte	Warning	Vials will not process: No UroCyte filters, slides
4 Imager	Ready	Ready to process

Progress bar and tray position indicate how much of the vial tray has been processed.

Admin Options are available, but some items are disabled during processing.

Pause the batch is available.

Figure 7-14 Processing Samples Screen

**SECTION
F**

PROCESSING SLIDES

The sequence of events that occurs when a batch is initiated goes in this order:

AutoLoader Mode		Small Batch Mode
Checks that the carousel is empty		(Operator manually loads vials, filters and slides into the carousel and loads the carousel into the processor)
Pick up the first vial, place it in the carousel and read the vial ID		
Pick a filter and put it in the carousel		Check the vial and slide IDs
Checks for slides in cassettes		
Start laser fume extractor. Pick a slide and etch it with ID from the vial ID (and any other information)		Pick up a vial and filter
Put slide in carousel and confirm the slide ID can be read and is correct		Place the vial into the disperser
Pick up slide, filter and vial and bring them to the dispersion area		Pick up the slide
Once processing begins, the system fetches subsequent vials, filters and slides	Disperse the vial contents	Disperse the vial contents
	Uncap the vial	Uncap the vial
	Place the slide on the cell transfer station (pneumatic suction holder)	Place the slide on the cell transfer station (pneumatic suction holder)
	Introduce filter to vial, wet filter and test sufficiency of fluid level	Introduce filter to vial, wet filter and test sufficiency of fluid level
	Collect cells	Collect cells
	Evacuate liquid waste	Evacuate liquid waste
	Cell transfer from filter to slide	Cell transfer from filter to slide
	Deposit slide into fixative bath	Deposit slide into fixative bath
	Puncture and dispose of filter	Puncture and dispose of filter
	Recap the vial	Recap the vial
	Return the vial to the carousel	Return the vial to the carousel
Return the vial to its original tray position		

7

OPERATING INSTRUCTIONS

SECTION G

PAUSE A BATCH IN PROCESS

To interrupt a batch in progress, press the **Pause** button. The system will finish processing the sample that is in progress. The mechanisms will move out of the way and the bath door will unlock.

Refer to “Pause a Batch” on page 6.19 for complete instruction on interrupting and resuming a batch.

SECTION H

PROCESSING COMPLETE

When a single tray has completed, the Processing Samples screen changes color to indicate that the vial tray is processed. A **View Report** button becomes available for that vial tray. The system continues processing with the next tray. See Figure 7-15.

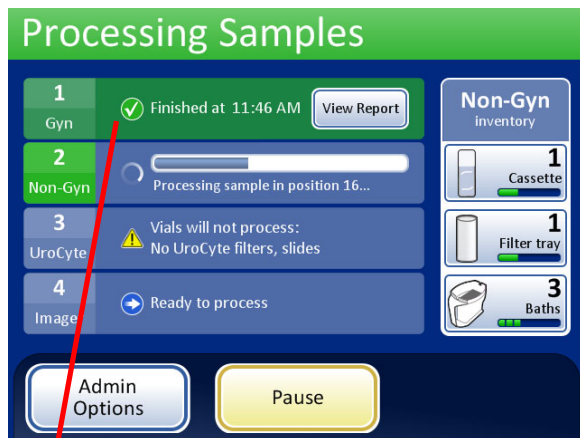

Vial Tray 1 is complete. The system is processing Vial Tray 2.

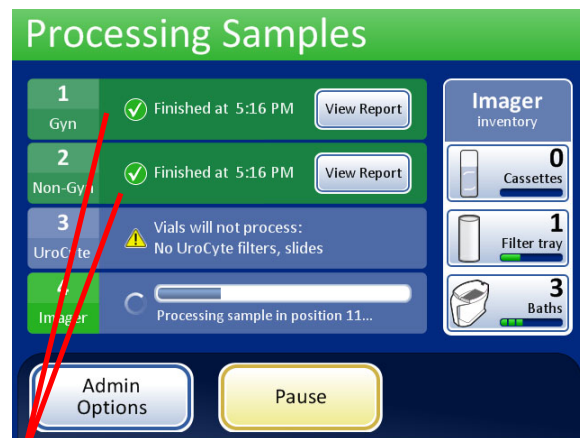

Vial Tray 1 and 2 are complete. The system is processing the next ready tray.

Figure 7-15 Processing Samples, Trays Complete

When all vial trays have been processed the system displays a Processing Complete message window. This window is displayed to indicate that all processing has finished.

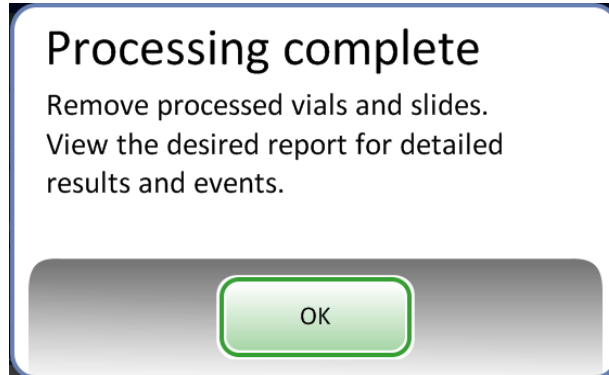
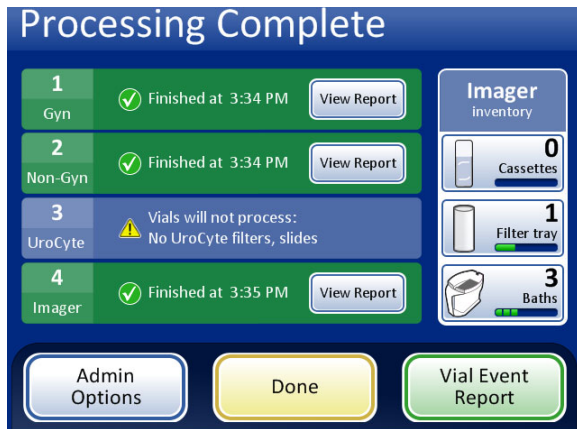
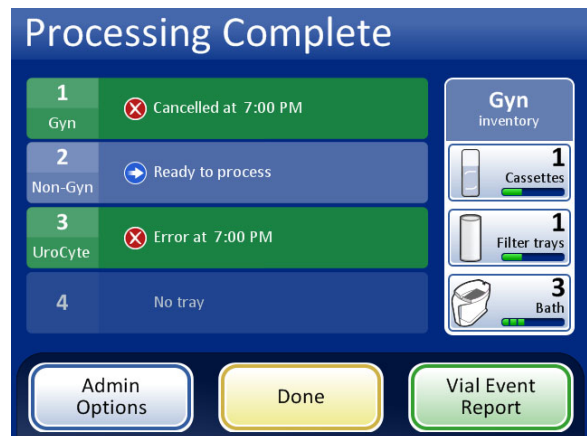

Figure 7-16 Processing Complete Message Window

Press the **OK** button to acknowledge. The Processing Complete screen is displayed.



Processing Complete, no errors. One tray was skipped due to an unresolved conflict.



Processing Complete, due to operator cancellation of the batch.

Figure 7-17 Examples of Processing Complete Screens

The batch reports are available for viewing, printing or saving to USB device. Refer to "Batch Reports" on page 6.66 for complete details of interpreting a batch report.

To leave this screen and return to the main screen, press the **Done** button.



OPERATING INSTRUCTIONS

SECTION I

UNLOAD THE THINPREP® 5000 PROCESSOR WITH AUTOLOADER

Vial Trays

Open the bays that contain processed vial trays and remove the trays.

Slide Cassettes and Filter Trays

These may be left in the instrument at the end of a batch. If they remain untouched, the instrument continues to keep track of inventory level when the next batch begins and will alert the operator when replenishment is required.

Carousel

Remove the carousel from the processor. If vials, slides and filters remain in the carousel, carefully match them against any slide or vial event in the carousel report and batch report, and reconcile the identity and disposition of the unprocessed sample.

Remove Fixative Baths

Carefully remove the fixative bath containing processed slides. If the slides will not be stained and coverslipped right away, put the evaporative covers on the bath containers.

SECTION J

SMALL BATCH MODE

Small batch mode processes sample vials directly from the carousel. One to 20 samples may be loaded as a batch. Each batch must be of one sequence type - all Gyn, all Non-Gyn or all UroCyte.

The vials do not have to be contiguous in the carousel positions.

CAUTION: The slides must be labeled with accession ID when they are loaded into the carousel. The small batch mode does not laser-etch the slide ID as it does in AutoLoader mode. (The slide reader is able to read etched or printed labels.)

CAUTION: The correct slide ID label format (OCR or barcode) must be selected prior to running the batch. This is selected from system settings in the Configure Barcodes section of the Administrative Options.

If the instrument is not in Small Batch Mode already, press the **Switch to Small Batch** button on the user interface main screen. The Small Batch Mode main interface will display (Figure 7-18).

SMALL BATCH MODE

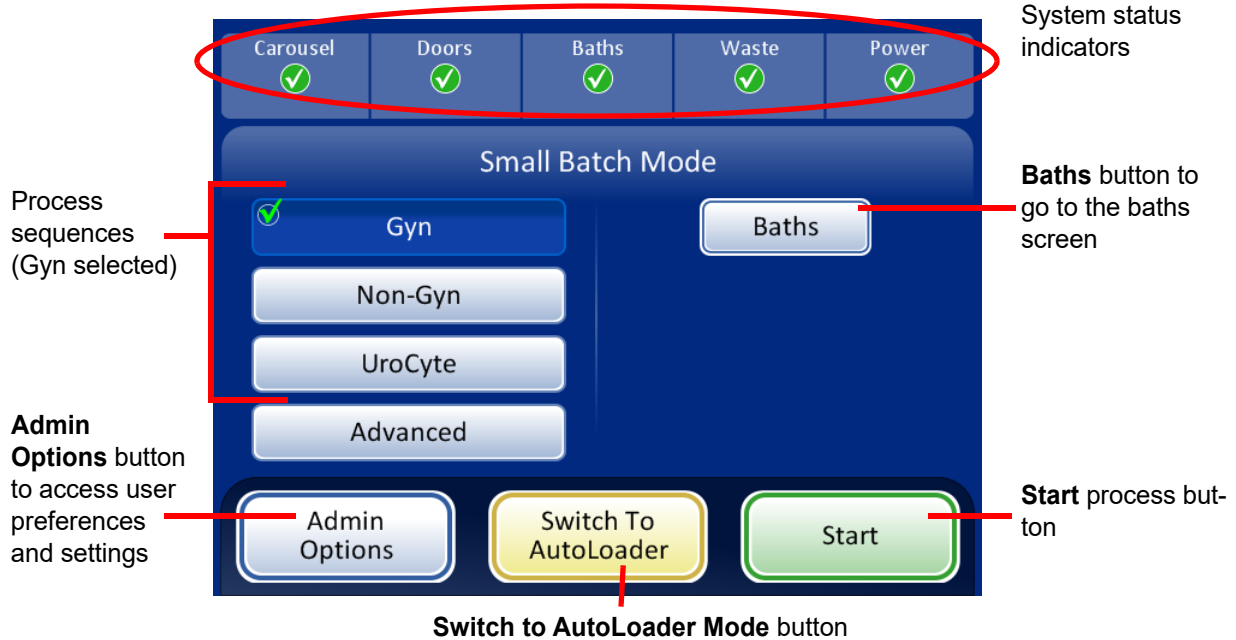

Figure 7-18 Small Batch Mode Main Screen

Status Indicators

The system status indicators are located at the top of the main screen display. All items must have a green check mark before the system will begin processing a batch.

Touch the status indicator on the screen for a brief pop-up explanation of what the status means. A table of the status indicators is shown below.

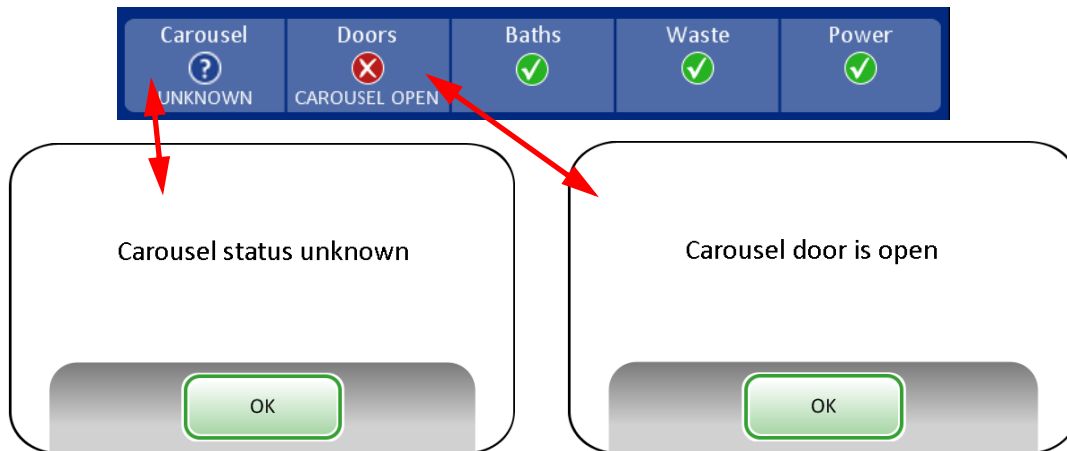













Figure 7-19 Examples of Status Indicator Messages



SMALL BATCH MODE

Table 7.3: Status Indicators

CAROUSEL	DOORS	BATHS	WASTE	POWER
 Status OK, ready to process	 Status OK, ready to process	 Status OK, ready to process	 Status OK, ready to process	 Status OK, ready to process
 Carousel not detected. Insert carousel or make sure it is in position.	 One or more doors are open. Close the doors.	 A fixative bath is not detected. Insert a fixative bath and close the door.	 Liquid waste must be emptied. See page 8.9.	 The system is running on battery power (UPS). If a batch is in process, it will finish the sample and pause the batch.
 The status of the carousel is unknown when the door is open.				 The UPS is not detected or battery is low in power.

Slide Labeling Requirements

Slides that are processed directly from the carousel must be pre-labeled, as the system does not laser-etch these samples. Note that some slides may already be laser-etched but did not process due to a sample error. These may be used as they are.

Other slides must bear a label with an accession ID that matches the ID on the vial. (Refer to Advanced Processing Options, page 7.27 for disabling slide ID match temporarily.)

Slide barcode label format

Barcode labels must be 1-D or 2-D and may have alphanumeric character strings of 5 to 14 characters with human-readable accession ID. Slide labels may be printed and applied or directly printed or etched onto the slide, but make sure the contrast is sufficient for the scanner to read the label.

The barcode label must be one of the symbologies supported:

- 1-D Code 128
- 1-D EAN-13/JAN
- 1-D Codabar (NW7)
- 1-D Interleaved 2 of 5
- 1-D Code 39
- 1-D Code 93

SMALL BATCH MODE

- 2-D DataMatrix
- 2-D QR Code

Refer to “Table 6.2: Slide Restrictions Based on Barcode Symbology Used” on page 6.39 for detailed description of constraints placed on the ID depending on the slide format used.



Figure 7-20 Examples of How Barcodes Fit onto a ThinPrep Slide

The barcode must have a minimum height of 0.22 inch (5.88 mm) and a maximum width no wider than 0.75 inch (19.05 mm).

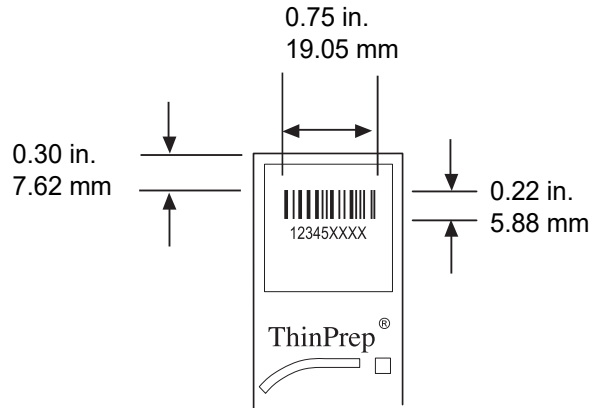

Figure 7-21 Barcode Slide Label Format

Slide OCR label format

For slides that will be used with the ThinPrep Imaging System, OCR label format must be 14 characters long (which reserves the last 3 characters as check characters). See Figure 7-23.

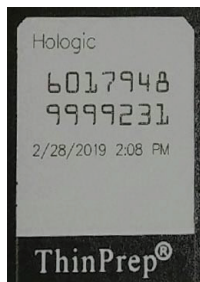

Figure 7-22 Example of a Laser-printed OCR Label on a ThinPrep Slide



SMALL BATCH MODE

Required slide label format for use with the ThinPrep® Imaging System

For ThinPrep Pap test slides that will subsequently be imaged by the ThinPrep Imaging System Imaging Station, slide labels must be in an OCR, 14 character, 7-digits-over-7-digits format, with the last 3 digits being a CRC number. The font must be 12 point OCR-A. Numbers only, no alpha characters.

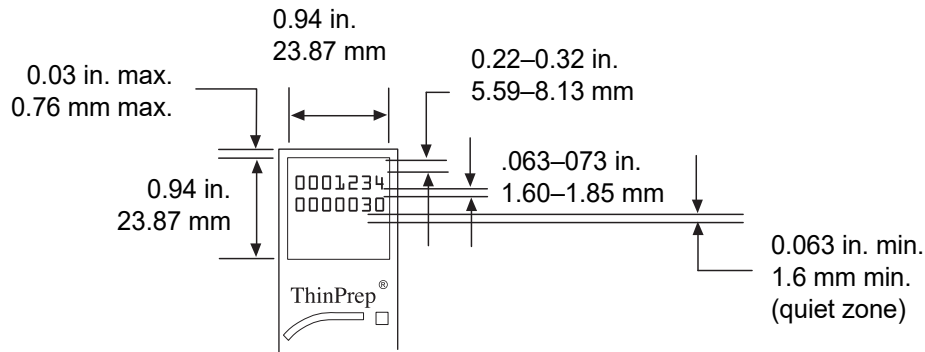

Figure 7-23 Slide OCR Label Formats

Slide labels that are applied to the microscope slide must be compatible with staining and coverslipping processes and be xylene-resistant. When adhering the labels, be sure to apply them smoothly to the frosted area of the slide, with no overhang or air bubbles. Labels should be centered side to side. The OCR or barcode IDs must be in an area that the scanner is able to read, as seen in Figure 7-23.

Load Vials, Filters and Slides into the Carousel

CAUTION: For best slide preparation results, use the correct slide and vial type for the sample type that is processed.

Load the correct filter type and slide type for each vial. (Refer to Table 7.4.) The batch can hold up to twenty samples. If the batch is not fully loaded, the samples do not have to be contiguous within the carousel.

SMALL BATCH MODE

Table 7.4: Sample/Filter/Slide Configurations

	ThinPrep		ThinPrep + Imaging	UroCyt
PreservCyt sample	Gynecologic	Non-gynecologic	Gynecologic	Urine for use with Vysis UroVysion molecular testing
Filter	Clear	Blue	Clear	Yellow
Slide	Cell spot arc	Cell spot arc or arc-less	Cell spot arc with fiducial marks	Cell spot circle

Load the labeled vials into the carousel. Load the corresponding slide into the slot behind the vial. Load the slide so that the front side (cell spot side) faces outward. **Only handle slides by the edges - never touch the surface within the cell spot area.**

Load the filter into the position behind the vial and slide. Load the filter by grasping the sides of the cylinder. Place it into the position with the membrane end down and the open end up. **Never touch the filter membrane or the inside of the cylinder.**

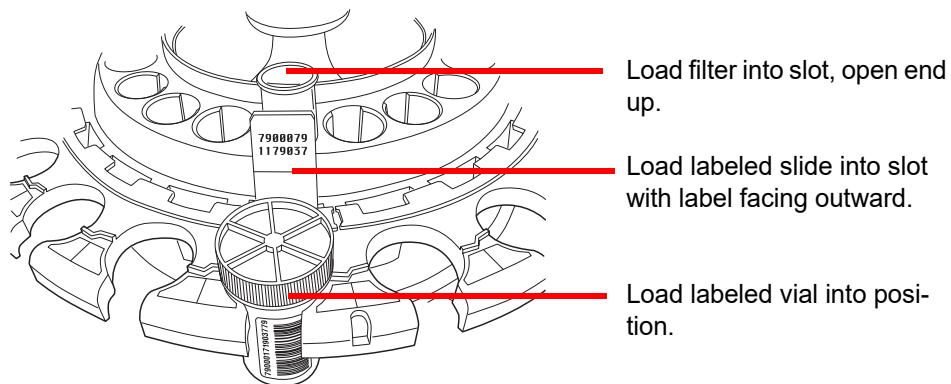

Figure 7-24 Load Carousel with Vials, Slides and Filters



OPERATING INSTRUCTIONS

SMALL BATCH MODE

Note: The filters, slides and vials can be loaded in any order that is convenient for loading (filters then slides then vials), as long as the patient ID labels match up.

Load the carousel into the processing area. (Refer to page 7.14.)

Fill and load fixative baths into the bath compartment. (Refer to page 7.13.)

Select the Sample Processing Sequence

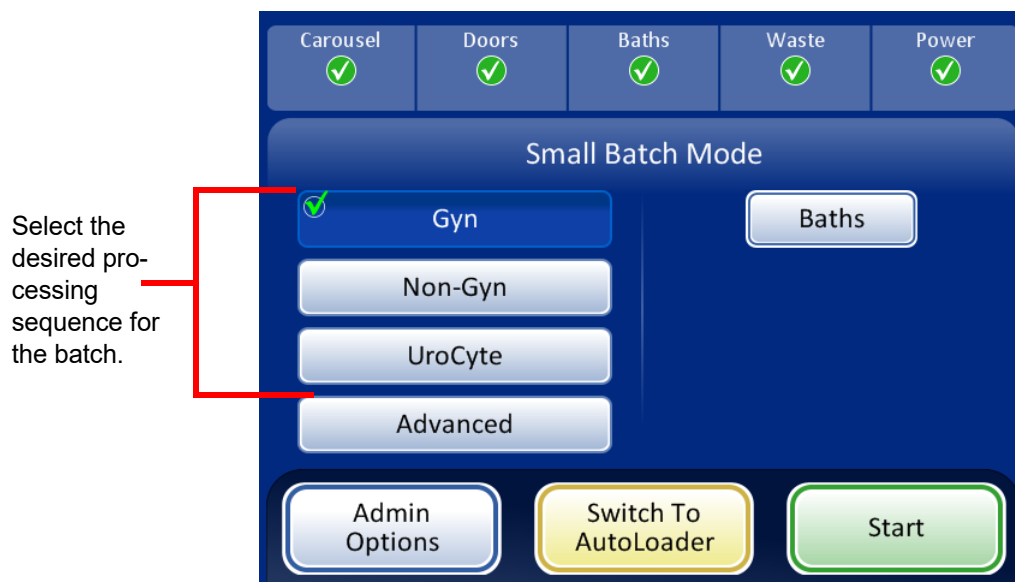

Figure 7-25 Sample Processing Sequence

Gyn for running a batch of gynecologic samples

Non-Gyn for running a batch of non-gynecologic samples

UroCyte for use with urine in the Vysis® UroVysion assay

Advanced enables selection of:

Disable slide ID match, which allows one sample to be run with the vial/slide ID match turned off. One vial of any sample type may be processed: gynecologic, non-gynecologic or UroCyte. A “Chain of custody is off” message displays on the screen during processing.

Multiple slides per vial, which processes a non-gynecologic specimen and extracts from 1 to 10 samples from the same vial. The system will bypass the fluid level too low check when processing multiple samples per vial.

SMALL BATCH MODE

Disable slide ID match

Disable slide ID match - in order to run a sample with the vial/slide ID match turned off.

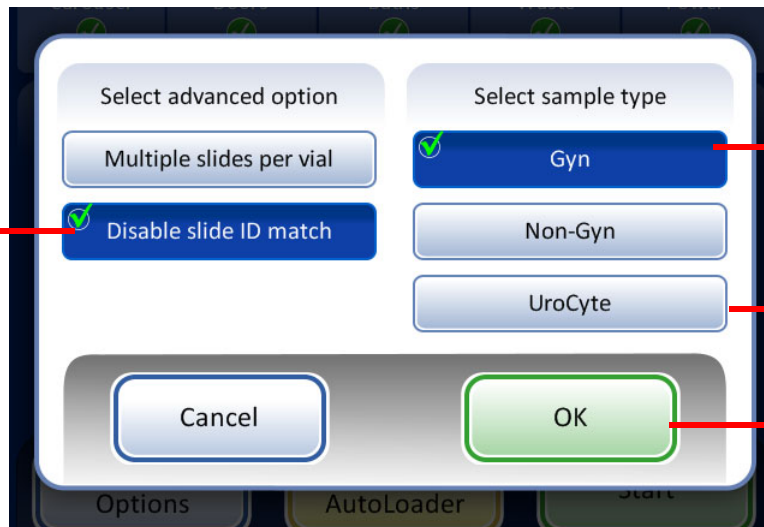

Select sample type in order to run the correct process sequence.

OK button to accept the selection and return to main screen

Figure 7-26 Disable Slide ID Match

To run the specimen:

1. Load one vial and appropriate filter and slide type into any position on the carousel.
2. Load the carousel into the processor.
3. Put a filled fixative bath - with empty slide rack - into the bath compartment.
4. Close all doors.
5. Press the **Advanced** button on the main screen.
6. Press the **Disable slide ID match** setting button.
7. Select the sample type that is to be processed, and press the green **OK** button.
The display returns to the main screen. Advanced is selected, and the selected options are detailed next to it. See Figure 7-27.
8. Press the **Start** button to process the sample.



OPERATING INSTRUCTIONS

SMALL BATCH MODE

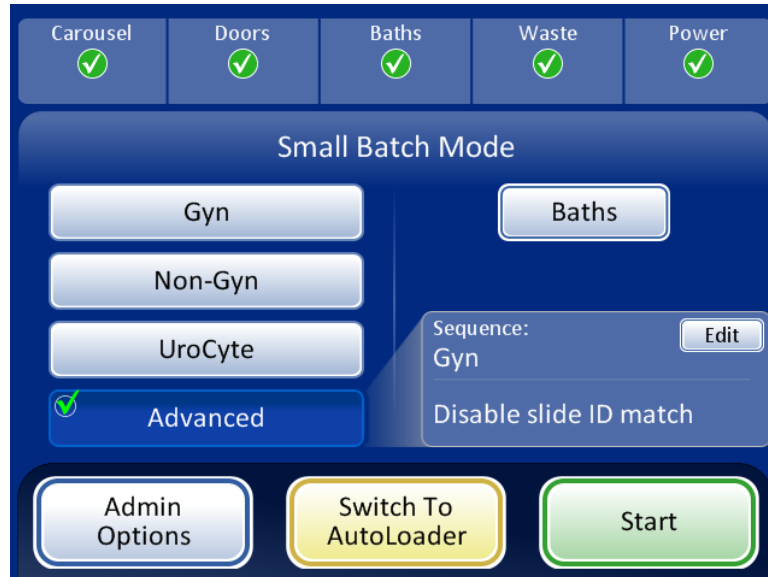

Figure 7-27 Disable Slide ID Match Selected

Note: When the sample has been processed, the system reverts to Slide ID Match ON. To process another sample without the vial/slide ID match, repeat the steps above.

Note: Only one vial may be loaded into the carousel. Prior to processing, the instrument checks that it senses only one vial. If more than one vial is present, the batch will not proceed.

SMALL BATCH MODE

Multiple slides per vial**Figure 7-28 Multiple Slides per Vial**

Multiple slides per vial allows you to run a non-gynecologic specimen and extract from 1 to 10 samples from the same vial. The system will bypass the fluid level too low check when processing multiple slides per vial.

To process a sample:

1. Load a non-gynecologic sample vial into position 1 of the carousel. (Must be in position 1.)
2. Load a non-gyn filter into the filter slot and a slide into the slide slot. Load the adjacent filter and slide slots with the number of desired samples to be made (from 2 to 10).
3. Load a filled fixative bath - with an empty slide rack - into the baths compartment.
4. Close all doors.
5. Press the **Advanced** button on the main screen.
6. Press the **Multiple slides per vial** setting button. (Note that the non-gynecologic sequence is the only choice.) Press the green **OK** button.
The display returns to the main screen. Advanced is selected, and the selected options are detailed next to it. See Figure 7-29.
7. Press the **Start** button to process the sample.



OPERATING INSTRUCTIONS

SMALL BATCH MODE

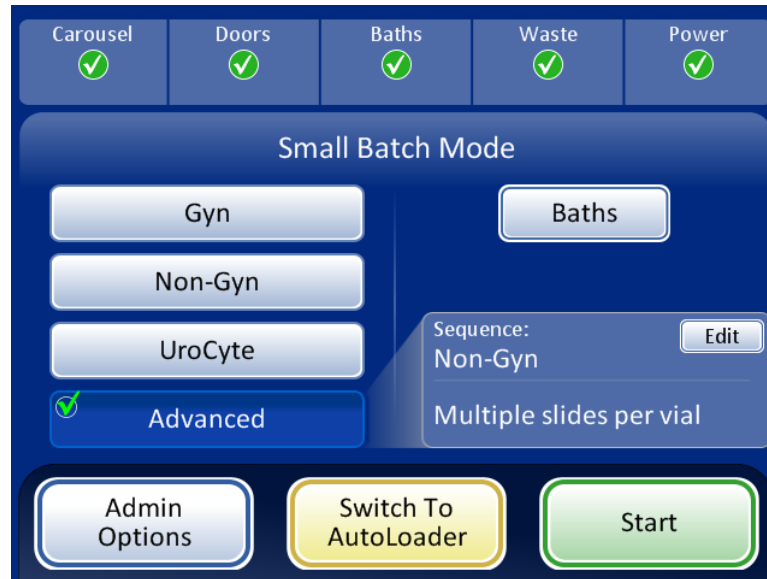

Figure 7-29 Multiple Slides per Vial Selected

Initiate a Batch

When the input carousel has been loaded with labeled sample vials, the appropriate filters and slides, and a fixative bath is ready in the bath compartment, select the sample processing sequence, and press the **Start** button (Figure 7-30).



Figure 7-30 Start Batch Button

The main door and bath door will be heard to lock. The processor goes through a pre-check and scans for the presence of vials in the carousel. It counts the number of vials, which is displayed on the progress bar.

The Batch Processing screen displays. See Figure 7-31.

SMALL BATCH MODE

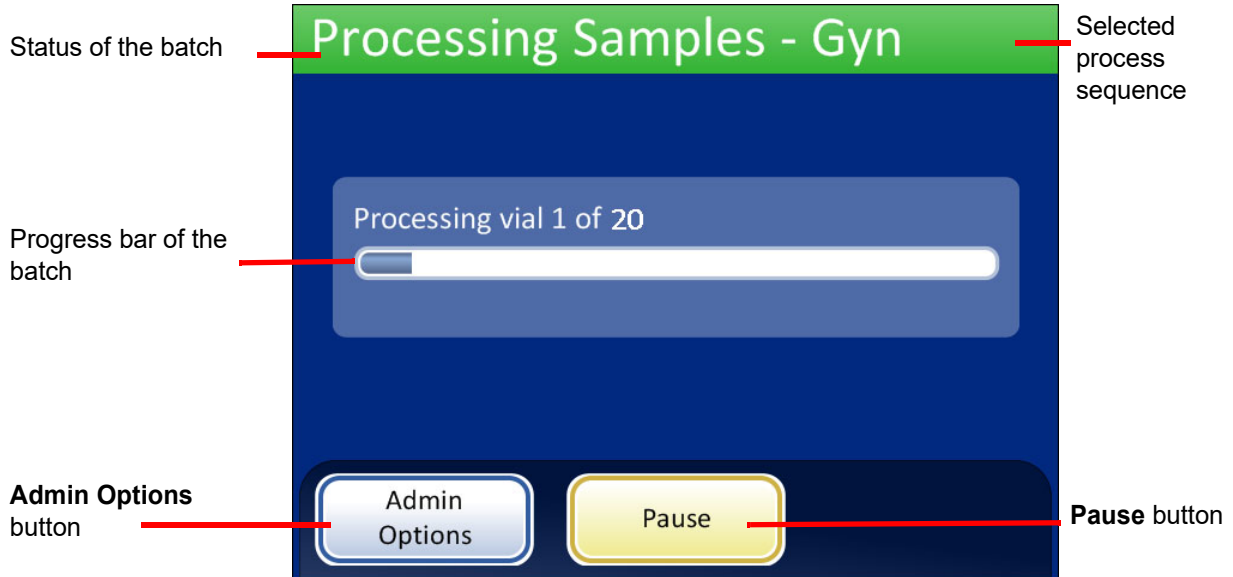
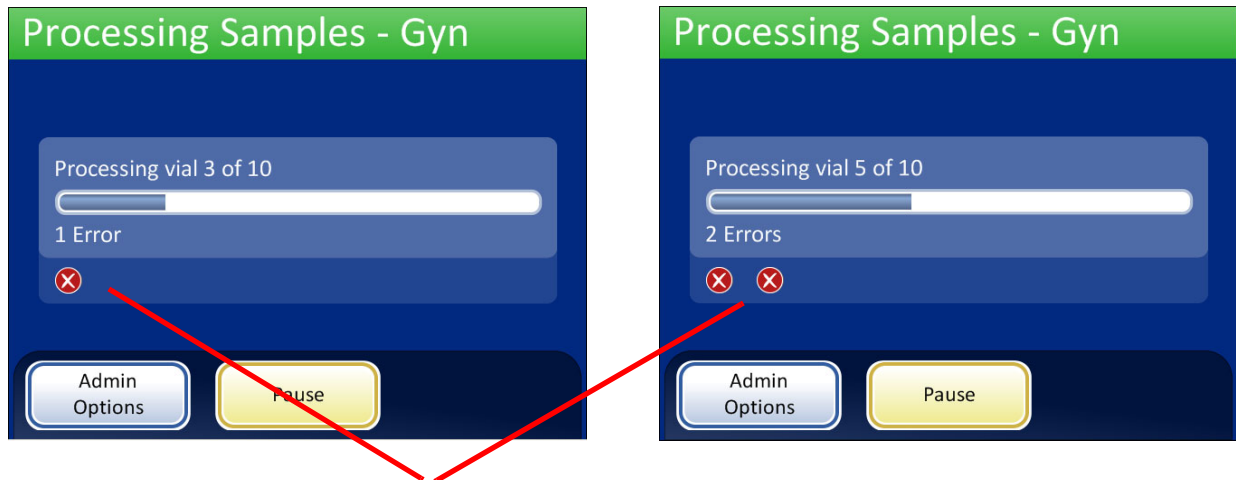

Figure 7-31 Starting the Batch Screen

During processing, a progress bar indicates how much of the batch has been completed. It increments during the processing of each vial, as well as to indicate overall batch progress.

If a sample error occurs, the batch continues, but an error indicator is displayed on the batch screen, as shown in Figure 7-32.



Sample error indicators are displayed on the screen during processing.

Figure 7-32 Sample Errors During Small Batch Sample Processing



SMALL BATCH MODE

Refer to “PROCESSING SLIDES” on page 7.17 for a detailed list of events that take place during processing.

Pause a Batch

A batch may be paused by pressing the **Pause** button.

When the **Pause** button is pressed the system will complete processing the current vial and then pause.

The batch status line will report “Interrupting” as the processor puts items away and parks the mechanisms.

The Batch Paused screen will display when the processing sequence is safely paused. Only the bath door is unlocked. See Figure 7-33.

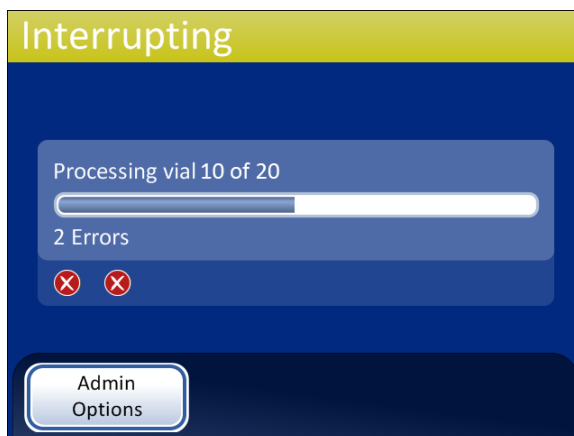

After pressing the **Pause** button, the status changes to Interrupting as the system finishes the vial in progress and parks the mechanisms.



The batch is paused.

Baths button displays the baths screen.

Stop Processing button ends the batch.

Continue button continues with the batch in process.

Figure 7-33 Interrupting Processing and Processing Paused Screen

While the batch is paused, only the baths area can be accessed. Press the **Baths** button to view the Baths screen.

Completed slides may be unloaded by removing the fixative bath from the baths compartment. If the batch will resume, a fixative bath with no slides must be loaded.

Note: If the fixative bath is slid out of the compartment slot far enough to disengage with the sensor, a new bath without any slides must be loaded in order to resume the batch. Otherwise the “No baths available” message will keep repeating.

SMALL BATCH MODE

Close the door and press the **Done** button to transition from the Baths screen back to the Paused screen.

Press the **Continue** button when ready to continue with the batch.

Press the **Stop Processing** button to end further processing for that batch. A confirmation screen will appear (Figure 7-34.)

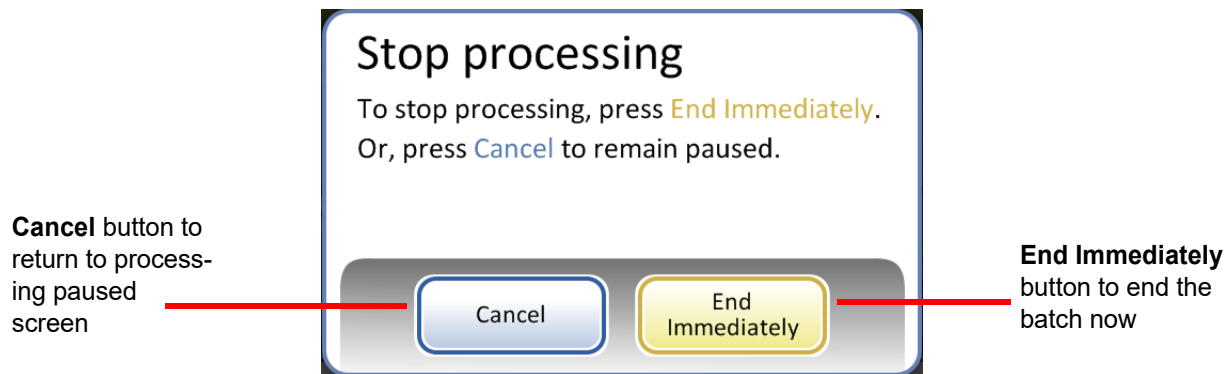

Figure 7-34 Stop Processing Screen

Press the **Cancel** button to return to the processing paused screen.

Press the **End Immediately** button to end the batch now. The Batch Complete screen will display. Refer to the next section.

Processing Complete

When a batch has completed processing, the processor returns to an idle state, with a Processing Complete message on the screen. See Figure 7-35. The doors unlock. If an alarm sound has been set for batch completion, it will sound briefly.

Press the **OK** button to acknowledge the Processing Complete message and view the Processing Complete screen.



SMALL BATCH MODE

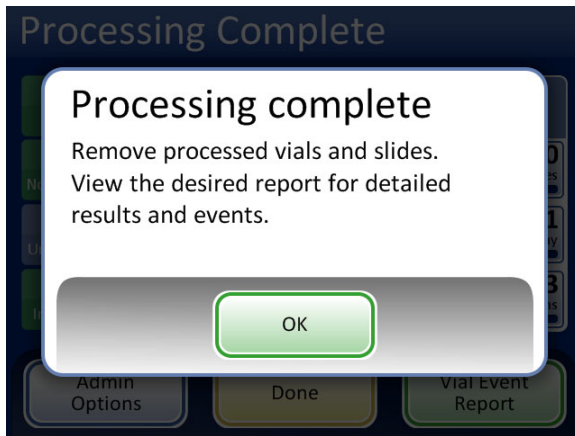

Processing Complete message



Batch Report button displays the report.

Done button returns to the main screen, idle.

Figure 7-35 Processing Complete Screen

To view the batch report, press the **Batch Report** button. The report will display, and there is the opportunity to print the report or save it to USB key via that screen. (That can also be done at a later time, using the Reports function in Admin Options.) When the report screen is exited (by pressing the **Done** button), you return to the Batch Complete screen.

The screen will remain until the operator acknowledges by pressing the **Done** button.

Batch Report



Batch report, status OK



Batch Report, batch ended due to error

Figure 7-36 Examples of Small Batch Mode Batch Reports

The batch reports are the same as described for AutoLoader on page 6.66, except the carousel positions are listed instead of vial tray positions.

**SECTION
K****OPTIONAL INSTRUCTIONS FOR ANCILLARY TESTING**

Testing for certain sexually transmitted diseases (STD) and for Human Papilloma Virus (HPV) in conjunction with cytology may be enabled by the removal of an aliquot of up to 4 mL (Aliquot Removal) from the PreservCyt® sample vial before preparing the ThinPrep Pap test slide.

Laboratory personnel must follow the specific instructions in this section to appropriately remove the desired aliquot volume and prepare the PreservCyt sample vial for the ThinPrep® Pap test. Adherence to these instructions must be maintained to ensure there is no adverse effect on the ThinPrep Pap test result.

Because cytology/HPV testing and STD testing address different clinical questions, Aliquot Removal may not be suitable for all clinical situations. Physicians and other persons responsible for ordering clinical tests should be familiar with the following:

- There is no evidence of degradation of cytology results by Aliquot Removal, however, this cannot be ruled out for all specimens. As with any subsampling step in anatomic pathology, chance misallocation of diagnostic cells may occur but they are very rare. If negative results from the specimen do not fit with the clinical impression, a new specimen may be necessary.
- Aliquot Removal from low-cellularity specimens may leave insufficient material in the PreservCyt sample vial for preparation of a satisfactory ThinPrep Pap test slide.
- Aliquot Removal may leave insufficient material in the PreservCyt sample vial for performance of ancillary testing (e.g., reflexive HPV testing) using the residual specimen following preparation of a ThinPrep Pap test slide.
- Co-collection of separate samples for the ThinPrep Pap test and STD testing may be considered in lieu of Aliquot Removal.
- When opting for concurrent cytologic and STD testing, providers should consider risk and clinical history (e.g., disease prevalence, patient age, sexual history or pregnancy) as well as specimen suitability (e.g., exudates or bleeding) that can impact diagnostic reliability.

Sexually Transmitted Diseases Treatment Guidelines 2002 (Centers for Disease Control and Prevention, MMWR 2002: 51(No. RR-6)) provides clinical guidance for the management and treatment of individual patients, including use of Pap testing.

It is contraindicated to perform *Chlamydia trachomatis* and *Neisseria gonorrhoeae* testing, using the Roche Diagnostics COBAS AMPLICOR CT/NG Test, if the sample has already been processed using the ThinPrep 5000 processor.

Removing an Aliquot (of up to 4 mL) from the PreservCyt Sample Vial prior to Performing the ThinPrep Pap Test

Note: Only one aliquot may be removed from the PreservCyt sample vial prior to performing the ThinPrep Pap test, regardless of the volume of the aliquot (maximum aliquot volume = 4 mL).



OPERATING INSTRUCTIONS

Note: Good laboratory practices should be followed to avoid introducing contaminants into either the PreservCyt® sample vial or the aliquot. It is recommended to use powder-free gloves and an individually wrapped, disposable pipetting device with an aerosol barrier tip that is sized appropriately for the volume being withdrawn and dispensed. You should not use serological pipettes. In order to minimize the potential for cross contamination, aliquot removal should be performed in an appropriate location outside an area where amplification is performed.

1. Vortex the vial at high speed for 8 to 12 seconds.

CAUTION: The desired aliquot must be removed immediately after vortexing the vial to ensure homogeneity of the sample.

2. Carefully remove the vial cap.

3. Using a pipetting device, withdraw an aliquot of up to 4 mL from the vial. Take care to avoid contaminating gloves with solution. If gloves should become contaminated, replace with a clean pair before proceeding to the next specimen.

4. Dispense the aliquot into a suitably sized and labeled polypropylene tube and close tightly to prevent leakage/evaporation.

5. Store the aliquot under conditions appropriate for ancillary test(s). Refer to manufacturer or laboratory instructions for performing ancillary test(s) on the aliquot.

6. Dispose of the pipetting device in accordance with local, state, and federal regulations.

7. Using a new pipetting device, withdraw a quantity of unused PreservCyt Solution from its container that is equal in volume to that of the aliquot removed from the vial in step 3.

8. Transfer the volume of unused PreservCyt Solution to the vial from which the aliquot was removed in step 3.

9. Secure the vial cap. (The line on the cap and line on the vial should meet or slightly overlap.)

10. Dispose of the pipetting device in accordance with local, state, and federal regulations.

11. Refer to the sections in this chapter to complete the ThinPrep® Pap test.

Chapter Eight

Maintenance

Table 8.1: Routine Maintenance

Daily or more	Change fixative every 100 slides or daily, whichever comes first.
	Before filling a slide cassette, wipe down the inside with a dry, non-abrasive cloth.
Weekly	Clean around the slide cassettes, the carousel and dispersion area.
	Clean slide holder pneumatic suction cups at the slide cassette area and the processing area.
	Check and empty the filter waste bin and the slide waste bin.
As needed	Empty waste bottle.
	Clean the touch screen.
	Check and empty material left in the robot arm elevator shaft.
	Clean input carousel and dust cover.
	Change absorbent pads.
	Remove and clean drip trays.
	Change the fume extractor carbon filter yearly or as desired.
	Change the fume extractor HEPA filter when prompted by the instrument.

8

MAINTENANCE

SECTION A

DAILY

Change Fixative Reagent

The fixative alcohol in any bath should be changed out every 100 slides, or daily, whichever comes first. Consider how your laboratory uses baths in the count to 100. For example, one bath used with 20 slides for 5 batches needs the fixative alcohol changed before the next batch is run (or daily).

- Dispose of fix reagents according to your laboratory's protocols.
- Clean the fixative bath containers, covers and staining racks according to your laboratory's protocols.

Wipe Down Slide Cassette

Before filling a slide cassette, wipe down the inside using a dry, non-abrasive cloth. This will keep down glass dust and help the slides to be removed more easily.

If you notice that slides are sticking together or pick errors occur, make sure the cassettes are clean.

SECTION B

WEEKLY CLEANING

Slide Cassette Area

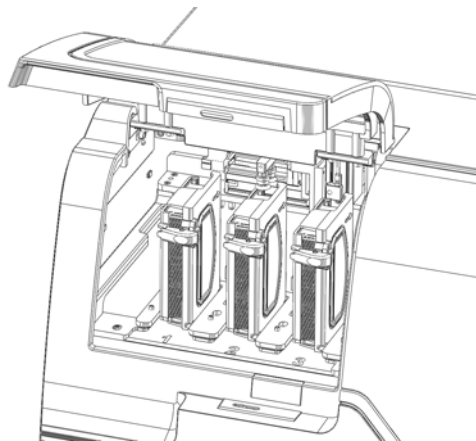

Figure 8-1 Slide Cassette Area

Open the door to the slide cassette compartment. Remove slide cassettes that are present and clean around the area using deionized water and lint-free cloths.

Clean System



Use the **Clean System** button in several weekly maintenance activities. The **Clean System** button moves the mechanical arms in the processing area to positions that make them easier to reach for routine maintenance.

1. Touch the **Clean System** button and the display screen guides the operator through the process.
2. Close the doors and press **Continue**. Keep the doors closed while the instrument is moving parts.

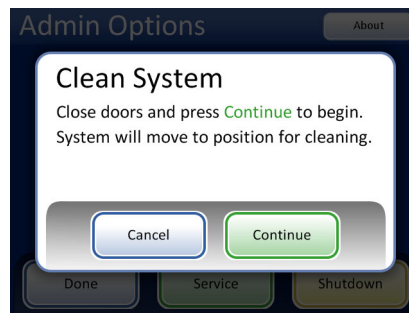

3. When the screen display says, "Follow instructions in manual for cleaning," open the door(s) and perform the routine maintenance cleaning tasks. Refer to "Clean Around Carousel And Dispersion Areas" on page 8.5 and "Clean Slide Holder Pneumatic Cups, AutoLoader Slide Gripper and Sensor" on page 8.6.

In this state, the vial/filter transport arm and the slide transport arm can each move freely along their tracks. Gently slide the arms to positions convenient for cleaning the various parts of the instrument.

The robot arm near the slide cassettes moves the slide holder with suction cups and the slide pick arm towards the processing area to make them accessible for cleaning.

And, the mechanisms in the filter waste area move toward the processing area to make them easy to reach for cleaning.

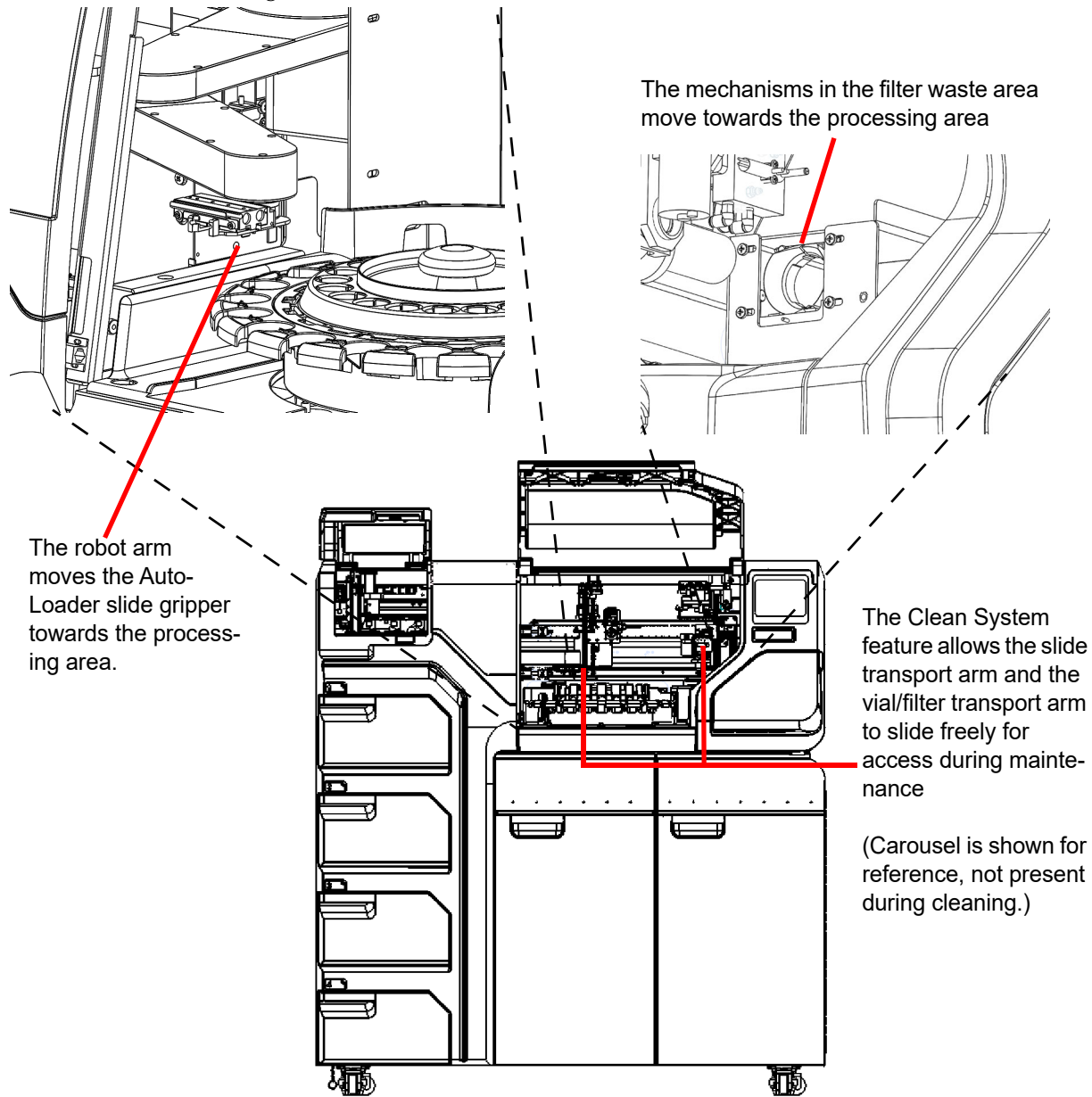
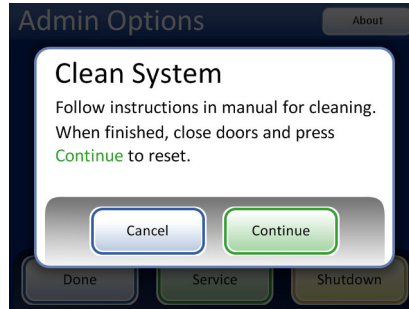

Figure 8-2 Clean System

- When you are finished cleaning, close the doors and touch the **Continue** button. The instrument resets the mechanisms.



- Press **Done** to return to the Admin Options screen

Clean Around Carousel And Dispersion Areas

On a weekly basis, remove the carousel and clean around the bottom of the processing area, using deionized water and lint-free towels. Do not dislodge the carousel sensors, but do keep the area around them clean and make sure nothing blocks them. See Figure 8-3.

Use the Clean System feature to help move instrument mechanisms out of the way. See “Clean System” on page 8.3.

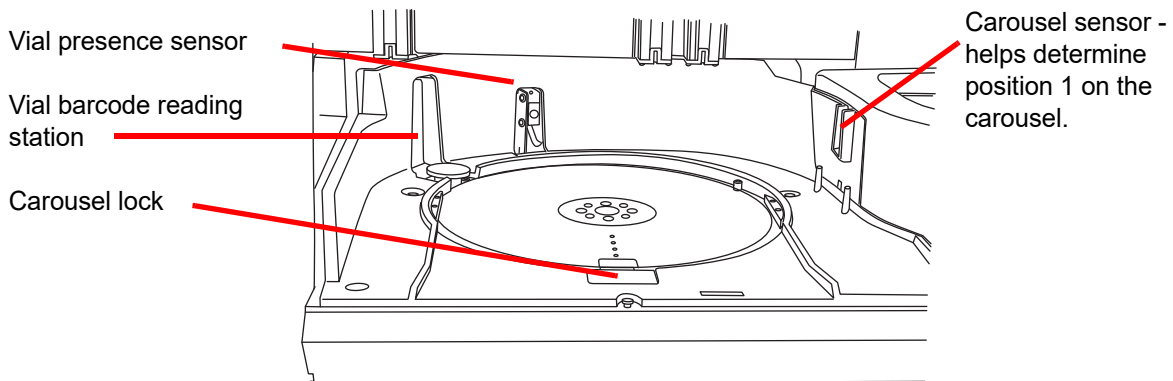

Figure 8-3 Carousel Sensors

Clean around the dispersion well and the evaporative cover over the fixative bath.

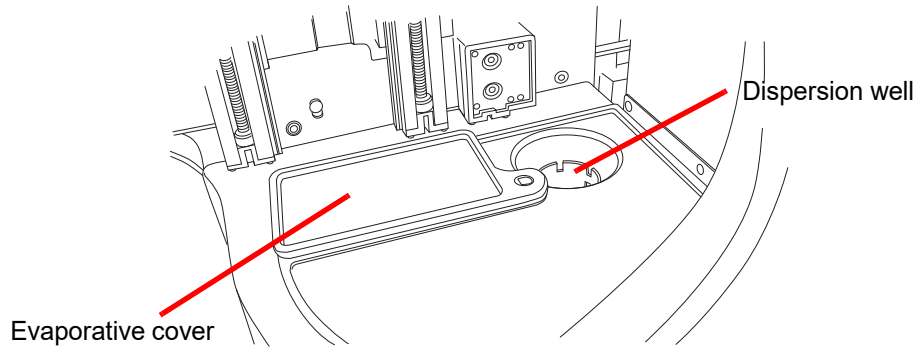

Figure 8-4 Clean Dispersion Well Area

If there is buildup of residue from PreservCyt Solution on the filter plug, around the filter puncture point area and other surfaces surrounding the filter waste area, use a cloth or swab soaked with 70% alcohol to dissolve any crust and clean away precipitate.

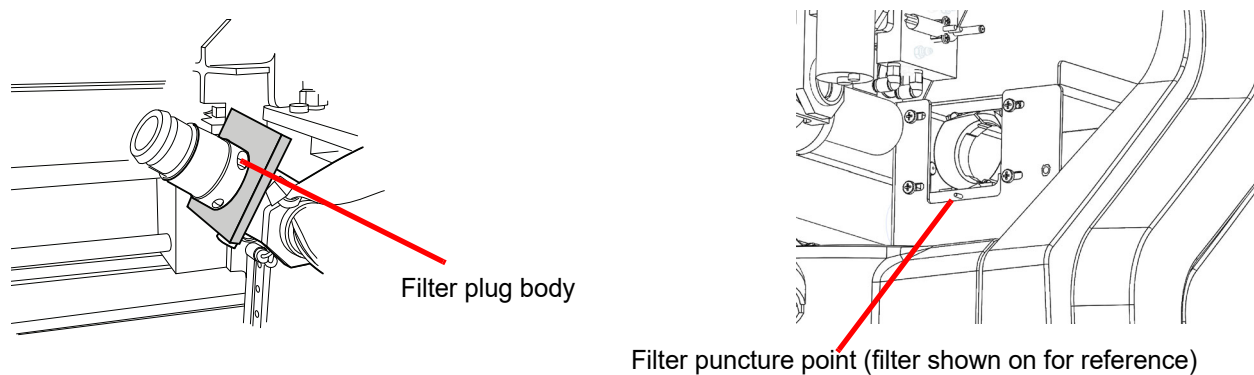

Figure 8-5 Clean Filter Plug and Filter Puncture Area

Clean Slide Holder Pneumatic Cups, AutoLoader Slide Gripper and Sensor

A lint-free cloth soaked with de-ionized water may be used to wipe down the surfaces of the slide holder cups. Wipe any glass dust out of the AutoLoader slide gripper area. Be sure to let the suction cups dry (5–10 minutes) before attempting to process slides on the instrument.

One set of slide holders is located on the slide pick arm in the slide cassette area (Figure 8-6).

Note that there is a sensor on the slide pick arm. Wipe off the lens of the sensor when the suction cups are cleaned.

The other set of pneumatic slide cups is located on the slide transport arm in the processing area.

Use the Clean System feature to help move instrument mechanisms out of the way. See “Clean System” on page 8.3.

Wipe off sensor lens and suction cups.

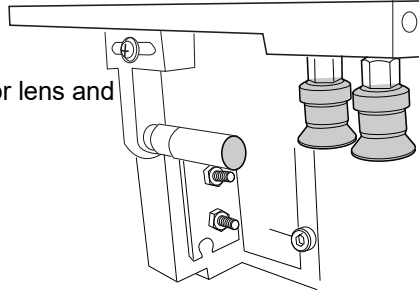

Slide cassette compartment

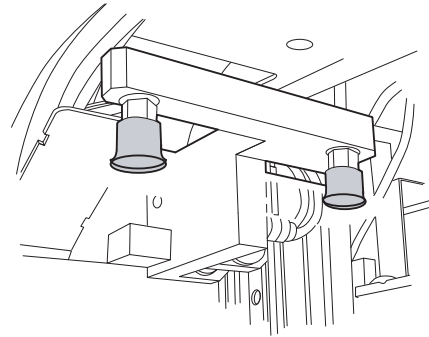

Slide processing area

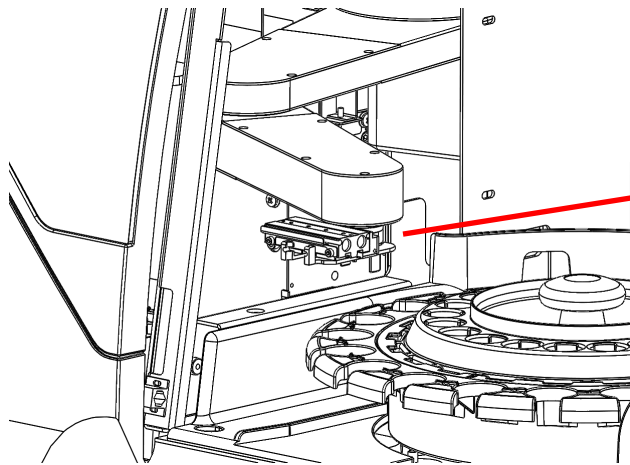

AutoLoader slide gripper on the robot arm

Figure 8-6 Clean Slide Holder Pneumatic Suction Cups

Empty the Filter and Slide Waste Bins

The right-most cabinet of the AutoLoader is the waste area compartment. Open this door to access the filter waste bin and the slide waste bin. (The liquid waste bottle and the fume extractor are also located in this area.) See Figure 8-7.

8

MAINTENANCE

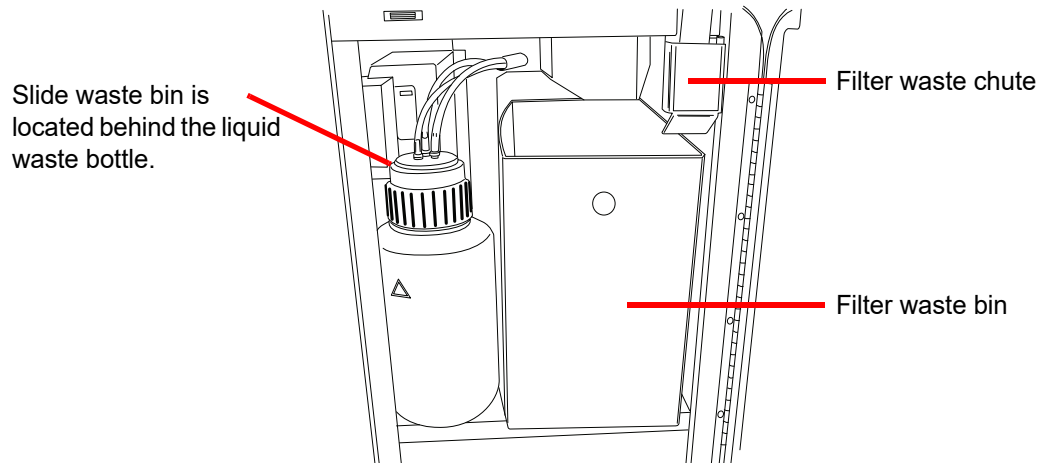

Figure 8-7 Waste Cabinet Door Open

On a weekly basis pull out the filter waste bin and empty it of used filters. Depending on the processing volume of your laboratory, the filter waste bin may require more or less frequent emptying. Used filters may be disposed of as regular waste.

If desired, the waste bin may be wiped down with soap and water, or a 10% bleach solution but be sure to allow it to dry thoroughly before re-use.

Return the waste bin to the location it was originally in, making sure it is positioned to receive filters from the waste chute directly above it.

The slide waste bin is in the same compartment, to the left of the filter waste bin. (See Figure 8-8.) The liquid waste bottle may be in front of it, and it can be moved out of the way to access the slide waste bin. Remove the waste bin and dispose of slides in an appropriately labeled and enclosed Sharps container.

If desired, the slide waste bin may be wiped down with soap and water, or a 10% bleach solution but be sure to allow it to dry thoroughly before re-use.

Return the waste bin to its location and make sure the liquid waste bottle has been returned, as well.

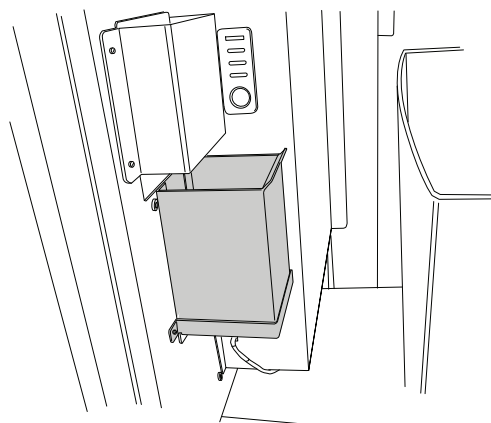

Figure 8-8 Slide Waste Bin

SECTION
C

EMPTY THE WASTE BOTTLE

Waste resulting from sample processing is routed to and stored in the waste bottle.

The instrument senses when the waste bottle is full and displays a message to empty the waste (see Figure 8-10). Or the waste may be emptied during routine maintenance of the instrument.

The waste bottle is located inside the waste cabinet - the door on the right of the AutoLoader cart.

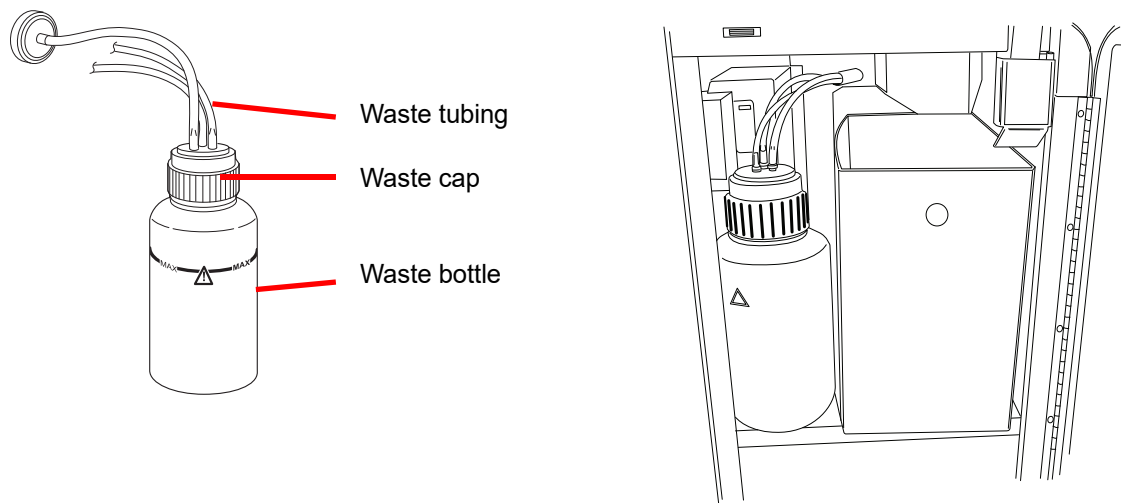

Figure 8-9 Waste Bottle and Waste Bottle Location

Emptying the Waste Bottle

From the Admin Options screen, press the **Empty Liquid Waste** button. Then touch the **Continue** button to allow the system to vent the waste bottle, so that the cap can easily be removed.

8

MAINTENANCE

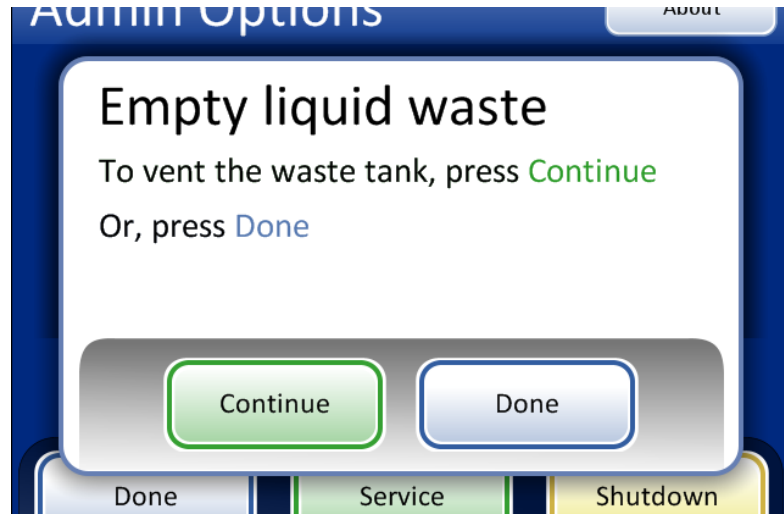

Figure 8-10 Empty Liquid Waste Button and Message

The system can be heard to vent, which depressurizes the waste bottle. It takes about 10 seconds.

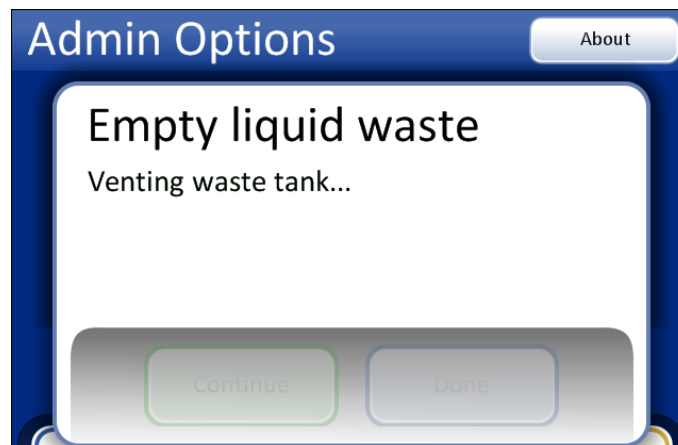

Figure 8-11 Venting the Waste Bottle

A message prompts for the operator to dispose of the waste according to the instructions in this manual. Figure 8-12.

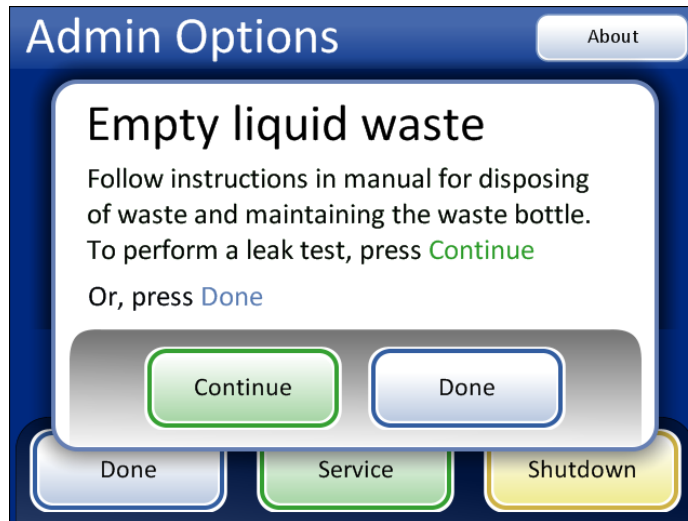

Figure 8-12 Empty and Maintain the Waste Bottle

CAUTION: At no time should bleach be present in the waste bottle while it is connected to the ThinPrep 5000 processor.

6. To remove the waste cap, rotate the waste cap with one hand while holding the waste bottle in place with the other hand.
 - If the waste tubing becomes dislodged from the waste cap during this process, reconnect the tubing before continuing.

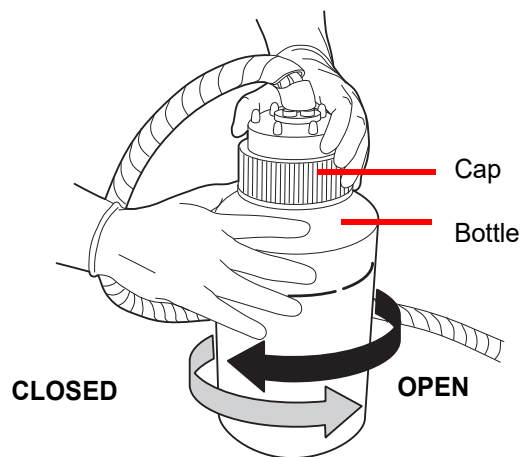

Figure 8-13 Opening/Closing the Waste Bottle

WARNING:
 Hazardous Waste
 Toxic Mixture
 Flammable Liquid and Vapor

8

MAINTENANCE

7. Place the transport cover onto the waste bottle for transporting to the waste disposal area.
8. Dispose of the liquid waste from the waste bottle according to your laboratory guidelines.
9. Before reattachment, inspect the O-ring seal on the inside of the waste cap for debris.
See Figure 8-14.
 - If debris is present, clean the seal with water using a lint-free wipe.
 - Apply a thin layer of vacuum grease to the O-ring.

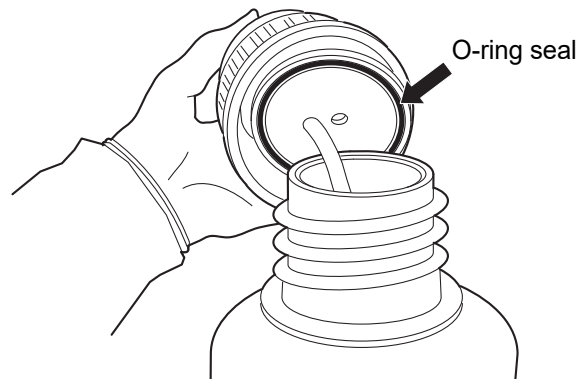

Figure 8-14 Inspect Waste Bottle O-Ring Seal

10. Return the waste bottle back to its original location and retighten the waste cap onto the bottle.
 - Verify that the waste cap is firmly tightened and confirm that the waste tubing is not pinched or twisted.

Press the **Next** button to perform a leak test. This repressurizes the waste bottle and checks that the system can hold pressure. It also measures the fluid level to verify that the waste bottle has been emptied. See Figure 8-15.

Note: The leak test **MUST** be run after emptying the bottle.



Figure 8-15 Waste System Leak Test

Press the **Done** button when complete.

Waste Bottle Connection

The waste bottle will be connected to the system at the time the instrument is installed. However, if the waste bottle and the tubing harness should be removed entirely (for overall replacement, replacement of the waste filter, cleaning, etc.) the following steps describe connecting the tubing correctly.

1. The waste bottle is located inside the waste cabinet door of the AutoLoader cart. If for some reason, the waste bottle is relocated outside of the cabinet, the waste bottle should be placed at the same height or below the ThinPrep 5000 processor. Do not place the waste bottle above the instrument.
2. Ensure that the waste bottle cap is tightly secured. The waste bottle must rest in an upright position. Do not allow the waste bottle to lay on its side.
3. Locate the three waste bottle connections at the rear of the ThinPrep 5000 processor. See Figure 8-16. Ensure that the buttons of the connectors are in the down/inward position.

8

MAINTENANCE

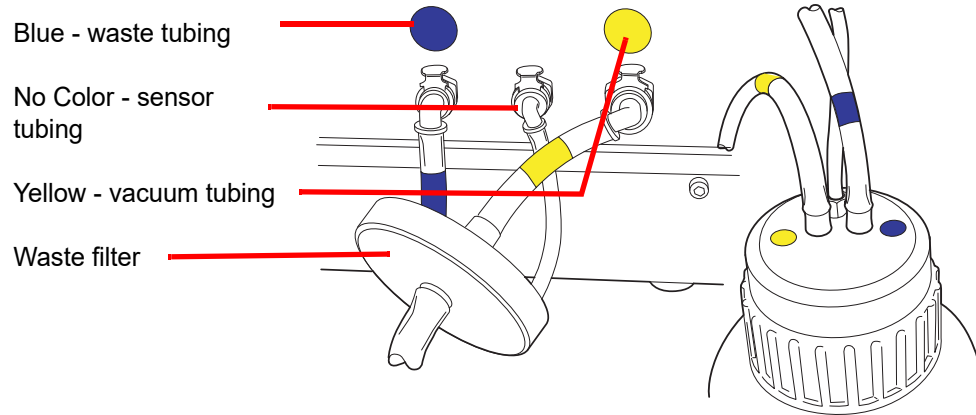

Figure 8-16 Waste Bottle Tubing Connections

4. Connect the color-coded waste tubing connectors to the corresponding connectors located in the rear of the instrument. When the proper connection has been established, the buttons on the connectors pop up/outward with a click sound. The L-shaped connector should be pointed downward.
 - Yellow = vacuum
 - Blue = waste
 - No color = pressure sensor

CAUTION: Do not mismatch tubing connections. This may result in damage to your processor.

SECTION D

CLEAN THE TOUCH SCREEN

As needed, clean the user interface touch screen with a lightly dampened lint-free cloth. From the Admin Options screen, press the **Clean Screen** button, Figure 8-17.

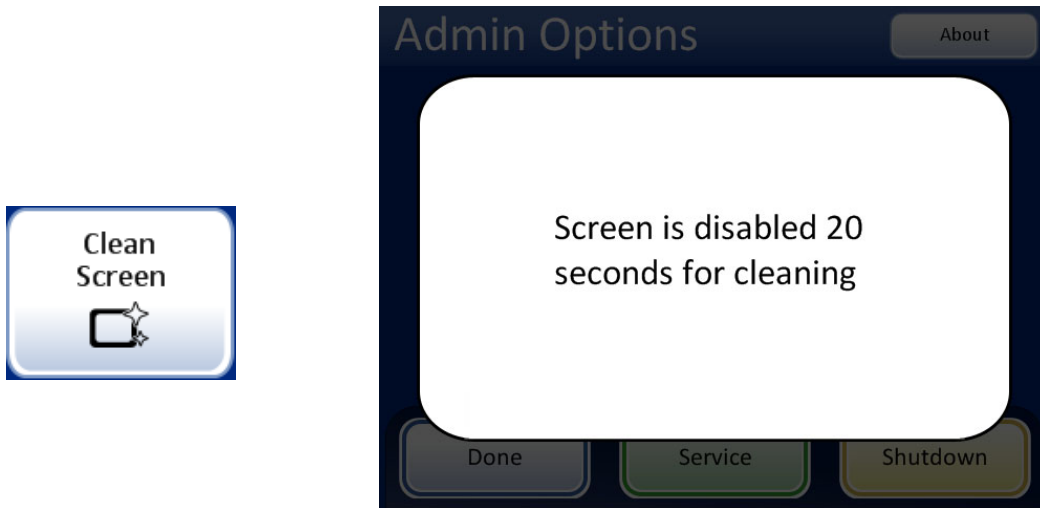

Figure 8-17 Touch Screen Disabled for Cleaning

The system disables the touch screen for 20 seconds so that the screen may be cleaned without inadvertently activating buttons or having to power off the instrument.

**SECTION
E**

CLEAN INPUT CAROUSEL AND DUST COVER

Input Carousel

As needed, clean the input carousel by wiping it down with soap and water. Allow it to dry thoroughly before using it.

Dust Cover

Wipe down the carousel dust cover with a clean cloth and soap and water.

8

MAINTENANCE

SECTION F

CHANGE ABSORBENT PADS

There are two absorbent pads in the processing compartment of the instrument that absorb drips that may result from processing. One is located at the base of the filter plug, and the other is on the top of the evaporative cover over the fixative bath carousel. See Figure 8-18.

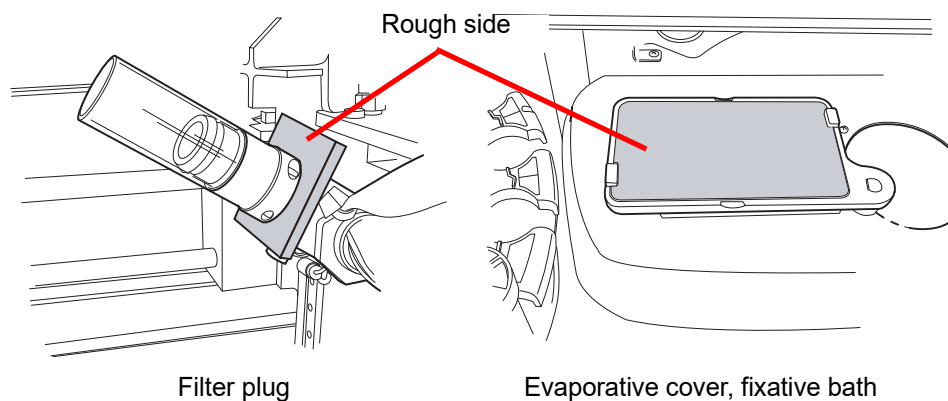

Figure 8-18 Absorbent Pads

Use the Clean System feature to help move instrument mechanisms out of the way. See “Clean System” on page 8.3.

Replace the pads once a year, or as desired. The pads can be disposed of as regular waste, unless they are dripping wet, then dispose of as hazardous waste.

When the pads are replaced, notice that one side is rough and absorbent and one side is smooth and finished. The rough side should face outward to catch any drips.

Refer to Ordering Information for ordering pads.

On a more frequent basis if desired, the pads can be washed and returned to the instrument. Clean with soap and water. Or soak in a diluted bleach rinse followed by a 70% alcohol rinse.

**SECTION
G**

CHANGE FUME EXTRACTOR FILTERS

The fume extractor for the laser etcher has a HEPA filter and a carbon filter to capture particulate matter and gas and odor. The fume extraction cabin is located inside the waste cabinet door. (See Figure 8-20.)

The instrument will prompt the user if the HEPA filter needs to be changed. The carbon filter may be changed on a yearly basis or more often, as desired.

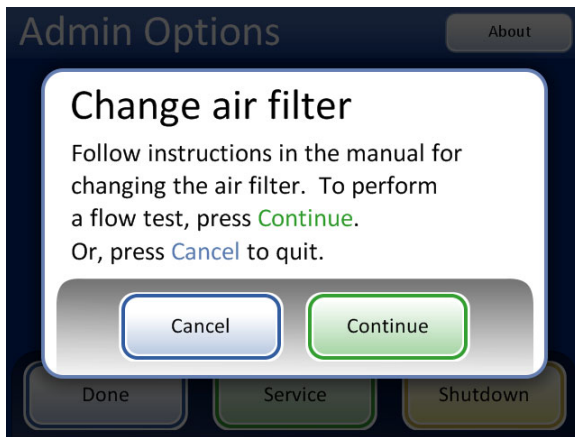

Change HEPA filter message. This message is seen when prompted by the instrument or when the **Change Air Filter** button is pressed on the Admin Options screen.



Figure 8-19 Change HEPA Filter Message

Note: Do not press the **Continue** button until the filter has been changed.

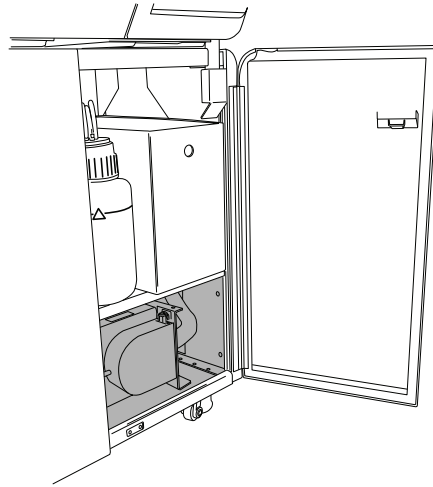

The fume extractor is located at the bottom of the waste cabinet of the AutoLoader.

Figure 8-20 Location of Fume Extractor

Open the fume extractor door by rotating the retaining latch on the left side of the door. Swing the door open.

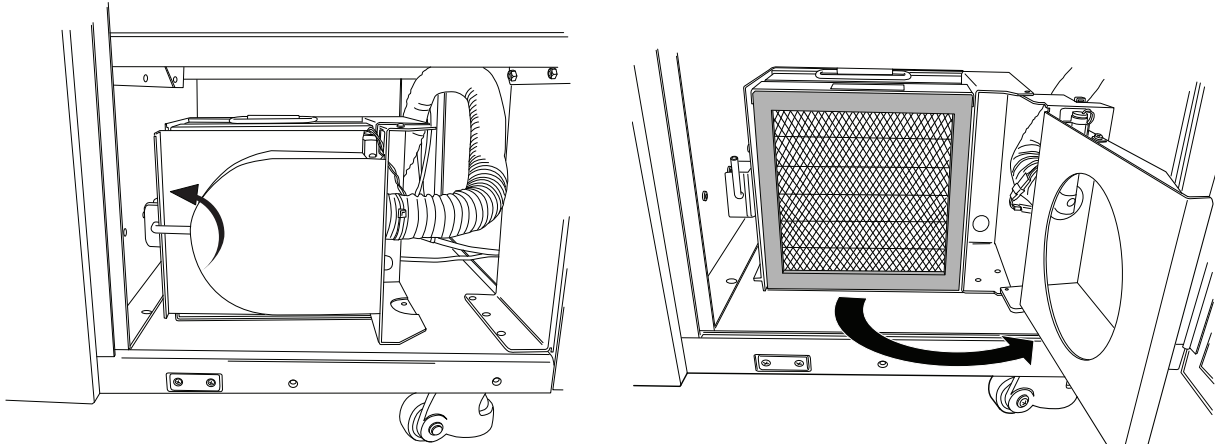

Rotate the retaining latch upward in order to open the door.

Figure 8-21 Open the Fume Extractor Door

Remove the two filters. Note that they are labeled “HEPA” and “Carbon” and they indicate the direction of air flow. (See Figure 8-22.) Remove each filter. The carbon filter may be disposed of in your laboratory refuse. Dispose of the HEPA filter according to your state guidelines.

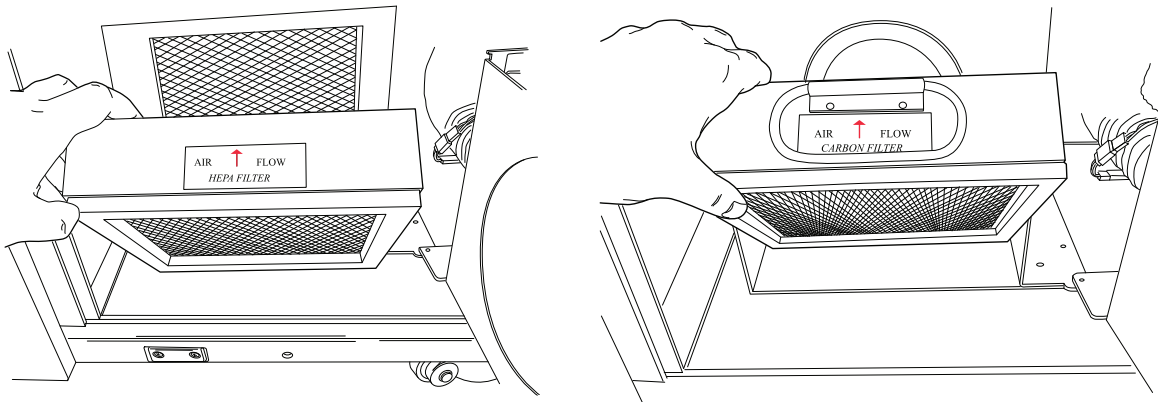

Figure 8-22 Remove the HEPA and Carbon Filters

The floor of the filter cabin is labeled to show the order of the new filter replacement and to indicate the direction of air flow. When replacing the filters, be sure to match the arrows that indicate direction of air flow.

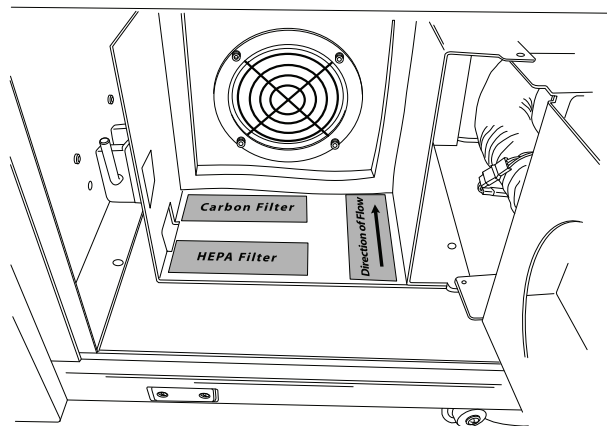

Figure 8-23 Fume Extractor Filter Labels

Replace the filters. Close the door to the cabin and return the retaining latch to the closed position.

From the message screen on the user interface, press the **Continue** button to conduct an air flow test. This determines that the filter is positioned correctly and is not clogged by measuring that an adequate volume of air is moving across the filter. This test takes a few seconds.

8

MAINTENANCE

SECTION H

REMOVE AND CLEAN DRIP TRAYS

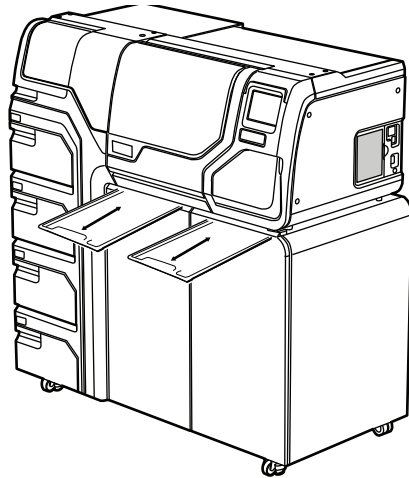

Figure 8-24 Drip Trays

Two plastic drip trays are located on the underside of the processor compartment. They slide all the way out for inspection and cleaning.

Wash them down with soap and water. Allow them to dry thoroughly before returning them to the processor.

SECTION I

REPLACING THE USER ACCESSIBLE FUSES

Processor fuses

WARNING: Instrument Fusing.

There are two user accessible fuses located on the rear of the processor, just above the power cord module (Figure 8-25). If the instrument fails to operate, the fuses can be replaced as outlined below. Hologic Field Service can replace the fuses as needed.

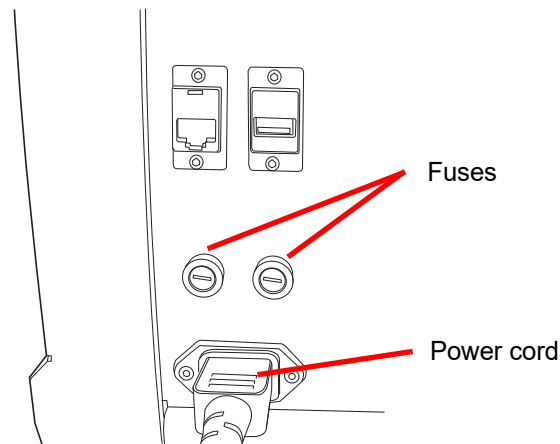

Figure 8-25 Location of User Accessible Fuses

1. Make sure the power switch is in the OFF position.
2. Remove the power cord from the receptacle on the instrument.
3. Using a small, flat-head screwdriver, turn each fuse head counterclockwise 1/4 turn. The fuse, which is slightly recessed in the fuse holder when latched, will pop forward slightly when it has been turned far enough to be released from the catches.
4. Pull the fuses out of the receptacles. They may be discarded as regular waste.
5. Insert two new 15A/250V 3AB SLO-BLO fuses (P/N 53247-015).

Note: Hold the fuse by the metal ends.

6. Using the flat-head screwdriver, press each fuse cover into the receptacle while turning clockwise 1/4 turn. The fuse can be felt to engage with the catches and it will be slightly recessed into the fuse holder.
7. Reattach the power cord to the instrument.
8. Turn the instrument power switch ON.

If the instrument fails to operate, contact Hologic Technical Support.

AutoLoader fuses

WARNING: Instrument Fusing.

There are also two user-accessible fuses located on the rear of the AutoLoader, just above the AutoLoader power cord module (Figure 8-25). If the AutoLoader fails to operate, the fuses can be replaced as outlined below. Hologic Field Service can replace the fuses as needed.

1. Shut down the processor. Make sure the power switch is in the "off" position.
2. Remove the power cord from the receptacle on the processor.

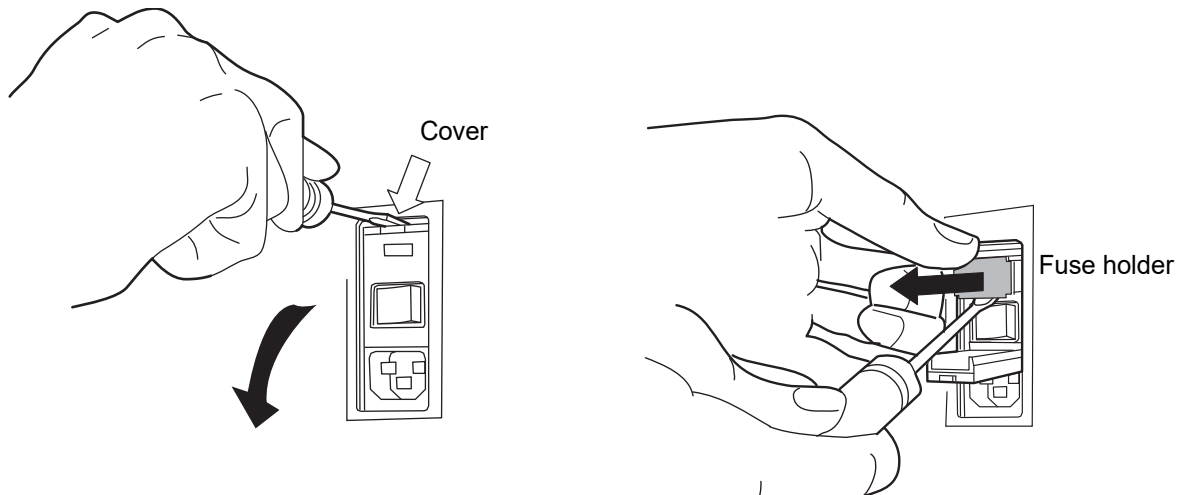

Figure 8-26 Remove the fuse holder

3. Using a small, flat-head screwdriver, pry the cover near the power cord receptacle open. Pry out the fuse holder.
4. Pull the two fuses out of the receptacles on the holder. They may be discarded as regular waste.
5. Insert two new 6.3A/250V 5x20 mm fuses (P/N 50077-021).

Note: Hold the fuse by the metal ends.

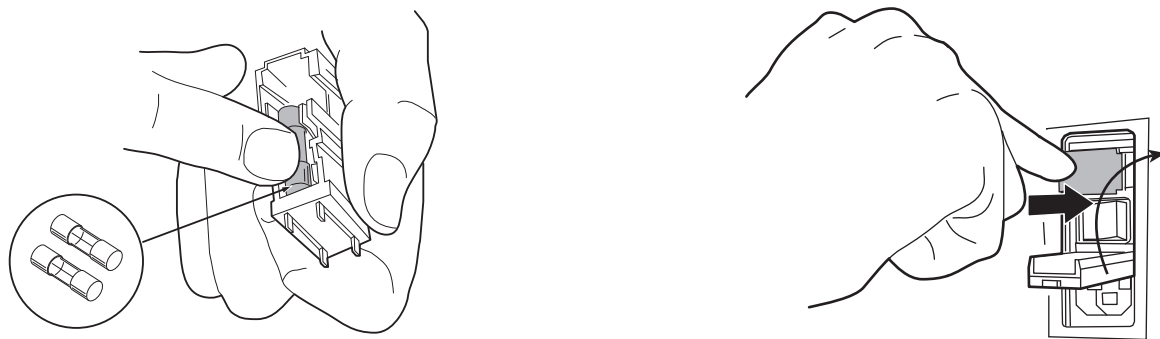

Figure 8-27 Insert new fuses and replace fuse holder

6. Push the fuse holder back into the AutoLoader. Push the cover back into position.
7. Reattach the power cord to the AutoLoader.
8. Turn the processor power switch on.

If the instrument fails to operate, contact Hologic Technical Support



MAINTENANCE

This page intentionally left blank.

Chapter Nine

Troubleshooting

SECTION A

GENERAL

There are three categories of error/status that the system can generate:

- Sample Processing Errors
- User Correctable Batch Errors
- System Errors

SECTION B

SAMPLE PROCESSING ERRORS

At the conclusion of batch processing, sample errors are reported on the batch report. Sample errors occur when a sample vial is being processed. They are “sample specific” and usually only affect the sample vial being processed. A slide is not made and the operator must resolve the event and process the vial in another batch.

The error only appears on the batch report. It will not be recorded in the error log.

When a sample processing error occurs:

- If a vial has been picked up, the system will return it to the input carousel.
- If a filter has been picked up, it will be disposed of.
- If a slide has been picked up but not used, it will be returned to the input carousel.



Table 9.1: Sample Processing Errors

Error	Description	Possible Cause	Corrective Action
<p>5000 - Sample Is Dilute</p>	<p>This error message indicates the entire sample was utilized in preparing the slide. This message is only a notification; the slide is processed and may be adequate.</p>	<p>This is usually caused by a low concentration of cells in the sample. This message usually indicates a problem with the sample that was collected, rather than an issue with the instrument and its mechanisms.</p> <p>Note: A slide is made from the sample vial.</p>	<p>Gyn slides - If the slide is satisfactory for screening purposes, no further action is necessary. If the slide is inadequate, follow laboratory procedure for reporting unsatisfactory specimens.</p> <p>Non-gyn slides - If there is additional sample material available, make another slide with more cells if possible.</p>
<p>5001 - Sample Too Dense</p>	<p>The sample is too dense for the instrument to make a satisfactory slide.</p>	<p>The sample is too dense for the instrument to make a satisfactory slide.</p>	<p>This is for Non-gyn samples only. Shake or vortex sample for 8–12 seconds. Then dilute sample by 20:1. Place 1 mL of sample into a new PreservCyt Solution vial and process again.</p>
<p>5002 - Failed to Uncap Vial</p>	<p>The vial could not be uncapped. The sample was not processed and a slide was not made.</p>	<p>Vial cap is screwed on too tight. Mechanical failure prevented uncapping of the vial</p> <p>Damaged vial cap</p>	<p>Check the vial and cap. Make sure the plastic over wrap has been removed from the vial. Loosen and retighten the cap and process again.</p> <p>Replace with new vial cap.</p>

Table 9.1: Sample Processing Errors

Error	Description	Possible Cause	Corrective Action
5003 - Failed to Read Vial ID	The barcode on the vial could not be read or is an invalid format. The sample was not processed and a slide was not made.	<p>The barcode label is missing, damaged, or printed at poor quality.</p> <p>The barcode label is not applied to the vial properly.</p> <p>Wrong type of barcode was applied.</p> <p>Failure of the barcode reader</p>	<p>Examine the barcode label to see if it is missing, damaged, or printed poorly. Replace, if necessary (refer to “Adhering Vial Labels” on page 7.3).</p> <p>Examine the barcode label and ensure it is the correct format (refer to “Configure Barcodes” on page 6.42).</p> <p>Make sure nothing is blocking the vial barcode reading station (see Figure 8-3).</p> <p>Contact Technical Support if the problem persists.</p>
5004 - Failed to Read Slide ID	The slide ID could not be read or is an invalid format. The sample was not processed and a slide was not made.	<p>No slide present</p> <p>Slide present with missing or damaged label. In AutoLoader mode, this may be due to bad laser etching.</p> <p>System setting for OCR/Barcode label conflicts with the type of label on the slide.</p> <p>Mechanical misalignment or failure of the reader</p>	<p>Make sure a slide is present and is labeled correctly. (Refer to “Configure Barcodes” on page 6.42.)</p> <p>Check the slide label setting on the instrument to see if it matches the type of slide label being used. Refer to “Configure Barcodes” on page 6.42.</p> <p>Make sure nothing is blocking the slide ID reader (see Figure 8-3).</p> <p>Contact Technical Support if the problem persists.</p>



9 TROUBLESHOOTING

Table 9.1: Sample Processing Errors

Error	Description	Possible Cause	Corrective Action
5005 - Failed to Tighten Cap	The vial could not be tightened prior to the dispersion step.	<p>Damaged vial cap.</p> <p>Mechanical failure prevented tightening of the cap.</p>	Check the vial and cap. Make sure the cap does not have broken cap ridges. Replace a damaged vial cap with a new vial cap. With an undamaged vial cap, loosen and retighten the cap and process again.
5006 - Slide Not Found (small batch mode only)	<p>A slide is not sensed in the slide gripper when attempting pickup. The sample is not processed and no slide is made.</p> <p>Note:This error is only valid when using an Advanced sequence process - 'Disable Slide ID Match' or 'Multiple Slides per Vial'.</p>	<p>Slide not present in carousel slot</p> <p>Slide leaning out of position in carousel slot</p> <p>Mechanical misalignment or failure of the slide gripper</p>	<p>Confirm that a slide is present in the carousel, and that it is in position.</p> <p>Attempt to reprocess the sample. Contact Technical Support if the error persists.</p>
5007 - Invalid Vial ID	Barcode on the vial is not a valid format.	<p>Barcode data on the vial is too long or too short.</p> <p>Vial ID is the wrong format to become an OCR slide ID.</p> <p>The barcode configuration for the vial ID does not match the vial IDs used in your laboratory.</p>	<p>Check and correct the Vial ID barcode configuration on the instrument.</p> <p>Verify that the Slide Label Design is set to match the format used in the lab.</p> <p>Use and pass the Test Settings test prior to running samples.</p> <p>Refer to "Configure Barcodes" on page 6.42.</p>

Table 9.1: Sample Processing Errors

Error	Description	Possible Cause	Corrective Action
5008 - Invalid Slide ID	Barcode on the slide is not a valid format.	Barcode data on the slide is too long or too short. The barcode configuration for slide ID does not match the slide IDs used in your laboratory.	Check and correct the Slide ID barcode configuration on the instrument. Verify that the Slide Label Design is set to match the format used in the lab. Use and pass the Test Settings test prior to running samples. Refer to “Configure Barcodes” on page 6.42.
5009 - Duplicate Vial ID	A sample vial has the same ID as one that has already been processed in the batch. The vial with the duplicate ID will not be processed. Note: In AutoLoader mode, one vial tray is one batch; in Small Batch mode, one carousel is one batch.	Multiple vials were labeled with the same ID number. The vial ID barcode configuration is not set up to correctly identify the section of the vial label that is the accession ID.	Check the sample IDs and confirm that they are duplicates. A slide was only made from the first vial. The patient information must be checked and reconciled for both vials. Relabel the second vial and reprocess. Correct the vial ID barcode configuration on the instrument. Refer to “Configure Barcodes” on page 6.42.



9 TROUBLESHOOTING

Table 9.1: Sample Processing Errors

Error	Description	Possible Cause	Corrective Action
<p>5010 - Insufficient Fluid or Filter Not Present</p>	<p>The vial does not contain enough fluid to process properly. (17 mL is the minimum required volume.) The sample was not processed and a slide was not made.</p>	<p>Filter not present</p> <p>The vial leaked.</p> <p>Pneumatic system error</p> <p>Preparation error resulting in not enough fluid</p> <p>Note: See “OPTIONAL INSTRUCTIONS FOR ANCILLARY TESTING” on page 7.35 for aliquot removal instructions.</p> <p>Note: This check is not performed when using multiple slides per vial sequence processing.</p>	<p>Make sure a filter is present and loaded correctly, with the open end up.</p> <p>Examine the vial to make sure it is not leaking. Place sample into another vial if it is damaged.</p> <p>Check the fluid level in the vial. Add PreservCyt Solution if the level is below the frosted line on the vial. Do not overfill beyond the frosted line. Reprocess the sample.</p>
<p>5011 - Excessive Fluid</p>	<p>When introducing the filter into the vial, the system detects the fluid level too early. (21 mL is the maximum allowed volume.) There is too much fluid in the vial. The sample was not processed and a slide was not made.</p>	<p>Too much fluid in the vial.</p> <p>Pneumatic system error.</p>	<p>Examine the vial and see if the level of the fluid is above the frosted line on the vial. If it is necessary to reduce the sample volume to between 17 mL and 21 mL, save any excess fluid in an appropriate container. Reprocess the vial.</p>

Table 9.1: Sample Processing Errors

Error	Description	Possible Cause	Corrective Action
5012 - Vial/Slide ID Mismatch (small batch mode only)	The vial and slide IDs were both successfully read, but did not match. The sample was not processed and no slide was made.	<p>Slides placed in wrong carousel slot</p> <p>Incorrect labeling of slides or vials</p> <p>The slide ID barcode configuration is not set up to correctly identify the section of the vial label that is the accession ID for the sample.</p>	<p>Examine the vial and slide IDs to confirm they do not match.</p> <p>See if the slide has been filed in the wrong slot on the carousel. (Look at subsequent IDs, in case the mistake was perpetuated within the carousel.)</p> <p>Reconcile the patient information with the correct ID. Relabel, if necessary.</p> <p>Correct the slide ID barcode configuration on the instrument. Refer to “Configure slide ID for pre-labeled slides” on page 6.57.</p>
5013 - End of Vial or Filter Not Present in Multiple Slides per Vial (small batch mode only)	The entire sample was consumed during the advanced process sequence ‘Multiple Slides per Vial’. This error only occurs during Multiple Slides per Vial mode, which does not check for fluid level or dilute sample. The slide was processed, but should be checked for adequacy.	<p>Filter not present</p> <p>All fluid in the vial was consumed.</p> <p>Pneumatic system failure</p>	<p>Make sure a filter is present.</p> <p>If Multiple Slides per Vial mode is being used, there is not enough sample to process the desired number of slides.</p> <p>Examine the vial to see if it is empty.</p>



TROUBLESHOOTING

Table 9.1: Sample Processing Errors

Error	Description	Possible Cause	Corrective Action
<p>5014 - IDs on Vial and Slide Could Not Be Read (small batch mode only)</p>	<p>Failure to read both vial and slide IDs. The sample was not processed and no slide was made.</p>	<p>Labels not present, damaged, or printed at poor quality Mechanical failure of ID readers.</p>	<p>Examine the vial barcode label to see if it is missing, damaged, or printed poorly. Replace, if necessary (refer to “Adhering Vial Labels” on page 7.3). Make sure a slide is present and is labeled correctly. (Refer to “Adhering Vial Labels” on page 7.3.)</p> <p>Examine the vial and slide labels, and ensure they are the correct format (refer to “Slide barcode label format” on page 7.22).</p> <p>Make sure nothing is blocking the vial barcode reading station or the slide reader (see Figure 8-3).</p> <p>Contact Technical Support if the problem persists.</p>

Table 9.1: Sample Processing Errors

Error	Description	Possible Cause	Corrective Action
5015 - Duplicate Slide ID	Multiple slides were labeled with the same ID number in the batch. The vial with the duplicate ID will not be processed.	In Small Batch Mode, multiple slides were labeled with the same ID number. In AutoLoader mode, the ID for a slide was generated but not etched because the slide ID would have the same ID number as another slide ID. The vial ID and/or slide ID barcode configuration and/or the slide label design is/are not set up to correctly identify the section of the vial label that is the accession ID and etch it on the slide.	Check the sample IDs and confirm that they are duplicates. A slide was only made from the first vial. The patient information must be checked and reconciled for both vials. In Small Batch mode, relabel the second slide and reprocess. In AutoLoader mode, check and correct the Label Design. Correct the slide ID barcode configuration on the instrument. Refer to "Configure Slide ID" on page 6.50.
5016 - Sample Error During Processing	Positive tank error or other error during cell transfer. This message is only a notification; the slide is processed and may be adequate.	The filter might be punctured or defective. The system has a pressure leak.	Gyn slides - If the slide is satisfactory for screening purposes, no further action is necessary. If the slide is inadequate, follow laboratory procedure for reporting unsatisfactory specimens. Non-gyn slides - If there is additional sample material available, make another slide with more cells if possible. If the error persists, contact Technical Support.
5017 - Obstruction in Vial	Filter meets resistance when moving into the vial.	Possible object left in vial such as collection device	Examine the vial to see if there is a foreign object in it.



TROUBLESHOOTING

Table 9.1: Sample Processing Errors

Error	Description	Possible Cause	Corrective Action
5018 - Failed to Place Vial in Dispersion Cup	The vial could not be inserted properly into the dispersion well. The sample was not processed and a slide was not made.	<p>Possible obstruction in the dispersion well.</p> <p>Possible obstruction on the bottom or side of the vial, such as too many labels.</p> <p>Misshaped vial cap on the vial.</p>	<p>Check the dispersion well and remove the obstruction.</p> <p>Re-label the vial. Reprocess the vial.</p>
5019 - Failed to Remove Vial from Tray	The mechanism failed to remove a vial from the vial tray	<p>Too many labels applied to the vial, or labels applied such that the vial is stuck in the tray.</p> <p>Possible malfunction of the mechanism.</p>	<p>Re-label the vial. Reprocess the vial.</p> <p>If the error persists, contact Technical Support</p>
5100 - Processing Error	-	-	If the error persists, contact Technical Support.
5101 - Processing Error	-	-	If the error persists, contact Technical Support.
5102 - Processing Error	-	-	If the error persists, contact Technical Support.
5104 - Processing Error	-	-	If the error persists, contact Technical Support.
5105 - Pneumatics Error	-	-	If the error persists, contact Technical Support.

Table 9.1: Sample Processing Errors

Error	Description	Possible Cause	Corrective Action
5106 - Processing Error (AutoLoader mode only)	A processor timeout error, usually caused by a leak or other pneumatic error condition. The sample was not processed and no slide was made.	<p>Leak around the filter plug assembly</p> <p>Punctured filter membrane</p> <p>Occluded filter membrane</p> <p>Sensor line pinched or open</p> <p>Pneumatic error</p>	<p>Check to see that nothing is interfering with the filter plug and that the filters are loaded correctly.</p> <p>Check to see if the sample vial contains a portion of the collection device or other foreign matter that might puncture the filter.</p> <p>Contact Technical Support if the problem persists.</p>
5200 - Failed to Access LIS file (AutoLoader mode only)	Permission or location issue with the LIS (laboratory information system) file.	The NAS (network attached storage) is not plugged in. The file has not been put there from the user's database.	Verify the NAS is connected. Verify that the file with this information was put there.
5201 - Failed to Read LIS file (AutoLoader mode only)	Unable to access the LIS file.	The NAS (network attached storage) is not plugged in. The file has not been put there from the user's database.	Verify the NAS is connected. Verify that the file with this information was put there.
5203 - Barcode Width Exceeds Slide Label Width (AutoLoader mode only)	-	Barcode exceeds slide label width. The barcode is too long for slide label.	Refer to "Vial Barcode Label Format" on page 7.3. Only when LIS error policy is enabled.
5204 - Invalid Character in Barcode String (AutoLoader mode only)	-	Invalid character in barcode string.	Refer to characters supported by the ThinPrep 5000 processor on page 6.39. Only when LIS error policy is enabled.
5205 - Invalid Barcode Length (AutoLoader mode only)	-	Invalid barcode string length.	Refer to barcode label format on page 6.39. Only when LIS error policy is enabled.

9

TROUBLESHOOTING

SECTION C

BATCH PROCESSING ERRORS

Batch processing errors are errors that the system is capable of recovering from with user intervention. The errors occur during the processing of a batch. When the system encounters a batch error condition, the batch halts (terminates, or pauses, depending on the cause) and signals the error via a message on the user interface and by sounding the audible alarm, if it is enabled. Some errors may be detected at the start of a batch, which will stop it from commencing.

The error only appears on the batch report. It will not be recorded in the Error Log.

Table 9.2: Batch Processing Errors

Error	Description	Possible Cause	Corrective Action
4000 - No Empty Tubs	No empty fixative baths are present. Baths containing one or more slides are present. The batch will not start.	An empty fixative bath was not loaded. Sensor failure in detecting empty tubs A tub was loaded with one or more slides in it.	At least one bath with no slides must be present for a batch to begin. If at least one bath is present and this error occurs, contact Technical Support.
4001 - No Vial Detected (Multiple Slides per Vial in small batch mode)	The system did not detect a vial in slot 1 of the carousel when starting a Multiple Slides per Vial batch. The batch will not start.	Vial not loaded in slot 1 of the carousel Sensor malfunction	Refer to "Select the Sample Processing Sequence" on page 7.26 for running the multiple slides per vial sequence. If at least one vial is present and this error occurs, contact Technical Support.
4002 - Extra Vials Detected (Multiple Slides per Vial in small batch mode)	The system detected more than one vial when starting a Multiple Slides per Vial batch. The batch will not start.	More than one vial is in the carousel. Sensor malfunction	Make sure there is a vial in slot 1 of the carousel. No other vials may be loaded into the carousel.

Table 9.2: Batch Processing Errors

Error	Description	Possible Cause	Corrective Action
4004 - Extra Vials Detected (Disable Slide ID Match in small batch mode)	More than one vial was detected when the system started a batch in Disable Slide ID Match mode. The batch will not start.	More than one vial is in the carousel. Sensor malfunction	Refer to “Select the Sample Processing Sequence” on page 7.26 for running the Disable Slide ID Match sequence.
4005 - No Vials Found (small batch mode)	No vials were detected while starting a batch. There must be at least one vial to start a batch.	No vials are in the carousel. Sensor malfunction	At least one vial must be in the carousel to start a batch. If at least one vial is present and this error occurs, contact Technical Support.
4006 - Slide Not Detected at Drop Off (small batch mode)	The system could not detect the presence of a slide in the fixative bath after putting one there. The batch terminates. Note: This error only occurs if the first slide deposited into the bath is not detected.	Fixative bath did not have a staining rack in it to hold the slide. Failure of the slide sensor	Inspect the fixative bath to see if a slide was deposited into it and if there is a staining rack to hold it. Add a staining rack if it is not present. Contact Technical Support if a staining rack and slide are present.
4007 - No Slide Detected in First Position (Multiple Slides per Vial in small batch mode)	A slide was not detected at position 1 of the carousel when the batch was beginning. The batch will not start. Note: Only the first slide is detected in this mode. The subsequent number of samples processed out of the vial is not counted. The process sequence is over when no more filters and slides are detected, or when the vial is too empty for the system to process another slide.	A slide was not placed into slot 1 of the carousel prior to starting the batch. Sensor failure	Place a slide into slot 1 of the carousel. If a slide is in position 1 and this error occurs, contact Technical Support.



TROUBLESHOOTING

Table 9.2: Batch Processing Errors

Error	Description	Possible Cause	Corrective Action
4008 - Vial Not Successfully Uncapped (Multiple Slides per Vial in small batch mode)	Failed to uncap the vial during the batch Note: This is a batch error in Multiple Slides per Vial mode since there is only one vial used in this process sequence. In normal processing, this is a sample error (5002) since the system can go on to the next sample.	Vial cap is screwed on too tight. Mechanical failure prevented uncapping of the vial.	Check the vial and cap. Make sure the plastic over wrap has been removed from the vial. Loosen and retighten the cap and process again. If the error persists, contact Technical Support.
4009 - Positive Tank Pressure	Positive tank failed to reach transfer pressure. (Pressure within the filter required for cell transfer from the filter membrane to the microscope slide did not occur.)	The filter might be punctured or defective. The system has a pressure leak.	Check that the filters are not defective. Reprocess the vial. If the error persists, contact Technical Support.
4010 - Bad Fluid Level (Multiple Slides per Vial in small batch mode)	Fluid level is incorrect (MSVP mode).	The system detected that the initial fluid level in the vial was more than the maximum of 21 mL or below the minimum of 17 mL.	Check that the fluid level in the sample vial is between 17 mL and 21 mL when initiating processing in the multiple slides per vial mode.
4011 - Batch Processing Error	The system has encountered a positive pressure problem during cell transfer. A slide was not made.	The filter might be punctured or defective. The system has a pressure leak.	Check that the filters are not defective. Reprocess the vial. If the error persists, contact Technical Support.

Table 9.2: Batch Processing Errors

Error	Description	Possible Cause	Corrective Action
4012 - Empty Liquid Waste Tank	The liquid waste tank is full and should be emptied. A batch cannot be started until this has been performed.	The system detected the waste tank was full via a pressure measurement.	Empty the liquid waste tank (refer to page 8.9). The leak test MUST be run after emptying the waste tank. If the message occurs and the tank is empty, run the leak test. If the leak test passes, attempt to run a batch. If the leak test fails, contact Technical Support.
4013 - Carousel Not Empty (AutoLoader mode only)	The carousel is not empty during the start of AutoLoader processing.	A vial, filter, slide or any combination is present in the carousel.	Clear the carousel of any media and start again.
4014 - Door interlocks are preventing slide marking. Doors must be closed to mark slides. (AutoLoader mode only)	The system sensed the slide door open while processing. Processing cannot proceed with doors open.	A door was forced open during processing. A door sensor is faulty.	Close the slide door if it is open. Contact Technical Support if the door is closed and the error recurs.
4015 - No Carousel Slots Available (AutoLoader mode only)	Vials that have experienced a sample error will be placed into an empty carousel slot for reprocessing/reconciliation when the batch is complete. The number of sample errors in the batch has caused all available carousel positions to be used up.	Exceeded maximum number of sample errors in a batch.	Review the batch report to identify the sample errors. Reconcile the samples and reprocess in another batch.



Table 9.2: Batch Processing Errors

Error	Description	Possible Cause	Corrective Action
4050 - Invalid Vial ID (3 in a row, AutoLoader mode only)	Three consecutive occurrences of an invalid vial ID	Barcode configuration is not set correctly or the vial labels do not match the barcode configuration.	<p>Check and correct the Vial ID barcode configuration on the instrument.</p> <p>Use and pass the Test Settings test prior to running samples. Refer to “Configure Barcodes” on page 6.42.</p>
4051 - Invalid Slide ID (3 in a row, AutoLoader mode only)	Three consecutive occurrences of an invalid slide ID	<p>Barcode data on the slide is too long or too short.</p> <p>The barcode configuration for slide ID does not match the slide ID used in your laboratory.</p>	<p>Check and correct the Slide ID barcode configuration on the instrument.</p> <p>Verify that the Slide Label Design is set to match the format used in the lab.</p> <p>Use and pass the Test Settings test prior to running samples. Refer to “Configure Barcodes” on page 6.42.</p>
4052 - Failed to Read Slide ID (3 in a row, AutoLoader mode only)	Three consecutive events of failure to read a slide ID	<p>No slides present.</p> <p>Slides present with missing or damaged label.</p> <p>In AutoLoader mode, this may be due to laser not functioning properly.</p> <p>Mechanical misalignment or failure of the reader.</p>	If slides are present and labeled, contact Technical Support.
4053 - Cell Transfer Low (3 in a row, AutoLoader mode only)	Three consecutive events of failure to sip sample from a vial	Failure with the pneumatic system	Contact Technical Support.

Table 9.2: Batch Processing Errors

Error	Description	Possible Cause	Corrective Action
4054 - LIS Open (3 in a row, AutoLoader mode only)	Three consecutive events of failure to access the LIS (laboratory information system)	LIS file that was specified does not exist or the path to it is incorrect. The NAS (network attached storage) is not plugged in. The file has not been put there from the user's database.	Verify the NAS is connected. Verify that the file with this information was put there
4055 - Failed to Read LIS File (3 in a row, AutoLoader mode only)	Three consecutive events of failure to read a LIS file. (The file exists but cannot be read.)	Permissions may be incorrect on the file. The NAS (network attached storage) is not plugged in. The file has not been put there from the user's database.	Verify the NAS is connected. Verify that the file with this information was put there.
4057 - Barcode Exceeds Slide Label Width (3 in a row, AutoLoader mode only)	Three consecutive events of barcode too wide	The barcode may contain too many characters.	Refer to barcode parameters required by the system on page 6.39.
4058 - Invalid Barcode Character (3 in a row, AutoLoader mode only)	Three consecutive events of invalid character(s) in the barcode	Usage of characters not accepted by the system	Refer to the characters supported by the system on page 6.39.
4059 - Invalid Barcode Length (3 in a row, AutoLoader mode only)	Three consecutive events of barcode length being too long	Barcode string length is too long.	Refer to barcode parameters on page 6.39.

SECTION
D

SYSTEM ERRORS

System errors are errors that the ThinPrep 5000 processor with AutoLoader is not capable of recovering from without user intervention. The current batch terminates and the system attempts to create a batch report. A system error is an error that will most likely require field service assistance. A user may choose or be instructed to restart the system. The error is reported to the error log.

Clearing a System Error

When a system error has been detected, the system will usually:

- Attempt to recap the vial and attempt to deposit a slide in a fixative bath
- Move mechanisms out of the way, release the input carousel lock, unlock the doors and return to an idle state.
- Display the error message and sound the audible alarm, if enabled (see Figure 9-1.) The system attempts to recover (a minute or less).

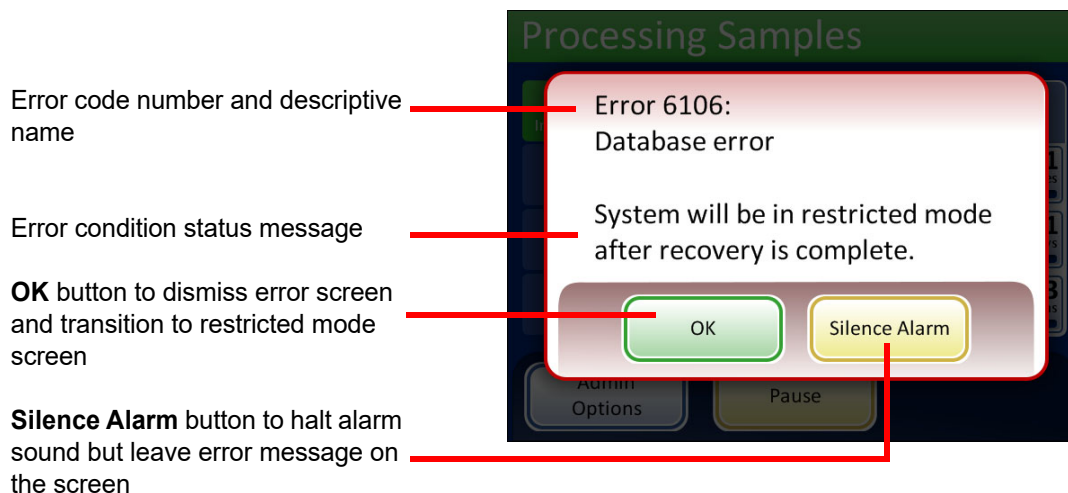

Figure 9-1 System Detected an Error

If the system cannot recover, it attempts to move the mechanisms out of the way, turns off the transport arm motors so the operator can easily move the slide and filter transport arms and releases the input carousel so that it can spin freely. The doors unlock for user access.

Restricted Mode

If the instrument cannot fully recover from an error condition, the application will transition to restricted mode. This allows the operator to access some functions, but the system cannot process samples until the error is resolved. After acknowledging the error message, the user interface

displays the **Admin Options** screen. The **Reports** button is available, where you can review or download the System Events report (which will have captured the error code). The **Service** access button is available if the system cannot recover and requires a service visit. The **Shutdown** button is available, in order to restart the instrument, which usually clears a system error.

CAUTION: Do not restart the instrument with a USB key in any of the ports.



Figure 9-2 Restricted Mode Admin Options Screen

To recover from an error requiring shutdown, press the **Shutdown** button.

Wait for the computer to turn off (wait until the touch screen interface goes blank). Then turn off the power switch on the right side of the instrument. After a few seconds of the power being fully off, turn the processor on again and let it boot up. The main screen should be displayed when the system is ready to process.

If the restricted mode screen appears, contact Technical Support.

Clear Media

For some system errors, a “Clear media” message dialog may display. This prompts the operator to check the mechanisms along the processing path to remove a filter, vial or slide that may have been left in process. The display provides buttons that will release the holding pressure on those media for removal. Each button must be pressed before the message box will close. See Figure 9-3.

If the robotic arm was holding a vial, filter or slide, the item may have been released down into the elevator shaft. It can be retrieved from the waste tray at the bottom of the shaft.

Note: The media will drop as soon as the pressure is released. Hold the item before pressing the button so it won't fall.

9

TROUBLESHOOTING



Release Vial Cap will open the fingers of the vial gripper to drop the vial cap.

Release Slide will release the slide gripper fingers to let go of the slide and release the suction vacuum of the slide holder cups at the cell transfer area.

Release Filter vents the filter plug, so that the filter may be pulled off.

Figure 9-3 Clear Media Screen

It may be difficult to view and reach the filter or vial cap. Gently slide the filter/vial transport arm to the middle of the processing area to access the media. The slide transport arm may be moved in the same way.

Release Filter

The filter plug keeps a slight pressure in the filter once it has been picked, to keep it from dropping. To remove a filter that is left on the filter plug, press the **Release Filter** button. Then gently pull the filter off.

CAUTION: Never forcibly remove a filter from the filter plug without releasing the system pressure, as damage to the instrument could occur.

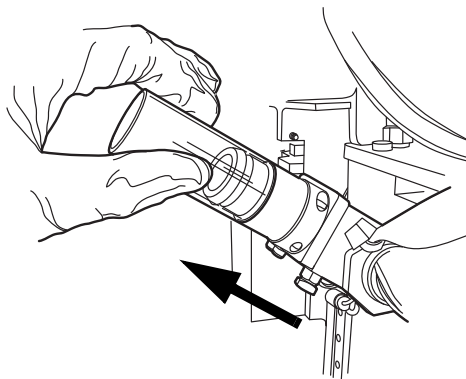

Figure 9-4 Release Filter

Release Vial Cap

The vial gripper fingers remain closed in an error condition, so that a vial will not drop. Move the vial transport arm toward the middle of the instrument and then press the **Release Vial** button to open the gripper and retrieve the vial. See Figure 9-5.

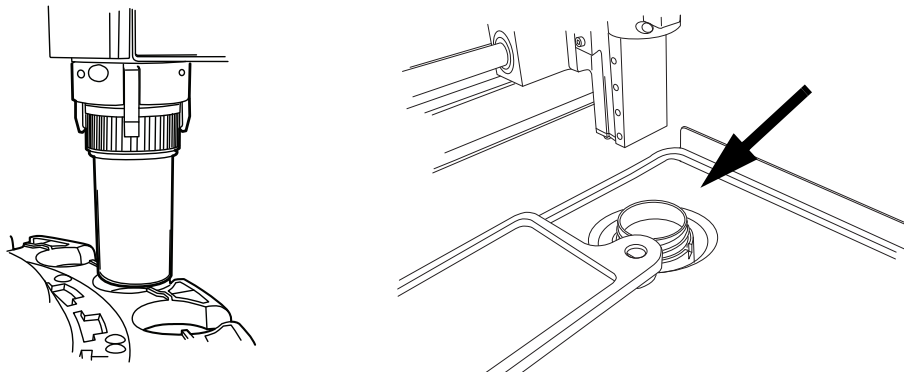

Figure 9-5 Release Vial, Check Dispersion Well

Note: Often just the vial cap is in the mechanism. Carefully check the dispersion well and retrieve the vial, if necessary. Manually recap the vial. See Figure 9-5.

Release Slide

Note: Locate where the slide is before pressing the release button.

A slide might be located in the slide gripper of the slide transport arm. The slide grippers remain closed after picking a slide until it has been handed off to the slide holder of the cell transfer area. To release the slide from the gripper, press the **Release Slide** button.

The slide may be left on the suction holders of the cell transfer area. When the **Release Slide** button is pressed, the suction vacuum is released.

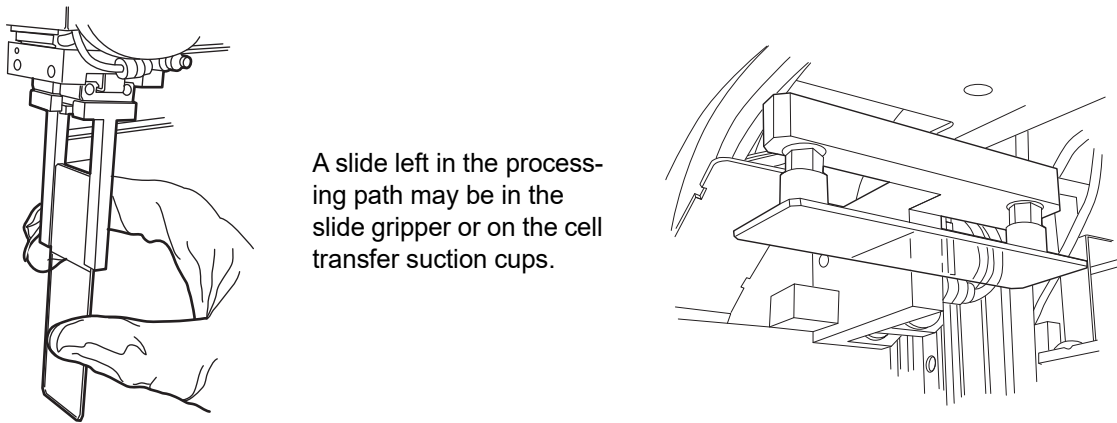

A slide left in the processing path may be in the slide gripper or on the cell transfer suction cups.

Figure 9-6 Release Slide

Media down the Elevator Shaft

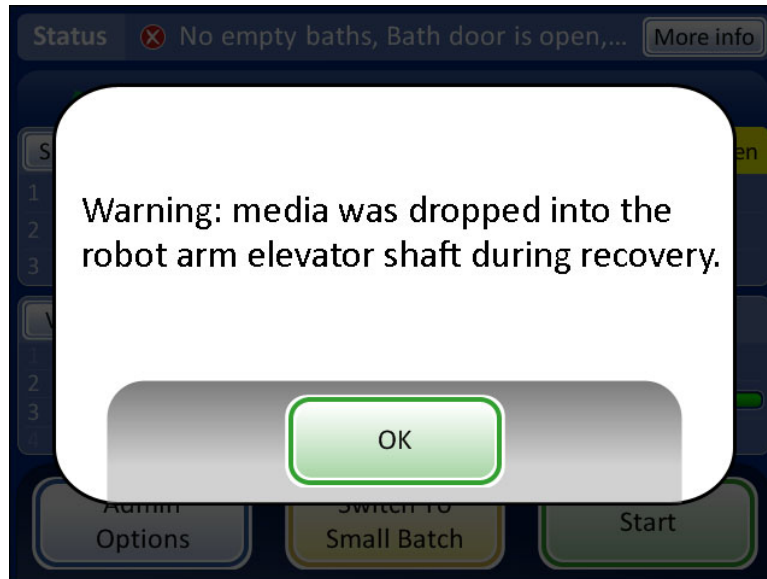

Figure 9-7 Media in the Elevator Shaft Message

If the robotic arm was holding a vial, filter or slide during error recovery, the item may have been released down into the elevator shaft. It can be retrieved from the waste tray at the bottom of the shaft.

Open the filter cabinet door. The bottom-most tray of filters may have to be removed. Reach into the waste tray located at the bottom left.

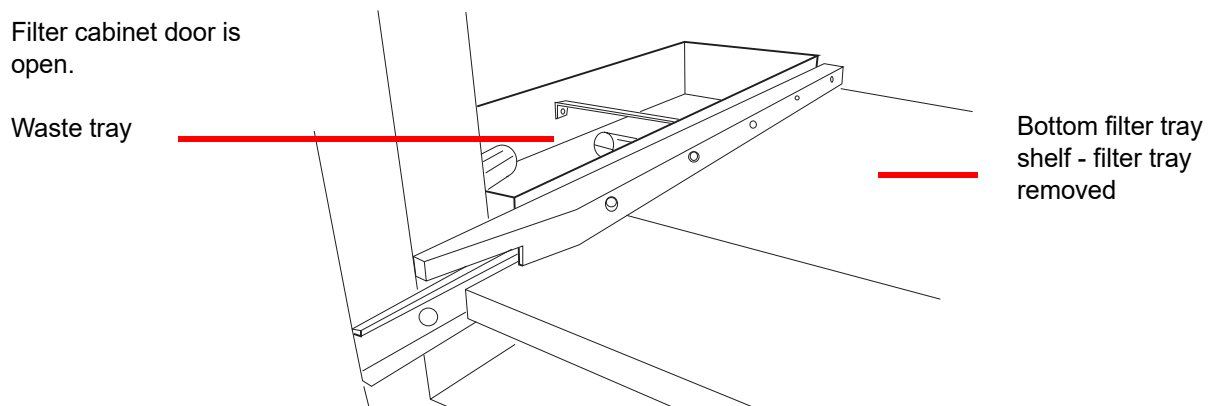

Figure 9-8 Robotic Arm Elevator Shaft Waste Tray

System Error Code

A system error has a two-part error code associated with it. The first four digits represent the error category and the following characters represent the status of the particular electromechanical device at the time the fault occurred. See Figure 9-9.

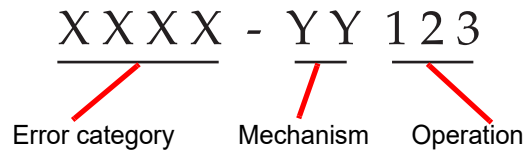

Figure 9-9 System Error Code

The error codes will be logged in the Error History report. The report displays the last 100 errors, but keeps up to 3 years' worth in the system database.

In most cases, the Clear Media dialog box will display. Check that the mechanisms are clear and begin a new batch.

If an error is persistent, contact Technical Support.

6000 series - Slide Handling Errors

6100 series - Database Errors

6200 series - Filter and Vial Handling Errors

6300 series - Pneumatic Errors

6400 series - Input Carousel Errors

(This includes main door lock/unlock errors)

6500 series - Output Carousel Errors

(This includes output door lock/unlock errors)

6600 series - AutoLoader Errors

6700 series - UPS Errors

6800 series - Machine/General Errors



TROUBLESHOOTING

This page intentionally left blank.

10. Staining and Cover slipping

10. Staining and Cover slipping

Chapter Ten

Staining and Coverslipping

SECTION A

GENERAL

Following is a description of *recommended guidelines* for fixation procedures, staining protocols, and coverslipping methods.

Note: There is wide variation among laboratories in fixation, staining, and coverslipping methods employed for cytologic specimens. The thin layer characteristics of ThinPrep® processor- prepared slides allow precise assessment of the effects of these differences in protocols and allows the laboratory personnel to optimize their methods by following the general guidelines provided in this section. These guidelines are recommendations and should not be considered absolute requirements.

SECTION B

FIXATION

The ThinPrep 5000 processor with AutoLoader deposits completed slides into a staining rack immersed in a fixative bath that contains 95% reagent alcohol or 95% ethyl alcohol. Use the following procedure to fix ThinPrep microscope slide preparations.

- **Gyn slides:** ThinPrep microscope slides should be fixed for at least 10 minutes prior to staining.
- **For Gyn slides intended for use with the ThinPrep® Imaging System:** ThinPrep microscope slides should be fixed for at least 10 minutes prior to staining. If the slides must be shipped to another site prior to staining, CellFyx™ Solution fixative must be applied.

Note: No other spray fixative has been validated for use with the ThinPrep Imaging System. Contact Hologic Customer Service for ordering. See the instructions for use that come with the fixative solution.

Note: If the slides are being prepared for use with the ThinPrep Imaging System, please refer to the Image Processor Operator's Manual first.

- **Non-Gyn slides:** ThinPrep microscope slides should be fixed for at least 10 minutes prior to staining or application of fixative spray.

10

STAINING AND COVERSLIPPING

Note: Some non-gyn slides will drop into a dry bath or PreservCyt Solution, depending on the type being run.

Change the fixative every 100 slides, or once per day, whichever comes first.

SECTION C

RECOMMENDED STAINING GUIDELINES

Staining times are different for ThinPrep-prepared slides in comparison to conventional preparations and should be adjusted accordingly.

- Use graded concentrations of alcohol (50% or 70%) to lower the potential for osmotic shock or possible cell shedding during staining.
- The use of mild bluing solutions and dilute acid baths will optimize nuclear staining and minimize possible cell shedding. Hologic recommends the use of a dilute Lithium Carbonate solution, or Ammonium Hydroxide solution as the bluing solution.
- Avoid the use of strong salt solutions, like *Scotts Tap Water Substitute*.
- Bath solution heights should completely cover the slides to reduce the chance of cell shedding during staining.
- For optimal results, slides should be agitated for at least 10 dips in each bath.

Below are the maximum concentrations to be used for the following solutions during the staining process:

Hydrochloric acid (HCl) 0.025%

Lithium Carbonate (bluing) baths 10mg per 1 liter¹

Acetic acid 0.1%

Ammonium Hydroxide 0.1%

For Gyn slides intended for use with the ThinPrep Imaging System, consult recommended staining protocols found in the ThinPrep Stain User's Manual.

1. Refer to Bales, CE. and Durfee, GR. *Cytologic Techniques* in Koss, L, ed. *Diagnostic Cytology and its Histopathologic Basis*. 3rd Edition. Philadelphia: JB Lippincott. Vol. II: pp 1187–1260 for details

Table 10.1: Hologic Staining Protocol

	Solution	Time*
1.	70% Reagent Alcohol	1 minute with agitation
2.	50% Reagent Alcohol	1 minute with agitation
3.	Distilled H ₂ O (dH ₂ O)	1 minute with agitation
4.	Richard-Allan Hematoxylin I	30 seconds with agitation
5.	Distilled H ₂ O (dH ₂ O)	15 seconds with agitation
6.	Distilled H ₂ O (dH ₂ O)	15 seconds with agitation
7.	Clarifier (0.025% glacial acetic acid)	30 seconds with agitation
8.	Distilled H ₂ O (dH ₂ O))	30 seconds with agitation
9.	Bluing Reagent (10mg LiCarb/1L)	30 seconds with agitation
10.	50% Reagent Alcohol	30 seconds with agitation
11.	95% Reagent Alcohol	30 seconds with agitation
12.	Richard-Allan Cytology Stain	1 minute with agitation
13.	95% Reagent Alcohol	30 seconds with agitation
14.	95% Reagent Alcohol	30 seconds with agitation
15.	100% Reagent Alcohol	30 seconds with agitation
16.	100% Reagent Alcohol	30 seconds with agitation
17.	100% Reagent Alcohol	30 seconds with agitation
18.	Xylene	1 minute with agitation
19.	Xylene	1 minute with agitation
20.	Xylene	3 minutes with agitation
21.	Mount per your laboratory's protocol	

*Time may vary with laboratory preference.

10

STAINING AND COVERSIPPING

SECTION D

COVERSLIPPING

Each laboratory should evaluate their choice of coverslip and mounting media to ensure compatibility with ThinPrep slides.

Hologic also recommends that 24 mm x 40 mm or 24 mm x 50 mm glass coverslips be used. Plastic coverslip material used with automated coverslipping instrumentation is also acceptable.

If you are staining and coverslipping for ThinPrep Imaging System slides, please see the Image Processor Operator's Manual first.

Chapter Eleven

ThinPrep Pap Test Training Program

SECTION A

OBJECTIVE

The ThinPrep Pap Test Training Program was developed by Hologic to assist laboratories in the conversion process from the conventional Pap smear to the ThinPrep Pap test. Hologic offers information, support and training for the conversion process, including communicating the change to the clinician, cytopreparatory training, ThinPrep Pap test morphology training and guidelines to assist with training the entire cytology staff in the laboratory.

SECTION B

DESIGN

Morphology Training is designed to communicate the differences between the conventional Pap smear and the ThinPrep Pap test. The participants use a series of slide modules to familiarize themselves with a spectrum of normal and abnormal cytological entities on ThinPrep Pap test samples.

This program is based on a cumulative learning process. Interpreting the morphologic criteria of ThinPrep Pap test samples requires review and application of cytology skills and knowledge. A systematic approach allows for frequent assessment of an individual's understanding of the ThinPrep characteristics. The training program incorporates both pre- and post- tests in order to assess learning progress.

The training begins with the ThinPrep morphology lecture, which is designed to familiarize the participants with the microscopic presentation of cervical samples prepared using the ThinPrep System. The format summarizes the morphologic features common to specific diagnostic entities described in *The Bethesda System for Reporting Cervical/Vaginal Cytologic Diagnoses*¹.

Following the introductory lecture, a module of known ThinPrep Pap test cases are reviewed by all participants. This module presents a wide variety of diseases and disease states and provides the participant a base reference for the full range of the diagnostic categories to be encountered. Review of "look-alike" cases is also included. Through the use of the ThinPrep Gyn Morphology Atlas, which highlights common diagnostic entities and their differential diagnoses, participants will begin to recognize key look-alike entities on ThinPrep slides and the criteria that can be used in their proper classification.



THINPREP PAP TEST TRAINING PROGRAM

A series of modules of unknown ThinPrep Pap test cases is used to assess the ThinPrep screening and interpretive skills of each participant. Participants are required to screen and diagnose each set of cases and record their results on the provided answer sheet. Once complete, the cases and correct responses are reviewed individually by each participant.

A final set of unknown ThinPrep Pap test slides is provided. This final set of slides is modeled after current CLIA guidelines and will be scored by Hologic-designated personnel. Successful completion of these slides is necessary to receive a certificate of completion.

CLIA Proficiency Test Program standards are used as guidelines in establishing pass/fail scoring criteria. Individuals receiving a 90% or better on the Final Assessment are qualified to screen/interpret ThinPrep Pap test cases and to begin training additional cytotechnologists and pathologists in their laboratory under the supervision of the laboratory Technical Supervisor, if needed. Participants of the training program receiving less than 90% on the Final Assessment would require remedial training in their individual laboratories. This training involves the screening/diagnosing of an additional ThinPrep Pap test slide module provided by Hologic and requires a score of 90% or better to complete Hologic's ThinPrep Pap Test Training Program.

Cytology Staff Training

Hologic supports cytology staff training by providing information and resources, such as slides, answer sheets, and online educational material, for use by the lab in training additional staff. The laboratory Technical Supervisor is ultimately responsible for ensuring adequate training for individuals prior to screening and interpreting ThinPrep Pap test cases.

SECTION C

BIBLIOGRAPHY

1. Nayar R, Wilbur DC. (eds). *The Bethesda System for Reporting Cervical Cytology: Definitions, Criteria, and Explanatory Notes*. 3rd ed Cham, Switzerland Springer:2015.

Service Information

Service Information

Chapter Twelve

Service Information

Corporate Address

Hologic, Inc.
250 Campus Drive
Marlborough, MA 01752 USA

Business Hours

Hologic's business hours are 8:30 a.m. to 5:30 p.m. EST Monday through Friday, excluding holidays.

Customer Service

Product orders, which include standing orders, are placed through Customer Service by phone during business hours at 1-800-442-9892 Option 5 or 508-263-2900.

Orders can also be faxed to the attention of Customer Service at 508-229-2795.

Warranty

A copy of Hologic's limited warranty and other terms and conditions of sale may be obtained by contacting Customer Service at the numbers listed above.

Technical Support

For questions about ThinPrep[®] 5000 processor with AutoLoader issues and related application issues, representatives from Technical Support are available by phone 7:00 a.m. to 7:00 p.m. EST Monday through Friday at 1-800-442-9892 Option 6 or 508- 263-2900.

Service contracts can also be ordered through Technical Support.

Protocol for Returned Goods

For returns on warranty-covered ThinPrep 5000 processor with AutoLoader accessory and consumable items, contact Technical Support.

Service contracts can also be ordered through Technical Support.



SERVICE INFORMATION

This page intentionally left blank.

Ordering Information

Ordering Information

Chapter Thirteen

Ordering Information

Mailing Address

Hologic, Inc.
250 Campus Drive
Marlborough, MA 01752 USA

Remittance Address

Hologic, Inc.
PO Box 3009
Boston, MA 02241-3009 USA

Business Hours

Hologic's business hours are 8:30 a.m. to 5:30 p.m. EST Monday through Friday, excluding holidays.

Customer Service

Product orders, which include standing orders, are placed through Customer Service by phone during business hours at 1-800-442-9892 Option 5 or 508-263-2900.

Orders can also be faxed to the attention of Customer Service at 508-229-2795.

Warranty

A copy of Hologic's limited warranty and other terms and conditions of sale may be obtained by contacting Customer Service at the numbers listed above.

Protocol for Returned Goods

For returns on warranty-covered ThinPrep® 5000 processor with AutoLoader accessory and consumable items, contact Technical Support.



Table 13.1: Supply Items for the ThinPrep 5000 Processor

Item	Description	Order Number
Absorbent pad, filter plug	Package of 4 absorbent pads	71920-001
Absorbent pad, evaporation cover	Package of 4 absorbent pads	71921-001
Pad, robotic arm waste bin	Pad to line the robotic arm waste bin	ASY-03901
Fixative bath	Bath container plus cover, package of 1	71917-001
Staining rack	Staining racks, case of 10	51873-001
Waste bottle assembly	Waste bottle plus cap	70028-001
Input carousel	Package of 1 input carousel	ASY-11050
Dust cover	1 dust cover for input carousels	71918-001
ThinPrep 5000 with AutoLoader Operator's Manual	1 replacement manual	MAN-06025-001
Vortexor	1 vortexor	*
15A/250V 3AB SLO-BLO fuse	Replacement fuses for the processor	53247-015
6.3A/250V 5x20mm fuses	Replacement fuses for the AutoLoader	50077-021
Filter, carbon	0.3 micron carbon filter for the fume extraction system	MME-00900
Filter, HEPA	0.3 micron HEPA filter for the fume extraction system, package of 5	MME-00901
Sample vial trays	Trays for holding sample vials, package of 4	70264-001
Liner bags for filter waste bin	Poly plastic bags, 14" x14" x26", 1 carton of 500 bags	50816-001

** Order number depends upon specific power requirements for each country. Contact Hologic Customer Service.*

Table 13.2: Supplies for the ThinPrep Pap Test (Gynecologic) Application

Item	Description	Order Number
ThinPrep Pap Test Kit	Materials for 500 ThinPrep Pap Tests Contains: 500 Vials of PreservCyt Solution for use with the ThinPrep Pap Test 500 ThinPrep Pap Test Filters (Clear) 500 ThinPrep Microscope Slides 500 Collection Devices Configured with: 500 Broom-like Collection Devices 500 Cytobrush/Spatula Collection Devices	 70096-001 70096-003
ThinPrep Pap Test Kit (for use with the ThinPrep Imaging System)	Materials for 500 ThinPrep Pap Tests Contains: 500 Vials of PreservCyt Solution for use with the ThinPrep Pap Test 500 ThinPrep Pap Test Filters (Clear) 500 ThinPrep Imaging System Microscope Slides 500 Collection Devices Configured with: 500 Broom-like Collection Devices 500 Cytobrush/Spatula Collection Devices	 70662-001 70662-003

Table 13.2: Supplies for the ThinPrep Pap Test (Gynecologic) Application

Item	Description	Order Number
ThinPrep Pap Test Physician Office Kit	Contains: 500 Vials of PreservCyt Solution for GYN Configured with: 500 Broom-like Collection Devices 500 Cytobrush/Spatula Collection Devices	70136-001 70136-002
ThinPrep Pap Test Laboratory Kit	Contains: 500 ThinPrep Pap Test Filters (Clear) 500 ThinPrep Microscope Slides	70137-001
ThinPrep Pap Test Laboratory Kit (for use with the ThinPrep Imaging System)	Contains: 500 ThinPrep Pap Test Filters (Clear) 500 ThinPrep Imaging System Microscope Slides	70664-001
Broom-Like Collection Devices Kit	Contains: 500 Broom-like Collection Devices (20 bags of 25 devices)	70101-001
Cytobrush/Plastic Spatula Kit	Contains: 500 Cytobrush/Spatula Collection Devices (20 bags of 25 device pairs)	70124-001

Table 13.3: Supplies and Solutions for Non-Gynecologic Applications

Item	Description	Order Number
PreservCyt Solution	20 mL in a 2-oz. vial 50 vials/box	0234005
	946 mL in a 32-oz. bottle 4 bottles/box	0234004
Cytolyt Solution	946 mL in a 32-oz. bottle 4 bottles/box	0236004
	30 mL in a 50-mL centrifuge tube 80 tubes/box	0236080
	30 mL in a 120-mL cup 50 cups/box	0236050
Dispenser Pump	1 Pump for Cytolyt quart (32 oz.) bottle Dispenses approximately 30 mL.	50705-001
Non-Gyn Filters (Blue)	Box of 100	70205-001
ThinPrep UroCyte® System Kit	100 ThinPrep UroCyte filters (Yellow) 100 UroCyte microscope slides 2 PreservCyt vial 50-packs 4 bottles of Cytolyt Solution (946 mL in a 32-oz. bottle)	71003-001
ThinPrep UroCyte Filters (Yellow)	100 filters per tray	70472-001
ThinPrep UroCyte Microscope Slides	100 slides per box	70471-001
ThinPrep UroCyte PreservCyt Cups	50 cups per case	70991-001
ThinPrep UroCyte Urine Collection Kit	12 kits per case	70474-001
Arc-less slides (for IHC stains)	Box, 1/2 gross	70126-002



ORDERING INFORMATION

This page intentionally left blank.



Index

A

- absorbent pad
 - evaporation cover 8.16, 13.2
 - filter plug 8.16, 13.2
- Administrative Options 6.22
- alert tones 6.29
- aliquot removal 7.35
- ancillary testing 7.35

B

- barcode label format
 - slide 7.22
 - vial 7.3
- batch complete 6.18, 7.18, 7.33
- batch processing errors 9.12
- bath details 6.10
- baths pane on main screen 6.10
- bloody specimens (non-gyn) 5.23

C

- carbon filter 13.2
- carousel
 - ordering 13.2
 - report 6.74
 - sensors 8.5
- change fixative reagent 8.2
- clean screen button 6.35
- clean system 8.3
- clean system button 6.63
- clean touch screen 8.14
- clear media 9.19



INDEX

- clearances 1.11
- COBAS AMPLICOR™ CT/NG Test 7.35
- Collection
 - Broom-like device 4.3
 - broom-like device 13.4
 - Endocervical brush/Spatula device 4.4, 13.4
- collection media 5.4
- Configure barcodes 6.42
 - accession ID 6.45
 - configure slide ID 6.50
 - laser-etched slides 6.50
 - replace 6.52
 - segment 6.51
 - test settings, vial ID 6.48
- Configure slide ID 6.50
- Configure vial ID 6.44
- coverslipping 10.4
- Customer Service 12.1, 13.1
- CytoLyt Solution 3.4, 13.5
 - composition 3.4
 - handling/disposal 3.5
 - packaging 3.4
 - stability 3.4
 - storage requirements 3.4
- CytoLyt Solution wash 5.12

D

- date 6.25
- design slide labels 6.36
- dimensions 1.11
- Disposal
 - consumables 1.19
 - instrument 1.20
- DiThioThreitol (DTT) procedure 5.16
- drip trays 8.20
- dust cover, ordering 13.2



E

empty liquid waste tank 6.35, 7.22, 8.9, 9.15
Environmental 1.12

F

fixation 10.1
fixative bath status 6.12
fixative bath, ordering 13.2
fluid specimens
 collection 5.3
 preparation 5.17
FNA specimens
 collection 5.3
 preparation 5.14
fuse
 ordering 13.2
 replacing 8.20
 specifications 1.12

G

gather diagnostics 6.77
glacial acetic acid 4.6, 5.23
gynecologic sample preparation 4.1

H

hazards 1.14
HEPA filter 13.2

I

install printer 6.33
installation 2.1



INDEX

instrument name 6.27
Intended use (ThinPrep 5000 Processor) 1.2
interrupt a batch 6.19

L

lab name 6.26
language selection 6.31
leak test 8.12
Load
 baths 6.13
 carousel 7.14
 filters, slides, vials 7.25
 slide cassette with slides 7.7
lubricant 4.2, 4.5

M

main screen
 during processing 6.16
 processor idle 6.3
maintenance schedule 8.23
material safety data sheet
 CytoLyt Solution 3.5
 PreservCyt Solution 3.3
move bath to door 6.12
muroid specimens
 collection 5.3
 preparation 5.15
Multiple Slide per Vial processing mode 7.29

N

non-gyn filters 7.2, 13.5
non-gyn sample prep troubleshooting 5.22
non-gyn sample preparation 5.1



O

OCR label format 7.23
operator's manual, ordering 13.2

P

pad, robotic arm waste bin 13.2
pause a batch 6.19, 7.32
power 1.12
power off 2.7
power on 2.5
power on self test 1.14
power switch 2.5
PreservCyt Solution 3.1, 13.5
 antimicrobial properties 3.3
 composition 3.1
 packaging 3.1
 stability 3.2
 storage requirements 3.1
process sequences 6.9
processing complete 6.18

R

release filter 9.20
release slide 9.21
release vial 9.21
remove baths 6.13
replace characters 6.52
reprocessing protocol, gyn 4.6
restart the system 9.23
restricted mode 9.18



S

- safety data sheet
 - CytoLyt Solution 3.5
 - PreservCyt Solution 3.3
- sample is dilute 9.2
- sample processing errors 9.1
- sample too dense 9.2
- save a report to USB key 6.71
- segment of ID 6.51
- shutdown
 - extended 2.8
 - normal 2.7
- silence alarm 6.30
- slide details 6.7
- Slide ID
 - duplicate 9.9
 - invalid 9.5
 - read error 9.3
- Slide ID format
 - 1-D barcode 6.37
 - 2-D barcode 6.38
 - configure barcodes 6.42
 - OCR Imager 6.37
 - OCR Non-Imager 6.39
 - restrictions 6.39
- slide label format for Imaging 7.24
- Slide labels
 - text 6.40
- slide types 6.7
- slides pane on main screen 6.6
- sound volume 6.28
- specimen collection, gyn 4.3
- staining 10.2
- staining rack 7.13
 - ordering 13.2
- start a batch 7.15
- status bar 6.3



- status indicators 6.5, 7.21
- switch modes 6.21
- symbols used on the instrument 1.15
- system errors 9.18
 - codes 9.23
- system settings 6.24

T

- Technical Support 12.1
- ThinPrep Pap Test 1.2
- ThinPrep Pap Test filters 7.2, 13.3
- ThinPrep Pap Test kit 13.3
- time 6.25
- touch screen cleaning 8.14
- tray processing, stop on empty or search all 6.33
- troubleshooting 9.1

U

- Uncap vial 9.2
- unload
 - carousel 7.20
 - fixative bath 7.20
- UPS 2.1
- urine specimens
 - collection 5.4
 - preparation 5.17
- UroCyte collection kit 5.20
- UroCyte filters 7.2, 13.5
- UroCyte specimens 5.19
- usage details 6.73
- USB ports 2.5



INDEX

V

- vial and slide ID pre-match 6.31
- vial details 6.9
- Vial ID
 - invalid 9.4
 - read error 9.3
- vial labels 7.3
- vials pane on main screen 6.8
- voltage 1.12

W

- Warnings, Cautions, Notes 1.14
- waste bottle
 - connection 8.13
 - emptying 8.9
 - ordering 13.2
- weight 1.11, 2.2

AutoLoader Mode - Idle

- Administrative Options:
- System Settings
 - Reports and Logs
 - Clean Screen
 - Empty Liquid Waste
 - Design Labels
 - Configure Barcodes
 - Clean System
 - Change Air Filter
 - Shutdown the instrument

AutoLoader Mode - Processing

- Vial Tray 1 (Gyn) completed processing
- Vial Tray 2 (Non-Gyn) is processing
- Vial Tray 3 (UroCyte) needs operator action
- Vial Tray 4 (Imager) ready for processing

Status Indicators Used on the Interface



- Full slide cassette or filter tray
- Partial slide cassette or filter tray
- Empty slide cassette or filter tray



- Sample type being processed (Non-Gyn example)
- Number of Non-Gyn slide cassettes available
- Number of Non-Gyn filter trays available
- Number of Non-Gyn fixative baths available



Ready for processing



Completed



The batch has been paused



Not ready or error. Read the message in the status bar.



Vial tray cannot be processed - missing or low inventory



User action prompt

Refer to the ThinPrep 5000 Autoloader Operator's Manual for complete operating instructions.

AutoLoader Mode

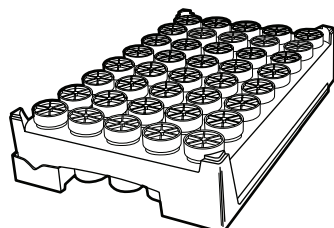

1 Tray = 1 Batch Report

Small Batch Mode

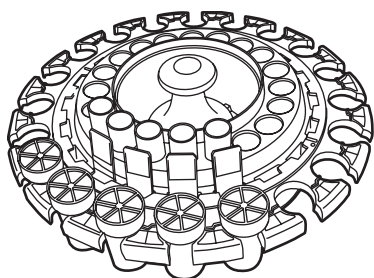

1 Carousel = 1 Batch Report

Batch Reports

Refresh

Select a batch report to view details

Sample Type	Date	Time ▼
Gyn	Tue 9/11/2018	12:00 AM
Non-Gyn	Mon 9/10/2018	5:00 AM
UroCyte	Sun 9/9/2018	9:00 PM
Gyn	Sat 9/8/2018	12:00 AM
Gyn	Fri 9/7/2018	3:00 PM

Done
Save All To USB
Find Vial By ID

Important Operational Notes

Fixative Baths

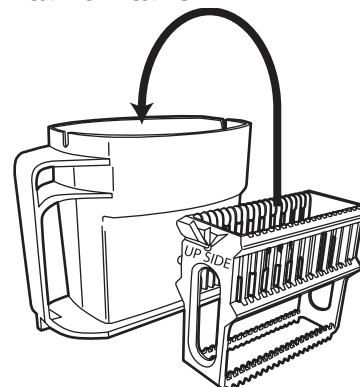

Fixative baths - orient the staining rack so that the embossed words "UP SIDE" face the bath handle. Press the staining rack all the way down until it can be felt to snap into place. The rack must be fully seated.

Filter trays

When loading filter trays, confirm the filters are membrane-side down in the tray (open end oriented up). Manually flip them over, if necessary. Take care not to touch the membrane or inner surface of the filter.

Push filter trays fully into the bay to engage the tray-present sensor. If loading a partially used filter tray, load it with the empty positions at the leading edge. After the system locates the first filter present, it assumes the remainder of the tray is full.

Designate Sequence Type

When loading vial trays, filter trays or slide cassettes, the operator must designate the sample type for each item. The system does not recognize the type of vial, filter or slide on its own.

Select vial tray 1 sequence

Gyn

Imager

Non-Gyn

UroCyte

Select filter tray 1 type

Gyn / Imager

Non-Gyn

UroCyte

Select slide cassette 1 type

Gyn

Imager

Non-Gyn

UroCyte

Hologic® ThinPrep® 50000 Processor Operator's Manual With AutoLoader



Hologic, Inc.
250 Campus Drive
Marlborough, MA 01752 USA
1-800-442-9892
+1-508-263-2900
www.hologic.com

MAN-06025-001 Rev. 002