

LOCALIZER™

Tag Applicator Tag Applicator S

Instructions for Use

R_x ONLY

DESCRIPTION

RFID Localization System

The Tag Applicator, LOCALIZER™ Reader, and LOCALIZER Surgical Probe are components of the RFID Localization System. The Tag is intended to be placed in breast tissue, within 6 cm of the breast surface, using the Tag Applicator. The Tags, when used in conjunction with the LOCALIZER Reader and LOCALIZER Surgical Probe, can be used as a guide for the surgeon to follow in the excision of tissue.

RFID Localization System (RFLS) components are listed below:

System Component		Part Number
LOCALIZER Reader	RFID Reader	HB100
LOCALIZER Surgical Probe	Attachment probe for use with LOCALIZER RFID reader	HB110
Tag Applicator	Needle applicator with preloaded RFID Tag: <ul style="list-style-type: none"> • 5 cm length • 7 cm length • 10 cm length 	<ul style="list-style-type: none"> • HB200-05 • HB300-05 • HB200-07 • HB300-07 • HB200-10 • HB300-10

The LOCALIZER Instrument Drape (HB120) is provided separately for use with the LOCALIZER Reader in a sterile environment.

Tag Applicator with preloaded Tag

The Tag Applicator is a sterile, single use device composed of a:

- 12 Gauge Applicator needle
- One Tag

The Tag Applicator consists of a plastic molded handle and a beveled 12 GA introducer needle with locking plunger. Needles are provided in approximately 5, 7, or 10 cm lengths and include 1 cm depth reference marks (*Figure 1*). The Tag is preloaded inside the needle and is deployed into the tissue site under ultrasound or x-ray guidance.

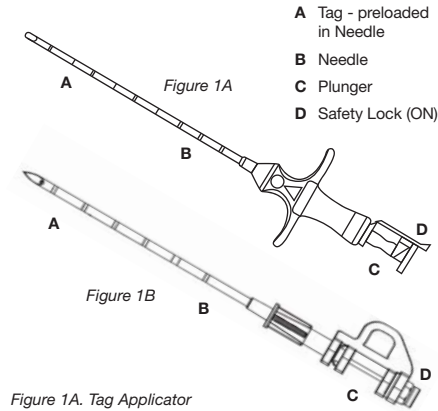

Figure 1A. Tag Applicator
Figure 1B. Tag Applicator S

The Tag is approximately 10.6 mm long and 2 mm in diameter and includes a polypropylene cap designed to prevent migration in tissue (*Figure 2*). The Tag is designed to provide a detectable signal when the LOCALIZER Reader moves over it allowing the LOCALIZER Reader to provide a corresponding audible tone and distance readout that identifies the implanted Tag's location. The Tag is visible via ultrasound, x-ray, and MRI. The Tag must be placed at a tissue depth of ≤ 6 cm from the skin surface to be detectable by the LOCALIZER Reader.

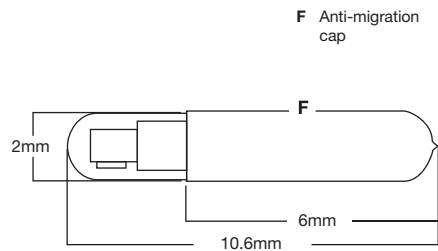

Figure 2. Tag (A)

INDICATIONS FOR USE

The Tag of the RFLS is intended for percutaneous placement in the breast to mark (>30 days) a lesion intended for surgical removal. Using image guidance (such as ultrasound or radiography) or aided by non-imaging guidance (RFLS), the RFID Tag is located and surgically removed with the target tissue. The RFLS is intended only for the non-imaging detection and localization of the Tag that has been implanted in a lesion intended for surgical removal.

CONTRAINDICATIONS

The RFID Localization System is not intended for use under conditions where breast lesion localization is contraindicated.

The RFID Localization System is not intended for use in the heart, eyes, brain or spinal cord.

The Tag should not be placed in a tissue site with clinical evidence of infection.

The Tag should not be placed in muscle tissue.

WARNINGS

The Tags are designed only for use with the LOCALIZER Reader and Surgical Probe.

The Tag Applicator is intended for sterile use. Do NOT use this product on a non-sterile surface prior to use internally.

Caution should be exercised with using the device on patients with prostheses so as to not puncture the prosthesis during placement.

If any resistance is felt during advancement of the needle, carefully correct the orientation of the needle but never apply strong forces in order to overcome the obstacle.

Exercise caution when placing the Tag near the chest wall. Insert the Needle applicator parallel to the chest wall so as to not puncture the chest wall during placement.

Exercise caution during surgical excision of the lesion to avoid cutting or damaging the Tag. When using electrosurgical tools, avoid direct contact with the Tag as thermal damage can result. If the Tag is inadvertently damaged, ensure all parts of the Tag are retrieved from the surrounding tissue.

The Tag and Applicator needle have been designed for SINGLE USE only. Reusing this medical device bears the risk of cross-patient contamination. The residue of biologic material can promote the contamination of the device with pyrogens or microorganisms which may lead to infectious complications.

DO NOT RESTERILIZE. After sterilization, the sterility of the product is not guaranteed because of an indeterminable degree of potential pyrogenic or microbial contamination which may lead to infectious complications. Cleaning, reprocessing and/or re-sterilization of the present medical device increases the probability that the device will malfunction due to potential adverse effects on components that are influenced by thermal and/or mechanical changes.

Do NOT use if the package is open or damaged.

Use the Tag Applicator prior to the expiration date shown on the product label.

To avoid confusion between signals produced by both Tags, it is recommended that no more than one Tag is implanted in the same operative breast.

PRECAUTIONS

This product should only be used by a physician who is completely familiar with the indications, contraindications, limitations, typical findings and possible side effects of tissue Tag placement.

Do NOT use the Tag Applicator if needle is bent and/or tip is damaged.

Handle the Tag Applicator in a manner that will prevent accidental contamination.

Do NOT remove Safety Lock from applicator until needle has been advanced to desired location for Tag deployment.

Do NOT implant Tag greater than 6 cm deep from the breast surface to accommodate the LOCALIZER Reader detection range.

Ensure the Tag is completely deployed in the breast tissue by depressing the plunger until it contacts the Applicator barrel.

After use, the Tag Applicator and Tag are biohazards. Dispose in accordance with your facility's biohazardous waste procedures.

ADVERSE REACTIONS

None known.











HOW SUPPLIED

The Tag Applicator is provided sterile and is intended for single patient use only. The Tag Applicator is not made with natural rubber latex. The Tag is non-pyrogenic.

STORAGE

Store at ambient temperature 15° to 30°C (59° to 86°F)

SYMBOLS

Symbol	Description
	Use by Date
YYYY-MM-DD	Expiration date is represented by the following: YYYY represents the year MM represents the month DD represents the day
	Caution
	Follow instructions for use
	Do NOT use if package is damaged
	Do NOT resterilize
	Single use only
R_x ONLY	U.S. Federal law restricts this device to sale by or on the order of a physician
	Sterilized using Ethylene Oxide
	Manufacturer
	Catalog Number
	Batch Code

MRI SAFETY INFORMATION



MR Conditional

Non-clinical testing demonstrated that the Tag is MR Conditional. A patient with this device can be scanned safely in an MR system under the following conditions:

Static magnetic field of 1.5 T and 3 T.

Maximum spatial field gradient of 4,000 G/cm (40 T/m).

Maximum MR system reported, whole body averaged specific absorption rate (SAR) of 2 W/kg in the Normal Operating Mode.

Under the scan conditions defined, the Tag is expected to produce a maximum temperature rise of 2°C.

In non-clinical testing, the image artifact caused by the Tag extends approximately 25 mm from this implant when imaged using a gradient echo pulse sequence and a 3 T MR system.

Manufactured for:
Health Beacons, Inc.
383 Lowell Rd.
Concord, MA 01742
Phone: (978) 254-6500

ML-0012 Rev 03

DIRECTIONS FOR USE

NOTE: These instructions are NOT meant to define or suggest any medical or surgical technique. The individual physician is responsible for the proper procedure and techniques to be used with this product.

Set-up

1 Inspect the packaging to ensure that package integrity has not been compromised. The product is sterile unless the seal is broken and expiration date has not been exceeded.

2 Before removing from the sterile packaging, use the Localizer Reader (*Figure 3*) to verify that the Tag ID is within the Tag Applicator and functioning:

Press the power button to turn the Localizer Reader on.

Use the up and down arrows on the brightness control to adjust the screen to the desired intensity.

Check the battery charge indicator to ensure there is adequate charge.

Use the up and down arrows on the volume control to adjust the audio tone to the desired volume.

Scan the Localizer Reader Loop Probe (G) over the end of the Applicator needle where the Tag is housed.

WARNING: The Localizer Reader is a non-sterile device. Do NOT touch the Tag Applicator directly with the Localizer Reader.

3 Note the unique identification number of the Tag displayed on the screen of the Localizer reader.

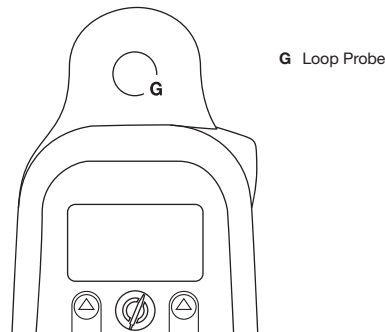
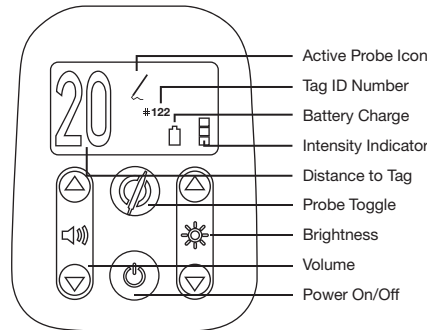

Figure 3. Localizer Reader (control details top)

4 Using standard aseptic technique, remove the Tag Applicator (*Figure 1*) from the package. Remove the Protector Cap which covers the needle tip. Inspect the tip for signs of damage. Do NOT use the device if there are signs of damage.

Delivery

1 Identify the target breast lesion using preferred imaging techniques (ultrasound or x-ray). Locate the desired placement location. The placement location should be no deeper than 6 cm from the breast surface to allow for Localizer Reader detection.

2 Determine the skin entry site and prepare the sterile site for Tag implantation.

3 Percutaneously, advance the Applicator needle (B) into the breast tissue directing the needle tip to the target site. The markers on the needle can be used as a reference for needle depth.

4 Confirm needle placement with appropriate imaging technique. If necessary, reposition the needle and reconfirm placement.

5 Remove the Safety Lock (D) from the Applicator.

6 Verify the Tag position using the preferred imaging technique.

7 While maintaining the position of the Applicator stable, deploy the Tag by advancing the plunger (C) until it contacts the Applicator barrel.

8 Remove the Tag Applicator and confirm final tag position with preferred imaging technique. A two view mammogram is recommended.

9 Confirm the Tag position and functionality using the Localizer Reader. Refer to the Localizer Reader instructions for additional device operation.

10 Note the Tag position and ID for subsequent excision.

Removal

NOTE: Refer to the Localizer Reader instructions for equipment details and proper operation.

1 Determine the proximity of the Tag by using the Localizer Reader, and/or by using imaging guidance (such as ultrasound or radiography).

WARNING: Exercise caution during surgical excision of the lesion to avoid damaging the Tag.

2 Perform excision of the intended tissue using the Localizer Reader or imaging (ultrasound or radiography) for guidance.

3 Confirm the Tag is present in the excised specimen using the Localizer Reader or imaging (ultrasound or radiography).