

SELENIA®  
Dimensions®  
**3Dimensions™**



**Quality Control Manual**  
MAN-03706 Revision 010

**HOLOGIC®**



# **Selenia<sup>®</sup> Dimensions<sup>®</sup>**

# **3Dimensions<sup>™</sup>**

Digital Mammography System

Digital Tomosynthesis System

## **Quality Control Manual**

DM, BT, and CEDM Modalities

For Software Versions 1.8, 1.9, 1.10, 1.11, 2.0, 2.1, or 2.2

Part Number MAN-03706

Revision 010

August 2020

**HOLOGIC<sup>®</sup>**

## **Technical Support**

USA: +1.877.371.4372

Europe: +32 2 711 4690

Asia: +852 37487700

Australia: +1 800 264 073

All Other: +1 781 999 7750

Email: [BreastHealth.Support@hologic.com](mailto:BreastHealth.Support@hologic.com)

© 2015-2020 Hologic, Inc. Printed in the USA. This manual was originally written in English.

Hologic, 3Dimensions, Dimensions, Selenia, FAST Paddle, C-View, HTC, SecurView, SmartCurve, and associated logos are trademarks and/or registered trademarks of Hologic, Inc., and/or its subsidiaries in the United States and/or other countries. All other trademarks, registered trademarks, and product names are the property of their respective owners.

This product may be protected by one or more U.S. or foreign patents as identified at [www.Hologic.com/patent-information](http://www.Hologic.com/patent-information).

# Table of Contents

<b>1: Prologue</b>	<b>1</b>
1.1 Introduction.....	1
1.2 Intended Use of the System Quality Control Manual.....	2
1.3 How to Use the Quality Control Manual .....	3
1.4 Prerequisites .....	4
1.5 Change Summary .....	4
1.6 Terms and Definitions.....	7
1.7 Descriptions of Warnings, Cautions, and Notes .....	10
<b>2: Introduction</b>	<b>11</b>
2.1 Personnel Training.....	11
2.2 Responsibilities .....	12
2.3 Alternative Quality Control Standard .....	14
2.4 Quality Control Activities for the Medical Physicist .....	19
2.5 Quality Control Activities for the Radiologic Technologist.....	21
<b>3: Quality Control Activities for the Medical Physicist</b>	<b>23</b>
3.1 Mammographic Unit Assembly Evaluation .....	25
3.2 Collimation Assessment.....	26
3.3 Artifact Evaluation.....	37
3.4 kVp Accuracy and Reproducibility .....	44
3.5 Beam Quality Assessment—Half-Value Layer Measurement.....	46
3.6 Evaluation of System Resolution.....	49
3.7 Automatic Exposure Control (AEC) Function Performance.....	52
3.8 Breast Entrance Exposure, AEC Reproducibility, and AGD .....	57
3.9 Radiation Output Rate .....	63
3.10 Phantom Image Quality Evaluation.....	66
3.11 Signal-To-Noise and Contrast-To-Noise Measurements.....	69
3.12 Diagnostic Review Workstation Quality Control.....	76
3.13 Detector Ghosting (Troubleshooting Use Only).....	79
<b>4: Quality Control Activities for the Radiologic Technologist</b>	<b>83</b>
4.1 DICOM Printer Quality Control .....	85
4.2 Detector Flat Field Calibration.....	89
4.3 Geometry Calibration (Tomosynthesis Option) .....	92
4.4 Artifact Evaluation.....	94
4.5 Phantom Image .....	100
4.6 Signal-To-Noise and Contrast-To-Noise Measurements.....	103
4.7 Compression Thickness Indicator .....	110
4.8 Diagnostic Review Workstation Quality Control.....	112
4.9 Viewboxes and Viewing Conditions.....	115
4.10 Visual Checklist.....	116

# Quality Control Manual for Selenia Dimensions and 3Dimensions Systems

## Table of Contents

---

4.11 Repeat/Reject Analysis .....	117
4.12 Compression .....	119
<b>Appendix A Quality Control Forms for the Medical Physicist</b> .....	<b>121</b>
<b>Appendix B Quality Control Forms for the Radiologic Technologist</b> .....	<b>171</b>
<b>Appendix C Dose Conversion Tables for the Medical Physicist</b> .....	<b>205</b>
<b>Appendix D CNR Correction Tables</b> .....	<b>211</b>
D.1 CNR Correction - Conventional (Contact) .....	212
D.2 CNR Correction - Conventional (Magnification) .....	214
D.3 CNR Correction - Stereotactic Biopsy Option .....	216
D.4 CNR Correction - CE2D Option .....	216
D.5 CNR Correction - Tomosynthesis Option (15 Projections, STANDARD Mode) .....	217
D.6 CNR Correction - Tomosynthesis Option (15 Projections, ENHANCED Mode) .....	219
D.7 CNR Correction - Tomosynthesis Option (30 Projections, STANDARD Mode) .....	220
D.8 CNR Correction - Tomosynthesis Option (30 Projections, ENHANCED Mode) .....	221
D.9 CNR Correction - Contrast Enhanced Biopsy Option .....	222
D.10 Notes .....	223
<b>Appendix E Technique Tables</b> .....	<b>225</b>
<b>Appendix F Scoring a Phantom</b> .....	<b>229</b>

# Chapter 1 Prologue

## 1.1 Introduction

This quality control manual provides the necessary information for a facility that uses this mammography system to maintain an effective Quality Assurance and Quality Control (QA/QC) program, meet the requirements of the MQSA Final Regulations, and meet the requirements provided by the manufacturer of the Selenia Dimensions system.

This QC manual applies to the following systems:

- digital mammography (DM) system
- breast tomosynthesis (BT) system
- mobile versions of the above systems



**Note**

The digital mammography QC tests need to be performed even on a system that is intended exclusively for breast tomosynthesis plus C-View™ software imaging. These tests are required to verify proper system operation.



Tests or sections marked as "Tomosynthesis Option" and indicated by the  icon on the side of the page only apply to the breast tomosynthesis systems.



Sections indicated by the  icon on the side of the page only apply to the systems that are licensed to perform diagnostic procedures.



Sections marked as "CE2D Option" and indicated by the  icon on the side of the page only apply to the systems that are licensed to perform contrast enhanced digital mammography procedures.

### 1.2 Intended Use of the System Quality Control Manual

This quality control manual describes all quality assurance and control tests proposed by the manufacturer (Hologic, Inc.) for their digital mammography and breast tomosynthesis systems. Users of this manual should be the radiologic technologist and the medical physicist who are qualified to operate digital mammography and breast tomosynthesis systems.

#### **For Mammography Screen Facilities in the United States**

This manual must be used by facilities in the United States using digital mammography or breast tomosynthesis systems to establish a Quality Assurance and Quality Control program to conform to the rules of the United States Mammography Quality Standards Act (MQSA) or to become accredited by an accreditation body.

This manual can be substituted partially or to its entirety by new alternative standards approved to establish alternate Quality Assurance and Quality Control programs to conform to the rules of MQSA.

#### **For Mammography Screen Facilities Outside the United States**

Facilities that use the digital mammography or breast tomosynthesis systems and do not fall under the United States Mammography Standards Act (MQSA) should follow their local regulations for Quality Assurance and Quality Control. This manual may be used as a guide by these facilities to establish test protocols to conform to the applicable local regulations.

#### **Products, Modalities, and Software Versions Supported by this Manual**

This quality control manual supports these products:

- Selenia® Dimensions® mammography system
- 3Dimensions™ mammography system

This quality control manual supports these modalities:

- digital mammography (DM)
- breast tomosynthesis (BT)
- contrast enhanced digital mammography (CEDM)

This quality control manual supports these software levels:

- software versions 1.8 and later (refer to MAN-01965 for software versions prior to 1.8)



## 1.3 How to Use the Quality Control Manual

**Chapter 2—[Introduction](#)** on page 11: Facilities using x-ray systems other than screen-film mammography must maintain a QA/QC program substantially equivalent to the QA/QC program recommended by the manufacturer. This section lists the requirements that apply to the mammography system as specified by the manufacturer. Facilities that fail to follow the QA/QC program for the system as specified by the manufacturer in this Quality Control Manual may jeopardize their FDA/MQSA certification.

The MQSA Final Regulations mandate that the recommended QA/QC program for the system must be maintained *in addition to* the existing Quality Assurance and Quality Control programs for screen-film mammography.

**Chapter 3—[Quality Control Activities for the Medical Physicist](#)** on page 23: Specifies the Quality Control procedures, testing frequency, regulatory action levels and time limits for corrective action for each required Quality Control Activity that falls under the responsibility of the *medical physicist*. These Quality Control Activities performed by the medical physicist are required under MQSA Final Regulations or by the manufacturer of the Selenia Dimensions system. Detailed steps of how to perform the different tests are provided only for Quality Control procedures that are different from the standard Quality Control procedures already in use for screen-film mammography facilities. These detail steps are listed in this manual only to help guide the medical physicist as to how to perform the different tests on a system. **The medical physicist may deviate from the steps of the procedures listed in this chapter as long as the final outcome is in full compliance with the Recommended Performance Criteria and Corrective Action defined for each test.**

**Chapter 4—[Quality Control Activities for the Radiologic Technologist](#)** on page 83: This section specifies the Quality Control procedures, testing frequency, regulatory action levels and time limits for corrective action for each required Quality Control Activity that falls under the responsibility of the *radiologic technologist*. These Quality Control Activities performed by the radiologic technologist are required under MQSA Final Regulations or by the manufacturer. Detailed steps are provided only for Quality Control procedures that are different from the standard Quality Control procedures already in use for screen-film mammography facilities.

**Appendix A—[Quality Control Forms for the Medical Physicist](#)** on page 121: All forms necessary for the medical physicist's tests, including the medical physicist's Mammography Quality Control Test Summary, are provided here. The medical physicist may also use their own forms (i.e. electronic) that resemble the forms listed in this appendix.

**Appendix B—[Quality Control Forms for the Radiologic Technologist](#)** on page 171: Forms required for the Radiological Technologist's quality control of the system are provided here. The radiologic technologist may also use their own forms (i.e. electronic) that resemble the forms listed in this appendix.

**Appendix C**—[Dose Conversion Tables for the Medical Physicist](#) on page 205: Tungsten/rhodium (W/Rh), tungsten/silver (W/Ag), tungsten/aluminum (W/Al), and tungsten/copper (W/Cu) dose conversion tables are provided in this appendix for calculating average glandular (AGD) dose on a system. These dose conversion tables were derived for the filters used on the systems.

**Appendix D**—[CNR Correction Tables](#) on page 211: Tables for dose conversion for AEC Function Performance.

**Appendix E**—[Technique Tables](#) on page 225: Recommended manual technique tables for breast imaging using the system

## 1.4 Prerequisites

The procedures in this manual may call for the following documents:

- Hologic: *Selenia Dimensions System User Guide* or *3Dimensions System User Guide*

## 1.5 Change Summary

### Revision 001

Initial release

### Revision 002

- Added an icon to identify tests specific to the CE2D Option
- Expanded the following tests in the medical physicist section to allow for testing under the CE2D Option:
  - Artifact Evaluation
  - Beam Quality Assessment
  - Breast Entrance Exposure, AEC Reproducibility, and AGD
- Expanded the Artifact Evaluation test in the technologist section to allow for testing under the CE2D Option

### Revision 003

- Added a section describing the software versions supported by this manual
- Added CNR correction tables for:
  - Tomosynthesis Option (15 Projections, STANDARD Mode)
  - Tomosynthesis Option (15 Projections, ENHANCED)

### Revision 004

- Clarification of one step in the Radiological Technologist and Medical Physicist Test Procedures for DICOM Printer Artifact Evaluation. When doing the Printer Artifact Evaluation, the Print Site Info is automatically checked and should remain checked.

## Revision 005

- Corrected screen reference relating to Dose and AEC Reproducibility in Chapter 3 and in Tables 2, 3, and 40
- Clarified the note on Frequency for the DICOM Printer Quality Control test for the Radiological Technologist
- Revised Table 4 (Quality Control Activities for the Radiologic Technologist) to include Flat Field Calibration and removed Geometry Calibration
- Revised the corrective actions text in the Compression test for the Radiological Technologist
- Improved the layout and updated the test procedure for Signal-To-Noise and Contrast-To-Noise Measurements so the available options were made clearer. This change affected both the Medical Physicist and Radiological Technologist tests.
- Standardized terminology throughout the manual: "2D" and "FFDM" were replaced by "Digital Mammography (DM)", "Digital Breast Tomosynthesis (DBT)" was replaced by "Breast Tomosynthesis (BT)", and "Combo" mode was replaced by "DM + BT".

## Revision 006

- Added support for the 3Dimensions™ mammography system
- Added steps in several procedures so there is no longer a need to refer to the *1999 ACR Mammography Quality Control Manual* on how to execute a test
- Reformatted, consolidated, and added several forms to Appendix B for easier use and for no longer needing to refer to the *1999 ACR Mammography Quality Control Manual* for necessary forms
- Added a new section in Chapter 2 about the 2016 ACR QC Manual and Phantom Alternative Standard
- Added CNR Correction Tables for Tomo (30 Projections, Standard Mode) and Tomo (30 Projections, Enhanced Mode) in Appendix D
- Added CNR Correction Table for Tomo (15 Projections, Low Dose Mode) in Appendix D
- In Chapter 3, added a note about how to measure the accuracy of the compression breast thickness scale under the Quality Control Activities for the Medical Physicist
- Further clarifications were made to the Diagnostic Review Workstation Quality Control test for the Medical Physicist and Radiologic Technologist

## Revision 007

- Added information, procedures, and forms for the SmartCurve™ breast stabilization system
- Added clarification for use of flat compression paddles versus SmartCurve compression paddles
- Removed all references to permanent attachment of the acrylic disk to the phantom

### Revision 008

- Clarified the information regarding the ACR QC Manual and the new DBT tests and our preference for the continued use of the original phantom
- Clarified the procedure for Collimation Assessment with the SmartCurve paddle
- Removed an unnecessary form

### Revision 009

- Removed the EC Representative address and CE mark from the back cover, as it is no longer needed for this manual

### Revision 010

- Updated the (2018) ACR QC Manual and Phantom Alternative Standard section regarding the need to use the manufacturer's quality control manual for QC testing of advanced imaging modalities in addition to the testing performed according to the ACR Digital Mammography Quality Control Manual for the modalities approved by the FDA alternative standard
- Corrected Tables 13 and 35 to provide the proper settings for System Artifact Evaluation (CE2D Option) in the Medical Physicist and Radiological Technologist Test Procedures
- Added the type of paddles under Suggested Equipment for the Compression test for the Radiologic Technologist. Also, under Frequency, updated recommendation to: "Semiannually, or whenever *increased or reduced* compression is suspected"
- Clarified the test procedure for the Repeat/Reject Analysis for the Radiologic Technologist to indicate that the Repeat Analysis is done as separate steps from the Reject Analysis
- Corrected several "Record Forms" topics so the proper form in the Appendices is referenced
- Added an entry for the Combo mode AGD in the Medical Physicist's Mammography QC Test Summary form and added a "Filter" line in the 4. kVp Accuracy and Reproducibility form, both in Appendix A.
- Clarified the compression amount required in the Mammography Quality Control Checklist - DM and BT form in Appendix B
- Added several CNR correction tables/subsections in Appendix D:
  - Under CNR Correction - Conventional (Contact), added AEC Table 7 (Enhanced Uniform CNR Screening Dose)
  - Under CNR Correction - Tomosynthesis Option (15 Projections, STANDARD Mode), broke out separate AEC table sections *For Software Versions 1.8.2 – 1.9.x on Selenia Dimensions and 2.0.x on 3Dimensions* and *For Software Versions 1.10.x and above on Selenia Dimensions and 2.1.x and above on 3Dimensions*
  - Added a new CNR Correction Tables section for the Contrast Enhanced Biopsy Option

## 1.6 Terms and Definitions

Accession Number	A DICOM term that refers to a RIS generated number that uniquely identifies a visit to a site by a patient.
AEC	Automatic Exposure Control. A method of limiting the amount of radiation a patient will receive.
Ag	Silver
AGD	Average Glandular Dose.
Al	Aluminum
Biweekly	Every two weeks.
BT	Breast Tomosynthesis
C-View™	Hologic-generated digital mammogram (DM) image from data acquired during a breast tomosynthesis scan
CEDM	Contrast Enhanced Digital Mammography
CE2D	Hologic name for CEDM
Collimator	Device at the x-ray tube used to restrict the area of the receptor that is exposed.
Combo Mode	Hologic acquisition mode consisting of a traditional digital mammogram (DM) with a breast tomosynthesis (BT) scan under the same compression. Combo Mode is referred to as “DM + BT” in this manual.
Dialog Box	A pop-up which informs the user, may require a user decision, and requires the action of the user by mouse click or selection before any other activities can occur. It is used for important notices, warnings, and errors.
DICOM	Digital Imaging and Communications in Medicine. An industry standard specification for inter-communication between medical imaging equipment.
Digital Marker	A software implemented mechanism for imprinting a mark within an image to indicate some information, usually orientation.
DM	Digital Mammography
ESE	Entrance Skin Exposure
FAST Paddle™	Fully Automatic Self-Adjusting Tilt Paddle

# Quality Control Manual for Selenia Dimensions and 3Dimensions Systems

## Chapter 1: Prologue

---

Grid	Element within the Digital Image Receptor which reduces scatter radiation during exposure
HIS/RIS	Hospital Information System/Radiology Information System. Generic term for non-PACS systems that track patient demographics and ordered radiological studies.
HTC™	High Transmission Cellular Grid
HVL	Beam Quality Half-Value Layer
Image (Object)	A set of modality specific binary data and identifying attributes which represents the result of an imaging procedure performed on a patient. DICOM uniquely identifies image objects with a globally unique identifier (UID).
kVp	An electrical term used in setting x-ray exposure which stands for kilo-volt peak.
LFS	Large Focal Spot
Login/Logout	The process of logging into and out of the Operating System of the Acquisition Workstation. Upon start-up, this occurs before a user signs into the Acquisition Workstation application, and upon exiting, occurs after a user signs out of the Acquisition Workstation.
Mag	Magnification mode
mA	An electrical term used in setting x-ray exposure which stands for milliamperes
mAs	An electrical term used in setting x-ray exposure which stands for milliampere-seconds.
MQSA	Mammography Quality Standards Act
N	Newtons
OD	Optical Density
Operating System (OS)	The basic software control system which runs all functions of a computer.
Outputs	A list of devices the captured, accepted image will be sent to. Outputs consist of a combination of archives, workstations and film printers.

---

Procedure	A generic pre-defined medical protocol which contains a set of images (views) which are acquired under certain conditions, and are performed together for a singular purpose (e.g. standard screening). Because a procedure is a generic entity in DICOM, there is no procedure instance UID, but DICOM supports identification of requested procedures.
Rh or Rho	Rhodium
ROI	Region of Interest
Series	A set of images which have all been acquired by a single tech for a single patient and procedure on a particular modality with a fixed body part, laterality and view position. DICOM uniquely identifies series with a globally unique instance UID.
SFS	Small Focal Spot
SID	Source to Image Distance
Sign-in	The process of a user identifying him/herself to the Acquisition Workstation application.
Sign-out	The process of a user exiting the Acquisition Workstation application, but not logging out of the OS.
Technique	Combination of x-ray parameters (kV, mA, etc.) defined for a particular procedural view.
Tomosynthesis (Tomo)	An imaging technique that recombines a number of breast images taken at different angles through the breast to achieve various effects. Tomosynthesis images can be reconstructed to show planes or slices within the breast.
View	The combination of a single x-ray image and a specific set of conditions under which the image was acquired. View is not part of DICOM nomenclature, but in the context of DR, is approximately synonymous with a DICOM image object.
Visit	A set of studies identified in a locally unique manner and performed on a particular patient at a particular site for a singular reason. A visit is normally identified by an accession number or a Visit ID and is associated with a diagnosis. DICOM has no concept of a visit instance UID.
W	Tungsten

---

## 1.7 Descriptions of Warnings, Cautions, and Notes

Descriptions of Warnings, Cautions, and Notes used in this manual:



---

---

**WARNING!**

**The procedures that you must follow accurately to prevent possible dangerous or fatal injury.**

---

---



---

**Warning:**

**The procedures that you must follow accurately to prevent injury.**

---



---

**Caution:**

**The procedures that you must follow accurately to prevent damage to equipment, loss of data, or damage to files in software applications.**

---



---

**Note**

Notes show additional information.

---



## Chapter 2 Introduction

A facility using the system must establish a Quality Assurance and Quality Control program substantially equivalent to the Quality Assurance and Quality Control program recommended by the manufacturer—Hologic. The Quality Assurance and Quality Control program recommended for the system is described in this Quality Control Manual. All facilities in the United States that use the system must follow this Quality Control Manual in order to conform to MQSA Final Regulations and not jeopardize their FDA/MQSA certification or accreditation. Facilities outside the United States may follow this Quality Control Manual to establish a Quality Assurance and Quality Control program for the system according to the manufacturer’s recommendations.

### 2.1 Personnel Training

MQSA Final Regulations require that personnel must receive appropriate training before they qualify to use digital mammography or breast tomosynthesis systems. Facilities using a digital mammography system require training in digital mammography. Facilities using the breast tomosynthesis system require training in both digital mammography and breast tomosynthesis modalities. Required training is as follows:

#### 2.1.1 Required Training in Digital Mammography

##### **Medical Physicist**

Before a medical physicist may begin independently performing mammography surveys on digital mammography systems, the physicist must have received at least eight hours of training in the digital mammography modality.

##### **Radiologic Technologist**

Before a radiologic technologist may begin independently performing digital mammographic imaging procedures, the technologist must have met all appropriate MQSA personnel requirements including having at least eight hours of continuing education units in digital mammography.

##### **Interpreting Physician**

Before an interpreting physician may begin independently interpreting digital mammograms, the interpreting physician must have met all appropriate MQSA personnel requirements including having at least eight hours of training in digital mammography.

### 2.1.2 Required Training in Breast Tomosynthesis

#### Medical Physicist

Before a medical physicist may begin independently performing mammography surveys on breast tomosynthesis systems, the physicist must have received at least eight hours of training in the breast tomosynthesis modality.

#### Radiologic Technologist

Before a radiologic technologist may begin independently performing breast tomosynthesis imaging procedures, the technologist must have at least eight hours of training in the breast tomosynthesis modality.

#### Interpreting Physician

Before an interpreting physician may begin independently interpreting breast tomosynthesis images, the interpreting physician must have at least eight hours of training in the breast tomosynthesis modality.

## 2.2 Responsibilities

### 2.2.1 Medical Physicist

It is the responsibility of the medical physicist to carry out the system Equipment Evaluations before clinical use commences after the equipment is first installed, moved, or significantly modified-see CFR 900.12(e)(10). The system Equipment Evaluations must include all Quality Control tests listed under both Quality Control Activities for the Medical Physicist and Quality Control Activities for the Radiologic Technologist in accordance to 900.12(b) and 900.12(e) where applicable. For the installation of a new Selenia Dimensions or 3Dimensions system, the applicable tests in Section 900.12(b) are listed in Appendix A.

In the event of system software upgrades, the list of tests required to be performed by either the medical physicist or the technologist will be given in the release notes describing the corresponding software changes according to the alternative standard described in section 2.3.

The upgrade of a Selenia Dimensions or 3Dimensions DM system to a BT system is considered to be a significant modification to the system. The upgrade to the CEDM (I-View) capability is also considered to be a significant modification to the system. In the event of such upgrades to an existing system, the medical physicist is required to perform a full equipment evaluation after the upgrade as per the [table](#) on page 13.

The medical physicist must provide operating levels and control limits to the technologist for the Quality Control tests pertaining to the radiologic technologist, where appropriate, e.g., CNR Test. Such operating levels and control limits must follow the guidelines of this Quality Control Manual.

The medical physicist is also responsible to perform all Quality Control tests listed under Quality Control Activities for the medical physicist at least annually and monitor the overall Quality Assurance and Quality Control program for the system.

The medical physicist must review the results of the technologist’s Quality Control tests at least annually. The results of the overall Quality Assurance and Quality Control program must be reviewed by the medical physicist with the responsible interpreting physician at least annually.

*Table 1: Medical Physicist Installation Quality Control Tests*

<b>Quality Control Tests To Be Performed by the Medical Physicist Upon Installation (MEE)</b>
Mammographic Unit Assembly Evaluation
Collimation Assessment
Artifact Evaluation
kVp Accuracy & Reproducibility
Beam Quality Assessment – HVL
Evaluation of System Resolution
AEC Function Performance
Breast Entrance Exposure, AEC Reproducibility and Average Glandular Dose
Radiation Output Rate
Phantom Image Quality Evaluation
Signal to Noise and Contrast to Noise
Diagnostic Review Workstation Quality Control
DICOM Printer Quality Control (Radiologic Technologist section)
Detector Flat Field Calibration (Radiologic Technologist section)
Geometry Calibration for Tomosynthesis Option (Radiologic Technologist section)
Compression Thickness Indicator (Radiologic Technologist section)
Compression (Radiologic Technologist section)

### 2.2.2 Radiologic Technologist

It is the responsibility of the radiologic technologist to carry out the Quality Control tests listed in the Quality Control Activities for the Radiologic Technologist at the specified frequency, review the results and request timely corrective action as necessary. The technologist must review the Quality Control results with the medical physicist and supervising interpreting physician at least annually and consult with the medical physicist any time there are questions about the procedure or the results of these Quality Control tests.

In the event of system software upgrades, the list of tests required to be performed by either the medical physicist or the technologist will be given in the release notes describing the corresponding software changes according to the alternative standard described in section 2.3.

### 2.2.3 Interpreting Physician

The supervising interpreting physician must review the results of the quality control program with the medical physicist and radiologic technologist at least annually.

### 2.2.4 Facility

As is the case for screen-film Quality Control, the facility must keep records of all Quality Control Activities and all applicable corrective actions for at least 12 months since the last annual inspection which verified compliance (until the next physicist's and inspector's visits), or until the test has been done two additional times at the required frequency, whichever is longer. If the test results exceed the control limits, corrective action must be taken within time frames as specified for each Quality Control test in this Quality Control Manual. The facility is also responsible to follow the QC instructions given in the release notes of performed software upgrades and notify the medical physicist to have the opportunity to review the QC test results.

## 2.3 Alternative Quality Control Standard

### 2.3.1 Alternative Standard 6



#### Note

The information provided below is derived from specific sections of the FDA's published Approved Alternative Requirements and is provided as a reference only. For the complete text, go to <http://www.fda.gov/Radiation-EmittingProducts/MammographyQualityStandardsActandProgram/Regulations/ucm110880.htm>.

---

Federal regulations, 900.12(e)(10), specify that additional evaluations of mammography units must be conducted after major component changes or repairs. Software changes or upgrades are considered by the FDA to be major repairs, thus the facility must have a mammography equipment evaluation performed after installation of such a change or upgrade. The mammography equipment evaluation must be performed and all failures to meet the applicable standards must be corrected before the affected equipment is used for patient examinations. The tests to be included in the mammography equipment evaluation must be specified by the manufacturer and must meet the following conditions:

1. The specified tests must be adequate for determining whether all of the standards of 21 CFR 900.12(b) and (e) that are applicable to the upgrade are met.
2. All the tests included in the mammography equipment evaluation must be either tests that are performed by the quality control technologist as part of the quality assurance program required by the manufacturer, or tests specific to the upgrade which are of no greater complexity than those performed by the quality control technologist as part of the quality assurance program required by the manufacturer.
3. None of the necessary tests after the software upgrade are required to be performed by the medical physicist.

Additional conditions for using this alternative requirement in association with a software upgrade are that:

4. The manufacturer must notify FDA of its intention to install the upgrade. The notification must include a brief description of the upgrade, the model(s) of the units that will be upgraded, a list of the post installation tests that the facility needs to perform, and a copy of the information to be provided to each facility describing the upgrade and the facility's post installation responsibilities.
5. The manufacturer must confirm in the notification to FDA that the tests to be performed for the mammography equipment evaluation are either tests that are performed by the quality control technologist as part of the quality assurance program required by the manufacturer or tests specific to the upgrade which are of no greater complexity than those performed by the quality control technologist as part of that quality assurance program.
6. The manufacturer must confirm that none of the required tests must be performed by a medical physicist.
7. The manufacturer must receive an acknowledgement from FDA of receipt of the upgrade notification before beginning the upgrade installation.
8. By the completion of each individual upgrade, the manufacturer must inform the facility in writing of its post installation responsibilities under the alternative requirement, which are that the facility must:
  - Conduct a mammography equipment evaluation after installation of the upgrade, either during a medical physicist onsite visit or under Medical Physicist Oversight.
  - Include in its mammography equipment evaluation the tests specified by the manufacturer.

- Perform the mammography equipment evaluation and correct all test failures before the affected equipment is used for patient examinations.
- Keep records of the test results and follow-up actions in accordance with 21 CFR 900.12(d)(2).

If all the above (1-8) conditions are met, then the mammography equipment evaluation may be conducted either during an onsite visit by a medical physicist or under Medical Physicist Oversight. If any of the necessary tests after the software upgrade are required to be performed by the medical physicist, the mammography equipment evaluation must be performed in its entirety by the medical physicist on site.

FDA's acknowledgement as stated in item 7 above does not constitute approval of the type of testing of the software upgrade in question. FDA will contact the manufacturer if any issues arise concerning the upgrade in question. As a result, FDA may disallow testing the software upgrade under Medical Physicist Oversight if it determines that one or more of the above conditions were not met.

### 2.3.2 Alternative Standard 9

Federal regulations, 900.12(e), specify that any time quality control test results fall outside of the action limits for systems with image receptor modalities other than screen-film, the source of the problem must be identified and corrective action must be taken before any further examinations are performed.

If any test results fall outside the action limits according to this Alternative Standard, three different action categories apply:

**Category A:** If any of the following quality control tests that evaluate the performance of the *image acquisition components* of the system produces results that fall outside the action limits as specified by the manufacturer, the source of the problem must be identified and corrective action must be taken before any further examinations are performed.

Applicable Quality Control tests:

1. Evaluation of System Resolution
2. Breast Entrance Exposure and Average Glandular Dose
3. Phantom Image Quality Evaluation (Medical Physicist)
4. Phantom Image (Radiologic Technologist)
5. Signal-to-Noise and Contrast-to-Noise Measurements
6. Detector Ghosting
7. Detector Flat Field Calibration
8. Geometry Calibration (Tomosynthesis Option)
9. Compression
10. Post-Move and Pre-Examination Tests for Mobile Systems

**Category B:** If any of the following quality control tests that evaluate the performance of a *diagnostic device used for mammographic image interpretation* (i.e. DICOM printer, physician's review station) produces results that fall outside the action limits as specified

by the manufacturer, the source of the problem must be identified and corrective action must be taken before that device can be used for mammographic image interpretation. Clinical imaging can be continued and alternative approved diagnostic devices must be used for mammographic image interpretation.

Applicable Quality Control tests:

1. Phantom Image Quality Evaluation (Medical Physicist)
2. Phantom Image (Radiologic Technologist)
3. Diagnostic Review Workstation Quality Control
4. DICOM Printer Quality Control
5. Viewboxes and Viewing Conditions (Radiologic Technologist)

**Category C:** If any of the following quality control tests that evaluate the performance of components other than the digital image receptor or the diagnostic devices used for mammographic image interpretation produces results that fall outside the action limits as specified by the manufacturer, the source of the problem must be identified and corrective action must be taken within thirty days of the test date. Clinical imaging and mammographic image interpretation can be continued during this period.

Applicable Quality Control tests:

1. Mammographic Unit Assembly Evaluation
2. Collimation Assessment
3. Artifact Evaluation
4. kVp Accuracy and Reproducibility
5. Beam Quality Assessment – HVL Measurement
6. Automatic Exposure Control (AEC) Function Performance
7. Automatic Exposure Control (AEC) Reproducibility
8. Radiation Output Rate
9. Viewbox Luminance and Room Illuminance (Radiologic Technologist)
10. Compression Thickness Indicator
11. Visual Checklist
12. Repeat/Reject Analysis

### 2.3.3 2018 ACR QC Manual and Phantom Alternative Standard

Until recently, the FDA required digital mammography facilities to perform QC for approved imaging systems according to their respective manufacturers' quality control manuals. In February 2016, however, the FDA approved the ACR's new Digital Mammography Quality Control (QC) Manual and Digital Mammography QC Phantom as an alternative standard for use in routine QC of digital mammography equipment. In 2018, the FDA approved the ACR's digital breast tomosynthesis (DBT) tests for incorporation into the 2016 ACR Digital Mammography Quality Control Manual. This approval, as an alternative standard, allows mammography facilities, including QC technologists and medical physicists, to use the new ACR manual in lieu of manufacturers' quality control manuals. If a facility is interested in adopting the recently approved alternative standard that allows use of the new ACR QC manual and phantom, the facility needs to consider the following:

1. The ACR Digital Mammography Quality Control Manual does not include QC instructions for contrast enhancement imaging. The manufacturer's quality control manual needs to be used for QC testing of advanced imaging modalities in addition to the testing performed according to the ACR Digital Mammography Quality Control Manual for the modalities approved by the FDA alternative standard.
2. A unified QC program needs to be established across each facility. If a facility cannot use the new ACR QC manual for all full-field digital mammography and DBT systems under its QC umbrella, then the facility needs to resort to the manufacturer's QC manual.
3. The new ACR QC phantom is not compatible with the Hologic's QC manual. If a facility uses the Hologic's QC manual, then the facility needs to use the traditional ACR phantom (original).



#### Note

Although the Hologic QC manual requires the original ACR phantom, the latest software revisions (software revisions 1.10 and above for Selenia Dimensions systems and software revisions 2.1 and above for 3Dimensions systems) do provide the capability for automated Signal to Noise Ratio and Contrast to Noise Ratio calculations (SNR/CNR test) with the new ACR QC phantom under the ACR Phantom Conv view. See Section 3.11.4 of this manual under the Automatic ROI Creation section for details.

---



## 2.4 Quality Control Activities for the Medical Physicist

The following table lists the Quality Control tests to be performed by a qualified medical physicist at the specified frequency. These tests cover Selenia Dimensions and 3Dimensions Digital Mammography (DM) and Breast Tomosynthesis (BT) systems. All tests listed in the following table describe the tests and procedures to be followed when testing a DM or BT system. The [table](#) on page 20 lists a subset of the QC tests from the following table that have specific actions for performing quality control activities on a Selenia Dimensions or 3Dimensions BT system. The medical physicist performing the Quality Control Activities for the DM or BT systems must have met all appropriate MQSA personnel requirements as described in [Personnel Training](#) on page 11 of this chapter.

Table 2: Quality Control Tests to Be Performed by the Medical Physicist on Selenia Dimensions and 3Dimensions DM and BT Systems

Quality Control Test	Frequency	Action Criteria	Section Title
Mammographic Unit Assembly Evaluation	Annually	Category C	<a href="#">Mammographic Unit Assembly Evaluation</a> on page 25
Collimation Assessment	Annually	Category C	<a href="#">Collimation Assessment</a> on page 26
Artifact Evaluation	Annually	Category C	<a href="#">Artifact Evaluation</a> on page 37
kVp Accuracy and Reproducibility	Annually	Category C	<a href="#">kVp Accuracy and Reproducibility</a> on page 44
Beam Quality Assessment—HVL Measurement	Annually	Category C	<a href="#">Beam Quality Assessment—Half-Value Layer Measurement</a> on page 46
Evaluation of System Resolution	Annually	Category A	<a href="#">Evaluation of System Resolution</a> on page 49
Automatic Exposure Control (AEC) Function Performance	Annually	Category C	<a href="#">Automatic Exposure Control (AEC) Function Performance</a> on page 52
Dose and AEC Reproducibility	Annually	Category A Category C	<a href="#">Breast Entrance Exposure, AEC Reproducibility, and AGD</a> on page 57
Radiation Output Rate	Annually	Category C	<a href="#">Radiation Output Rate</a> on page 63
Phantom Image Quality Evaluation	Annually	Category A	<a href="#">Phantom Image Quality Evaluation</a> on page 66
Signal-To-Noise and Contrast-To-Noise Measurements	Annually	Category A	<a href="#">Signal-To-Noise and Contrast-To-Noise Measurements</a> on page 103
Diagnostic Review Workstation Quality Control	Annually	Category B	<a href="#">Diagnostic Review Workstation Quality Control</a> on page 76
Detector Ghosting (troubleshooting use only)	—	Category A	<a href="#">Detector Ghosting (Troubleshooting Use Only)</a> on page 79

# Quality Control Manual for Selenia Dimensions and 3Dimensions Systems

## Chapter 2: Introduction

Table 3: Quality Control Tests with Tomosynthesis-Specific Options



Quality Control Test	Frequency	Action Criteria	Section Title
Collimation Assessment	Annually	Category C	<a href="#">Collimation Assessment</a> on page 26
Artifact Evaluation	Annually	Category C	<a href="#">Artifact Evaluation</a> on page 37
Beam Quality Assessment—HVL Measurement	Annually	Category C	<a href="#">Beam Quality Assessment—Half-Value Layer Measurement</a> on page 46
Evaluation of System Resolution	Annually	Category A	<a href="#">Evaluation of System Resolution</a> on page 49
Automatic Exposure Control (AEC) Function Performance	Annually	Category C	<a href="#">Automatic Exposure Control (AEC) Function Performance</a> on page 52
Dose and AEC Reproducibility	Annually	Category A Category C	<a href="#">Breast Entrance Exposure, AEC Reproducibility, and AGD</a> on page 57
Phantom Image Quality Evaluation	Annually	Category A	<a href="#">Phantom Image Quality Evaluation</a> on page 66



**Note**

Steps within a QC test labeled "Tomosynthesis Option" are only performed on Selenia Dimensions or 3Dimensions BT systems.

## 2.5 Quality Control Activities for the Radiologic Technologist

The following table lists the Quality Control tests to be performed by a qualified radiologic technologist at the specified frequency. These tests cover DM and BT systems. All tests listed in the following table describe the tests and procedures to be followed when testing a DM or BT system. The [table](#) on page 22 lists a subset of the QC tests from the following table that have specific actions for performing quality control activities on a BT system. The radiologic technologist performing the Quality Control Activities for DM or BT systems must have met all appropriate MQSA personnel requirements as described in [Personnel Training](#) on page 11 of this chapter.

Table 4: Quality Control Tests to Be Performed by the Radiologic Technologist on Selenia Dimensions and 3Dimensions DM and BT Systems

Quality Control Test	Frequency	Action Criteria	Section Title
DICOM Printer Quality Control	Weekly	Category B	<a href="#">DICOM Printer Quality Control</a> on page 85
Detector Flat Field Calibration	Weekly	Category A	<a href="#">Detector Flat Field Calibration</a> on page 89
Artifact Evaluation	Weekly	Category C	<a href="#">Artifact Evaluation</a> on page 94
Phantom Image	Weekly	Category A	<a href="#">Phantom Image</a> on page 100
Signal-To-Noise and Contrast-To-Noise Measurements	Weekly	Category A	<a href="#">Signal-To-Noise and Contrast-To-Noise Measurements</a> on page 103
Compression Thickness Indicator	Biweekly	Category C	<a href="#">Compression Thickness Indicator</a> on page 110
Diagnostic Review Workstation Quality Control	Weekly	Category B	<a href="#">Diagnostic Review Workstation Quality Control</a> on page 76
Viewboxes and Viewing Conditions	Weekly	Category B	<a href="#">Viewboxes and Viewing Conditions</a> on page 115
Visual Checklist	Monthly	Category C	<a href="#">Visual Checklist</a> on page 116
Repeat/Reject Analysis	Quarterly	Category C	<a href="#">Repeat/Reject Analysis</a> on page 117
Compression	Semiannually	Category A	<a href="#">Compression</a> on page 119

*Table 5: Quality Control Tests with Tomosynthesis-Specific Options*



Quality Control Test	Frequency	Action Criteria	Section Title
Geometry Calibration (Tomosynthesis Option)	Semiannually	Category A	<a href="#">Geometry Calibration (Tomosynthesis Option)</a> on page 92
Artifact Evaluation	Weekly	Category C	<a href="#">Artifact Evaluation</a> on page 94
Phantom Image	Weekly	Category A	<a href="#">Phantom Image</a> on page 100



**Note**

Steps within a QC test labeled "Tomosynthesis Option" are only performed on Selenia Dimensions or 3Dimensions BT systems.

**2.5.1 Mobile System Quality Control Checks**

The following checks must be performed and results recorded each time the system is relocated and before any patient examinations are performed:

- Compression Thickness
- Artifact Evaluation
- Phantom Image Evaluation
- Signal-to-Noise and Contrast-to-Noise

## Chapter 3 Quality Control Activities for the Medical Physicist

This section specifies the Quality Control procedures, regulatory action levels and time limits for corrective action for each required Quality Control Activity that falls under the responsibility of the medical physicist. Detailed steps are provided only for Quality Control procedures that are different from the standard Quality Control procedures already in use for screen-film mammography facilities. Detailed steps for procedures have been provided in summary here. These detailed steps are listed in this manual only to help guide the medical physicist as to how to perform the different tests on a system. **The medical physicist may deviate from the steps of the procedures listed in this chapter as long as the final outcome is in full compliance with the Recommended Performance Criteria and Corrective Action defined for each test.**

All tests under the *Quality Control Activities for the Medical Physicist* section of this manual must be performed at least annually by a qualified medical physicist trained according to [Personnel Training](#) on page 11 in this manual. The logs of the *Quality Control Activities for the Radiologic Technologist* section of this manual must be reviewed by the medical physicist at least annually.



**Note**

Please read the *User Guide* to become familiar with the basic interface of the system before using the system.



**Note**

Quality Control activities are organized in the system application for medical physicist and radiologic technologist, respectively. The medical physicist and the radiologic technologist should go to the Quality Control list at **Admin>Quality Control** and select the procedure to be performed. The procedure from the Quality Control list is configured to provide the proper image views and acquisition techniques that are needed for the selected test. A Physicist account is available on the system to aid in performing the Medical Physicist quality control tests without interfering with the clinical data of the system.



**Note**

Any steps in the QC test procedures that are specific to breast tomosynthesis are

indicated by the wording "Tomosynthesis Option" and the  icon on the side of the page. Such steps only apply to systems that are licensed to perform tomosynthesis procedures.

# Quality Control Manual for Selenia Dimensions and 3Dimensions Systems

## Chapter 3: Quality Control Activities for the Medical Physicist

---

**D<sub>x</sub>**



**Note**

Any steps in the QC test procedures that make use of the SFS are indicated by the icon on the side of the page. Such tests only apply to systems that are licensed to perform diagnostic procedures.

---

**D<sub>x</sub>**



**Note**

Any steps in the QC test procedures that are specific to contrast enhanced digital

mammography are indicated by the wording “CE2D Option” and the  icon on the side of the page. Such steps only apply to systems that are licensed to perform contrast enhanced digital mammography procedures.

---



**Note**

Before performing an image quality test, the system must change status from Detector Warming to All Ready.

---



**Caution:**

Direct exposure of the digital detector to high radiation dose may damage the detector. The digital image receptor must be covered with lead during testing for exposures other than those required to qualify image quality. Following the test procedures in this Quality Control Manual will ensure the safety of the digital detector.

---

### 3.1 Mammographic Unit Assembly Evaluation

#### 3.1.1 Objective

To ensure good and safe working conditions of all interlocks, mechanical detents and safety switches, and to ensure mechanical integrity of the x-ray tube and digital image receptor assembly.

#### 3.1.2 Frequency

Annually

#### 3.1.3 Test Procedure

1. Refer to the Mammography Equipment Evaluation form provided in Appendix A and evaluate all items on the list.
2. Select **Admin>QC>Physicist tab>Mammography Unit Assembly Evaluation** procedure on the Acquisition Workstation.
3. Select the **Mark Completed** button to label the status of this procedure as finished. Select the **Yes** button to mark the Quality Control procedure as completed.

#### 3.1.4 Record Forms

Use the "Mammography Unit Assembly Evaluation" form in Appendix A to record the results.

#### 3.1.5 Data Analysis and Interpretation

None.

#### 3.1.6 Recommended Performance Criteria and Corrective Action

The system must perform according to the requirements outlined in the Mammography Equipment Evaluation Form.

If the recommended performance criteria are not met, the source of the problem must be identified and corrective action must be taken within thirty days of the test date.



#### Note

Accuracy of the compression breast thickness scale shall be conducted according to the "Compression Thickness Indicator" test procedure listed in this QC manual under the Quality Control Activities for the Radiologic Technologist.

---

## **3.2 Collimation Assessment**

### **3.2.1 Objective**

To assure that:

- The x-ray field coincides with the light field
- The x-ray field is aligned with the image receptor
- The chest wall edge of the screening compression paddles is aligned with the chest wall edge of the digital image receptor

### **3.2.2 Frequency**

Annually

### **3.2.3 Suggested Equipment**

- X-ray recording media
- All available screening compression paddles (for example, 24 × 29 cm flat compression paddle)
- 4.0 cm of BR-12 or PMMA
- Four small attenuators, i.e., coins of one size (for example, four pennies)
- Ruler or measuring tape



**Note**

Please note that use of self-developing film may require high exposures. It is recommended that you cover the digital detector with 0.5 mm lead, or you may make multiple typical exposures instead of a single high exposure.

---



**Note**

Evaluation of SmartCurve™ compression paddle to image receptor alignment only applies to systems licensed for the SmartCurve breast stabilization system.

---



### 3.2.4 Test Procedure

#### X-Ray to Light Field to Image Receptor Alignment

---



**Note**

Evaluation of the x-ray to light field alignment needs to be performed only for the 24 x 29 cm field. The deviation between the light field and x-ray field remains constant as collimation size changes.

---

1. Select **Admin>Quality Control>Physicist tab>Collimation Assessment** on the Acquisition Workstation. Select the **Start** button.
  2. Install the 24 × 29 cm flat compression paddle in the compression device to activate the x-ray tube collimation system.
  3. Raise the compression paddle to approximately 15 cm as indicated by the thickness display on the compression device.
  4. Turn the collimator light On and place the x-ray recording media on top of the image receptor to cross the four sides of the light field. Make sure that the x-ray recording media extend beyond the digital image receptor enclosure at the chest wall.
- 



**Note**

If radiographic or CR cassettes are used, the tube side of the cassette(s) should face the x-ray source. In the case where one cassette is used, the chest wall side of the cassette should point towards the chest wall side of the digital image receptor. In the case where two cassettes are used, the chest wall side of each cassette should run across the lateral centerline of the digital image receptor.

---

5. Place the four attenuators one on each side of the detector. If x-ray recording media are used, place the attenuators on top of the recording media, otherwise place them directly on the detector surface.
  6. Turn the collimator light ON and move the four attenuators inside the light field and on top of the x-ray recording media with one edge of each attenuator just touching the edge of the light field (middle of the penumbra).
- 



**Note**

You can use the manual collimation control on the side of the C-arm to select any collimation field without having to install the appropriate paddle first. Absence of the compression paddle may allow for better definition of the light penumbra.

---

7. Move the compression paddle 4.2 cm from the image receptor as indicated by the thickness display on the compression device.
8. Select the first **Flat Field Conv** view from the Procedure screen on the Acquisition Workstation. Make sure that the collimation size displayed on the tubehead is correct.

9. Acquire a manual exposure:

*Table 6: Collimation Assessment Exposure Techniques*

Mode	kVp	mAs	Filter	Focal Spot
Manual	25	30	Rh	Large

*Table 7: Collimation Assessment Exposure Techniques  
(Tomosynthesis Option)*

Mode	kVp	mAs	Filter	Focal Spot
Manual	25	30	Al	Large



**Note**

The suggested techniques may work well with screen-film cassettes. When different x-ray media are used, the techniques may be adjusted accordingly to generate a recordable image. An attenuator may be used to protect the detector from potential use of high exposure techniques.

---

10. Select the **Accept** button to accept the image in the Procedure screen on the Acquisition Workstation.
11. Remove the x-ray recording media at this point and process any film or CR plates, if needed.



**Note**

You do not need to use x-ray recording media for the rest of this procedure.

---

12. Replace the 24 × 29 cm flat compression paddle with the 18 × 24 cm flat compression paddle.
13. Select the second **Flat Field Conv** view for the left imaging position.
  - a. Shift to the left using the Paddle Shift feature on the compression device or the Procedure screen.
  - b. Repeat Step 5 through Step 10 without using the x-ray recording media.
14. Select the third **Flat Field Conv** view for the center position.
  - a. Shift to the center using the Paddle Shift feature on the compression device or the Procedure screen.
  - b. Repeat Step 5 through Step 10 without using the x-ray recording media.

15. Select the fourth **Flat Field Conv** view for the right position.
  - a. Shift to the right using the Paddle Shift feature on the compression device or the Procedure screen.
  - b. Repeat Step 5 through Step 10 without using the x-ray recording media.
16. Select the **Zero-Degree Tomo** view for the center position (Tomosynthesis Option). Add the view if necessary.
  - a. Shift to the center using the Paddle Shift feature on the compression device or the Procedure screen.
  - b. Repeat Step 5 through Step 10 without using the x-ray recording media and using the Zero-Degree Tomo view instead of the **Flat Field Conv** view in step 8.

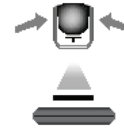

### Flat Compression Paddle to Image Receptor Alignment



**Note**

Compression paddle to image receptor alignment must be tested for all screening paddles. This includes the flat 18 x 24 cm paddle, flat 24 x 29 cm paddle, and the small breast compression paddle, as well as the 18 x 24 cm and 24 x 29 cm SmartCurve paddles.

1. Center the 4.0 cm BR-12 or PMMA phantom laterally on the image detector and assure that the front edge of the phantom extends slightly beyond the front cover of the detector platform.
2. Install the 24 x 29 cm flat compression paddle on the compression device.
3. Tape an attenuator inside the compression paddle and assure that the outer edge of the attenuator is tangent to the inner lip of the chest wall side of the compression paddle.
4. Lower the compression device until the paddle touches the BR-12 or PMMA phantom.
5. Apply between 10 lb and 12 lb of compression to the BR-12 or PMMA phantom.



**Note**

Compression force must be applied to ensure proper results for this test.

6. Select the next **Flat Field Conv** view from the Procedure screen on the Acquisition Workstation.
7. Acquire a manual exposure:

*Table 8: Compression Paddle Alignment Exposure Techniques*

Mode	kV	mAs	Filter	FS
Manual	28	100	Rh	Large

8. Select the **Accept** button to accept the image in the Procedure screen on the Acquisition Workstation.
9. Repeat steps 2 through 8 for all flat screening compression paddles. These paddles need to be tested in the center position only.

### SmartCurve Compression Paddle to Image Receptor Alignment

---

**Note**

The following procedure only applies to systems that use the SmartCurve compression paddles.

---

**Note**

Using an attenuator may not be applicable to the SmartCurve paddles. A different method may be more appropriate when testing a SmartCurve compression paddle.

---

1. Install the 18 x 24 cm flat screening paddle on the compression device.
  2. Using a ruler or measuring tape, measure the distance from the front of the compression device to the inner lip of the chest wall side of the flat compression paddle. (See the figure [Example of measurement of the SmartCurve paddle](#) on page 31 for an example.) Record the results as "Ruler Measurement (corresponding flat)" in the record form.
  3. Remove the flat screening paddle.
  4. Install the 18 x 24 cm SmartCurve compression paddle.
  5. Using a ruler or measuring tape, measure the distance from the front of the compression device to the inner lip of the chest wall side of the SmartCurve compression paddle. (Use the same location for measuring as you used for step 2.) Record the results as "Ruler Measurement (curved)" in the record form.
- 

**Note**

The SmartCurve compression paddles have been designed to match the overall dimensions of their corresponding flat screening compression paddles. If the SmartCurve paddles appear to extend significantly beyond the corresponding flat paddle's position, ensure that the measurement tool is level so that there is no tilting of the tool that may skew the results.

---

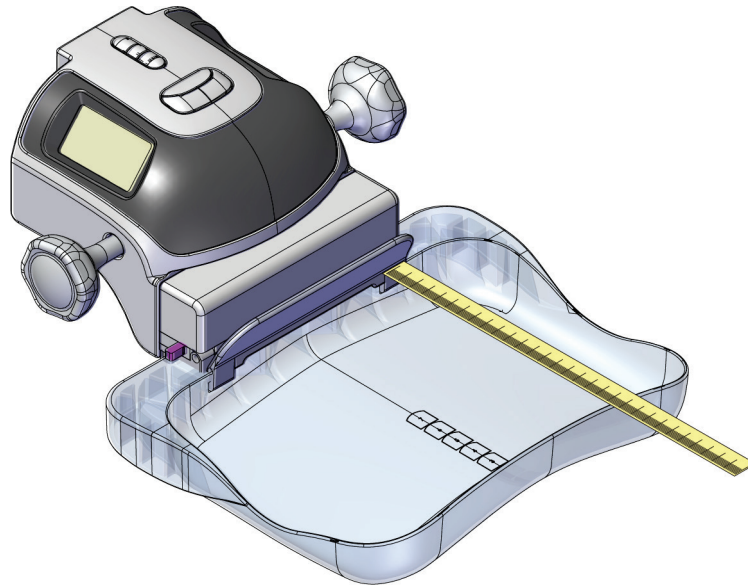

Figure 1: Example of measurement of the SmartCurve paddle

6. Center the 4.0 cm BR-12 or PMMA phantom laterally on the image detector and assure that the front edge of the phantom extends slightly beyond the front cover of the detector platform.
7. Lower the compression device until the paddle touches the BR-12 or PMMA phantom.
8. Apply between 10 lb and 12 lb of compression.



**Note**

Compression force must be applied to ensure proper results for this test.

9. Select a **Flat Field Conv** view from the Procedure screen on the Acquisition Workstation.
10. Acquire a manual exposure:

Table 9: Compression Paddle Alignment Exposure Techniques

Mode	kV	mAs	Filter	FS
Manual	28	100	Rh	Large

11. Select the Accept button to accept the image from the Procedure screen on the Acquisition Workstation.
12. Repeat steps 1 through 11 with the 24 x 29 cm flat screening paddle and the 24 x 29 cm SmartCurve compression paddle.
13. Move to the "Data Analysis and Interpretation" section.
14. Select the **End QC** button to mark the Quality Control procedure as completed when you are done with data analysis and interpretation.

### 3.2.5 Record Forms

Use the "Collimation Assessment" form in Appendix A to record the results.

### 3.2.6 Data Analysis and Interpretation

#### X-Ray Field to Light-Field Coincidence

1. On the x-ray recording media, measure the physical deviation between the x-ray field and the edge of the light field (defined by the exterior edges of the four attenuators). Record the measured deviations between the x-ray field and light field on the record form for the 24 x 29 cm collimation.



#### Note

You should maintain a positive sign "+" if the x-ray field extends beyond the light field and a negative sign "-" if the x-ray field falls inside the light field.

---

2. Correct the physical measurements by multiplying the measured distance by the geometric magnification factor  $f_{(geom)}$ . The magnification factor can be determined by  $f_{(geom)} = 70.0 / (67.5 - \text{height})$  where "height" is the distance between the top of the breast support platform and the bottom of the attenuator.
3. Add the magnitude of the corrected deviations at the left and right edges of the image receptor disregarding any signs. Record the total deviation on the record form.
4. Add the magnitude of the corrected deviations at the anterior and posterior edges of the image receptor disregarding any signs. Record this value on the record form.
5. Compute the percent deviation with regards to the SID for the above results.

### X-Ray Field to Image Receptor Alignment

1. Select the first **Flat Field Conv** thumbnail image in the Procedure screen on the Acquisition Workstation to display in the Preview screen. Recall that this corresponds to the 24 × 29 cm imaging mode.



Figure 2: Preview Image with Measurements

2. The edges of the preview image represent the boundaries of the image receptor. Use the distance-measuring tool to measure all four distances from the edge of the image to the inner edge of each attenuator in the preview window as illustrated in the previous figure and record the numbers as "Preview Measurement" in the record form. Start from the edge of the image moving inwards to assure that the measurement numbers will be displayed on the image window.
3. Correct the "Preview Measurements" by multiplying the displayed distance by the  $f_{(ERMF)}$  factor to project the measurement on the plane of the attenuator. The  $f_{(ERMF)}$  factor can be computed as  $f_{(ERMF)} = (67.5 - \text{height}) * ERMF / 70.0$ , where "height" is the distance between the top of the breast support platform and the bottom of the attenuator and  $ERMF = 1.073$  by default or 1.0 if changed by Field Service on customer request.
4. Measure the physical width of each attenuator at the direction of the measurement in the Preview screen. Subtract the recorded " $f_{(ERMF)}$  Corrected" number from the physical width of the attenuator maintaining the sign. Record the results as "Attenuator Difference" in the record form.



5. Project the attenuator difference to the image receptor plane by multiplying "Attenuator Difference" by the geometric magnification factor  $f_{(geom)} = 70.0 / (67.5 - \text{height})$  where "height" is the distance between the top of the breast support platform and the bottom of the attenuator. Add the x-ray to light field deviation for each edge as computed in Section 3.2.6.1. Record the results as "Total Deviation" in the record form.
6. Calculate the % of SID deviation maintaining the sign and record the results in the record form.
7. Repeat Step 1 through Step 6 to check the alignment of the left, center and right 18 × 24 cm imaging modes using the second, third and fourth **Flat Field Conv** views, respectively.
8. Repeat Step 1 through Step 6 to check the alignment of the 18 × 29 cm imaging mode using the **Zero-Degree Tomo** view (Tomosynthesis Option). Add the view if necessary.

### Flat Compression Paddle to Image Receptor Alignment

1. Select the **Flat Field Conv** thumbnail image that corresponds to the 24 × 29 cm flat screening compression paddle to display in the Preview screen.
2. Inspect that the chest wall side of the flat compression paddle is not visible in the image. Record the results in the record form.
3. Use the distance-measuring tool to measure the attenuator starting from the edge of the image moving inwards. Record the results as "Preview Measurement" in the record form.
4. Correct the "Preview Measurements" by multiplying the displayed distance by the  $f_{(ERMF)}$  factor to project the measurement on the plane of the attenuator. The  $f_{(ERMF)}$  factor can be computed as  $f_{(ERMF)} = (67.5 - \text{height}) * ERMF / 70.0$ , where "height" is the distance between the top of the breast support platform and the bottom of the attenuator and  $ERMF = 1.073$  by default or 1.0 if changed by Field Service on customer request.
5. Measure the physical width of each attenuator at the direction of the measurement in the Preview screen. Subtract the recorded " $f_{(ERMF)}$  Corrected" number from the physical width of the attenuator maintaining the sign. Record the results as "Attenuator Difference" in the record form.
6. Project the attenuator difference to the image receptor plane by multiplying "Attenuator Difference" by the geometric magnification factor  $f_{(geom)} = 70.0 / (67.5 - \text{height})$  where "height" is the distance between the top of the breast support platform and the bottom of the attenuator. Record the results as "Total Deviation" in the record form.
7. Repeat steps 1 through 6 for the 18 × 24 cm flat and Small Breast (when available) screening compression paddles.



### SmartCurve Compression Paddle to Image Receptor Alignment

1. Select the **Flat Field Conv** thumbnail image that corresponds to the 18 x 24 cm SmartCurve compression paddle to display in the Preview screen.
2. Inspect that the chest wall side of the SmartCurve compression paddle is not visible in the image. Record the results in the record form.
3. Determine the distance between the chest wall edge of the SmartCurve compression paddle and the chest wall edge of the corresponding flat compression paddle. Using the Ruler Measurements, subtract the flat paddle measurement from the corresponding SmartCurve paddle measurement (for example, subtract the 18 x 24 cm flat paddle measurement from the 18 x 24 cm SmartCurve paddle measurement). You should maintain a positive sign "+" if the SmartCurve paddle extends beyond the flat compression paddle and a negative sign "-" if the flat compression paddle extends beyond the SmartCurve paddle. Record the results as "Ruler Measurement Difference" in the record form.
4. Determine the distance that the SmartCurve paddle extends beyond the image receptor. Add the "Ruler Measurement Difference" found in step 3 to the recorded "Attenuator Difference" for the corresponding flat paddle found in step 5 of the previous section. Record the results as "Attenuator Difference + Ruler Measurement Difference" in the record form.
5. Project the "Attenuator Difference + Ruler Measurement Difference" to the image receptor plane by multiplying the "Attenuator Difference + Ruler Measurement Difference" by the geometric magnification factor  $f_{(geom)} = 70.0 / (67.5 - \text{height})$  where "height" is the distance between the top of the breast support platform and the bottom of the attenuator (found in step 6 of the previous section). Record the results as "Total Deviation" in the record form.
6. Repeat steps 1 through 5 for the 24 x 29 cm SmartCurve compression paddle.

### 3.2.7 Recommended Performance Criteria and Corrective Action

#### X-Ray Field to Light-Field Coincidence

The total of any misalignment of the edges of the light field and the x-ray field along either the length or the width of the visually defined field at the plane of the breast support surface must not exceed 2% of the SID.

If the recommended performance criteria are not met, the source of the problem must be identified and corrective action must be taken within thirty days of the test date.

### **X-Ray Field to Image Receptor Alignment**

The x-ray field must not extend by more than 2% of the SID at any of the four sides of the image receptor.

The radiation field must extend beyond the edge of the digital image receptor on the chest wall side of the detector.

If the recommended performance criteria are not met, the source of the problem must be identified and corrective action must be taken within thirty days of the test date.

### **Compression Paddle to Image Receptor Alignment**

The chest wall edge of the compression paddle must be aligned just beyond the chest wall edge of the image receptor so that it does not appear in the mammogram. In addition, the chest wall edge of the compression paddle must not extend beyond the chest wall edge of the image receptor by more than 1% of the SID.

If the recommended performance criteria are not met, the source of the problem must be identified and corrective action must be taken within thirty days of the test date.

### 3.3 Artifact Evaluation

#### 3.3.1 Objective

To assess the degree and source of artifacts visualized in mammograms or phantom images. This procedure allows the source of artifacts to be isolated to x-ray equipment, or DICOM printer.

#### 3.3.2 Frequency

Annually

#### 3.3.3 Suggested Equipment

**D<sub>x</sub>**

- Magnification stand
- Flat Field phantom: 4 cm thick uniform attenuation block of acrylic large enough to cover the digital image receptor. The Flat Field phantom is supplied by the manufacturer.

#### 3.3.4 Test Procedure

##### DICOM Printer Artifact Evaluation

---



**Note**

If the facility does not own or use a printer, the DICOM printer artifact evaluation test is not required.

---



**Note**

As an alternative, you can follow the procedure, requirements and recommendations of the printer manufacturer when performing this test.

---



**Note**

If you have multiple mammography systems printing to a single printer, you only need to perform this test from a single system, since this test is used to access the printer artifact performance and is equivalent regardless of which system is used to perform this test.

---



**Note**

When performing DICOM printer artifact evaluation, an artificial flat field must be sent to the printer following the above procedure. A flat field acquired on the mammography system using the Flat Field phantom is not appropriate for this test and must not be used.

---

1. Select **Admin>Test Patterns**.
2. Select the **Flat Field** pattern as the test pattern.
  - **For 8 x 10 inch (18 x 24 cm) printer film**
    - a. Select the **Image Size: 2560 x 3328**.
    - b. Select the **DICOM printer** device from the Outputs list, and select **8 x 10 inch** or **18 x 24 cm** film.
    - c. Under Options, check **True Size Printing** if available.
    - d. Select the **Send** button to print the flat field pattern on the selected printer.
  - **For 10 x 12 inch (24 x 30 cm) printer film, if supported**
    - a. Select the **Image Size: 3328x4096**.
    - b. Select the **DICOM printer** device from the Outputs list, and select **10 x 12 inch** or **24 x 30 cm** film.
    - c. Under Options, check **True Size Printing** if available.
    - d. Select the **Send** button to print the flat field pattern on the selected printer.
3. Repeat the above steps for all other printers used for printing clinical images.
4. Select the **Back** button to return to the Admin screen.

### System Artifact Evaluation

---



#### Note

Before performing an image quality test, the system must change status from Detector Warming to All Ready.

---



#### Preparation

1. Remove any compression paddle and lower the compression device between 5 cm and 7 cm.
2. Make sure that both the Flat Field phantom and the surface of the image receptor are clean. Place the Flat Field phantom on top of the image receptor to cover its active surface.
3. Select **Admin>Quality Control>Physicist tab>Artifact Evaluation** procedure on the Acquisition Workstation. Select the **Start** button.

**Artifact Evaluation with Rhodium (Rh) and Silver (Ag) Filters Using the Large Focal Spot (LFS)**

1. Select the first **Flat Field Conv** view from the Procedure screen on the Acquisition Workstation.
2. Set the exposure per the following table:

*Table 10: Artifact Evaluation Rh Filter Exposure Techniques*

Mode	kVp	Filter	Focal Spot	AEC Sensor Position
Auto-Time	28	Rh	Large	2

3. Acquire an exposure.
4. Accept the image in the Procedure screen on the Acquisition Workstation.
5. Rotate the Flat Field phantom 180 degrees.
6. Lower the compression device between 5 cm and 7 cm.
7. Select the next **Flat Field Conv** view from the Procedure screen on the Acquisition Workstation.
8. Set the exposure per the following table:

*Table 11: Artifact Evaluation Ag Filter Exposure Techniques*

Mode	kVp	Filter	Focal Spot	AEC Sensor Position
Auto-Time	31	Ag	Large	2

9. Acquire an exposure.
10. Accept the image in the Procedure screen on the Acquisition Workstation.



**Artifact Evaluation (Tomosynthesis Option)**

1. Lower the compression device between 5 cm and 7 cm.
2. Select the next **Flat Field Tomo** view from the Procedure screen on the Acquisition Workstation.
3. Set the exposure per the following table:

*Table 12: Artifact Evaluation Al Filter Exposure Techniques (Tomosynthesis Option)*

Mode	kVp	Filter	Focal Spot	AEC Sensor Position
Auto-Time	30	Al	Large	2

4. Acquire an exposure.
5. Accept the image in the Procedure screen on the Acquisition Workstation.



### Artifact Evaluation (CE2D Option)

1. Lower the compression device between 5 cm and 7 cm.
2. Select the next **Flat Field CEDM** view from the Procedure screen on the Acquisition Workstation.
3. Set the exposure per the following table:

*Table 13: Artifact Evaluation Cu Filter Exposure Techniques (CE2D Option)*

Mode	kVp	mAs	Filter	Focal Spot
Manual	28	100	Rh	Large



#### Note

The CE2D modality is only compatible with Manual and Auto-Filter AEC modes.

---

4. Acquire an exposure.
5. Accept the image in the Procedure screen on the Acquisition Workstation.

**D<sub>x</sub>**

**Artifact Evaluation with Rhodium (Rh) and Silver (Ag) Filters Using the Small Focal Spot (SFS)**

1. Remove the face shield, raise the compression device above the mounting slots in the C-arm and install the magnification stand at the 1.8x mark.
2. Make sure that the Flat Field phantom and both surfaces of the magnification stand are clean. Place the Flat Field phantom on top of the magnification stand to cover its entire surface.
3. Lower the compression device between 5 cm and 7 cm.
4. Select the next **Flat Field Conv** view from the Procedure screen on the Acquisition Workstation.
5. Set the exposure per the following table:

*Table 14: Artifact Evaluation Magnification Exposure Techniques*

Mode	kVp	Filter	Focal Spot	AEC Sensor Position
Auto-Time	28	Rh	Small	2

6. Acquire an image.
7. Accept the image in the Procedure screen on the Acquisition Workstation.
8. Lower the compression device between 5 cm and 7 cm.
9. Rotate the Flat Field phantom 180 degrees.
10. Select the next **Flat Field Conv** view from the Procedure screen on the Acquisition Workstation.
11. Set the exposure per the following table:

*Table 15: Artifact Evaluation Magnification Exposure Techniques*

Mode	kVp	Filter	Focal Spot	AEC Sensor Position
Auto-Time	31	Ag	Small	2

12. Acquire an image.
13. Accept the image in the Procedure screen on the Acquisition Workstation.

**Complete the Procedure**

1. Move to the "Data Analysis and Interpretation" section.
2. Select the **End QC** button to mark the Quality Control procedure as completed when you are done with Data Analysis and Interpretation.

**3.3.5 Record Forms**

Use the "Artifact Evaluation" form in Appendix A to record the results.

### 3.3.6 Data Analysis and Interpretation

#### DICOM Printer Artifact Evaluation

1. Review the printed film of the artificial flat field sent to the printer from a single system following the instructions above or from the printer's Quality Control menu.
2. Any artifacts that appear on the printed film are created by the printer alone since the artificial test pattern used contains pixels of a single value across the entire pattern.

#### System Artifact Evaluation

1. Select the first **Flat Field Conv** thumbnail image in the Procedure screen on the Acquisition Workstation to display on the Preview screen.
2. Select the **Actual Pixels** button  to bring the image into full resolution. Examine the entire image for artifacts; use the magnification tool if necessary.

---

#### Note



Acquiring an image for artifact evaluation using the Flat Field view sets the image window to 500 and the image level to the exposure index automatically. Artifact evaluation must be performed under these predefined settings.

---

3. Repeat Step 2 for the remaining **Flat Field Conv** thumbnail images.
4. Repeat Step 2 for the **Flat Field Tomo** thumbnail image (Tomosynthesis Option). You only need to examine the middle projection at around 0 degrees.
5. If the dual-energy subtracted image is displayed after acquisition, select the **Contrast** tab. Select the  button (typically used to show the low-energy image for patient CEDM views) to display the Cu filter exposure. Repeat Step 2 for the **Flat Field CEDM** thumbnail image (CE2D Option).

If the location of artifacts between the two LFS or SFS images changes corresponding with the rotation of the Flat Field phantom, the artifacts are present in the acrylic block and do not indicate problems in system performance. Record the results in the record form.

Appearance of artifacts in one of the two LFS or SFS images may indicate filtration artifacts. The medical physicist must evaluate these images using the same methods for evaluating screen-film artifact images.

Artifacts that appear in identical locations on the SFS Flat Field Conv thumbnail images, and are different from those identified in the LFS Flat Field Conv thumbnail images, indicate a potential artifact on the magnification stand.

Artifacts that appear in identical locations on both LFS and SFS images indicate a potential problem in the imaging chain. To isolate these types of artifacts between the x-ray source and the digital image receptor:





- a. Place a loaded mammographic cassette (or equivalent recording medium) on top of the digital image receptor; place the Flat Field phantom on top of the cassette.
- b. Open the previously created examination for the purpose of artifact evaluation.
- c. Select the **Add View** button in the Procedure screen and add another **Flat Field Conv** view.
- d. Select the new **Flat Field Conv** view and make a manual exposure per the following table:

Table 16: Artifact Evaluation Exposure Techniques

Mode	kVp	mAs	Filter	Focal Spot
Manual	28	60	Rh	Large

- e. Accept the image in the Procedure screen and process the film.
- f. Evaluate the screen-film image with regards to the artifacts observed in Step 2. Artifacts that appear on the original digital images but do not appear on the screen-film image may be attributed to the digital image receptor. A qualified service engineer must eliminate any artifacts that may be clinically objectionable.
- g. Artifacts that appear on both the digital and screen-film images are not caused by the digital image receptor. The medical physicist must evaluate these images using the same methods for evaluating screen-film artifact images.

### 3.3.7 Recommended Performance Criteria and Corrective Action

The recommendations and corrective actions specified in the *1999 ACR Mammography Quality Control Manual*, "Artifact Evaluation" section must be followed for DICOM printer artifacts. A qualified service engineer must correct the source of intolerable artifacts on the DICOM printer within thirty days of the test date.

Artifacts that are traced to the digital image receptor or the x-ray unit must be eliminated by a qualified service engineer within thirty days of the test date. If artifacts cannot be eliminated, the medical physicist must consult with the radiologist for assistance in evaluating whether any remaining artifacts may interfere with image interpretation or may be tolerable.



**Note**

Artifacts that appear on the digital image receptor and are not dropped pixels or lines may be able to be removed by recalibrating the digital detector according to the Quality Control Activities for the Radiologic Technologist, Detector Flat Field Calibration section of this manual.



**Note**

Artifacts that appear on the Flat Field phantom provided by the manufacturer must not be overlooked. Such artifacts will have an impact on detector calibration since the same block is being used during detector calibration. Replacement of the Flat Field phantom must be considered.

### 3.4 kVp Accuracy and Reproducibility

#### 3.4.1 Objective

To assure that the selected kVp is accurate within limits and reproducible between exposures.

#### 3.4.2 Frequency

Annually

#### 3.4.3 Suggested Equipment

- Calibrated, non-invasive mammographic kVp meter capable of measuring kVp to an accuracy of 1.5 kVp and a precision of 0.5 kVp within the mammographic energy range and calibrated to the correct target/filter combinations used; or invasive kVp divider or similar equipment (see note).
- 0.5 mm or thicker lead or lead equivalent block, wide enough to cover the entire surface of the digital image receptor

#### 3.4.4 Test Procedure



---

**Caution:**

**The image receptor can be damaged by excessive radiation exposure. Be sure to cover the receptor with a layer of 0.5 mm or thicker lead or lead equivalent (i.e., lead apron) prior to carrying out this procedure.**

---



---

**Note**

If a non-invasive kVp meter is used to measure kVp, it must be calibrated to the target-filter combination and kVp range used. Otherwise, an invasive measurement of kVp is recommended. The test may be performed by Hologic Service personnel equipped with the appropriate tools and reviewed by the medical physicist. If you need assistance, please contact Hologic Service. Hologic Service carries calibrated non-invasive kVp meters and has access to invasive devices as a last resort.

---

1. Select **Admin>Quality Control>Physicist tab>kVp Accuracy and Reproducibility** procedure on the Acquisition Workstation. Select the **Start** button.
2. **Important:** Cover the digital image receptor with at least 0.5 mm lead or lead equivalent.
3. Set up the kVp meter or invasive kVp divider following the manufacturer's instructions.
4. Select the conventional mode exposure setting. Under the "Conv" tab, manually set the system to a clinically used kVp and mAs. Record the focal spot size and mAs used.
5. Make four exposures at the manually set techniques and record the measured kVp values for each exposure.

6. Take measurements for two other clinically relevant kVp settings, making only a single exposure for each. (Assessment of reproducibility is only required for a single kVp setting except for troubleshooting purposes.) The other two selected kVp settings should include the lowest and highest clinically relevant settings that can be reliably measured by the kVp measuring device.



**Note**

Use the **Zero-Degree Tomo** modality to measure the kVp under tomosynthesis. Using this modality, the system will acquire all tomosynthesis projections at 0 degrees; thus, you will avoid any issues due to tube angulation. When performing the measurement under tomosynthesis, the compression thickness registered on the compression device should be lower than 24 cm for the exposure to be allowed (Tomosynthesis Option).

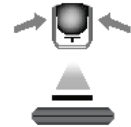

7. Select a clinically used kVp and set a manual value for the mAs. Record the kVp, focal spot size, and mAs used.
8. Take a single acquisition and record the measured kVp.
9. Select the **Back** button. Select the **Yes** button to mark the Quality Control procedure as completed.

### 3.4.5 Record Forms

Use the "kVp Accuracy and Reproducibility" form in Appendix A to record the results.

### 3.4.6 Data Analysis and Interpretation

Calculate the average and the standard deviation of the four kVp measurements made in the conventional mode. Determine kVp accuracy by comparing the average kVp to the selected kVp setting. All average measured kVps must be within  $\pm 5\%$  of the selected kVp settings.

Calculate the coefficient of variation by dividing the standard deviation of the kVp measurements by the average of the kVp measurements. The coefficient of variation must not exceed 0.02 for any kVp setting.

### 3.4.7 Recommended Performance Criteria and Corrective Action

The kVp must be accurate within  $\pm 5\%$  of the indicated or selected kVp at:

- the lowest clinical kVp that can be measured by a kVp test device
- 28 kVp
- the highest available clinical kVp

At 28 kVp, the coefficient of variation of the kVp must be equal to or less than 0.02.

If the recommended performance criteria are not met, the source of the problem must be identified and corrective action must be taken within thirty days of the test date.

## 3.5 Beam Quality Assessment—Half-Value Layer Measurement

### 3.5.1 Objective

To assure that the half-value layer (HVL) of the x-ray beam is adequate to minimize patient dose.

### 3.5.2 Frequency

Annually

### 3.5.3 Suggested Equipment

- Calibrated mammographic ionization meter and electrometer
- Five to seven aluminum 1145 or 1100 alloy sheets of 0.1 mm thickness, large enough to cover the full area of the dosimeter and with thickness accurate to within  $\pm 1\%$  of the nominal value
- 0.5 mm or thicker lead or lead equivalent block, wide enough to cover the entire surface of the digital image receptor
- 18 x 24 cm flat compression paddle

### 3.5.4 Test Procedure



**Caution:**

The image receptor can be damaged by excessive radiation exposure. Be sure to cover the receptor with a layer of 0.5 mm or thicker lead or lead equivalent (i.e., lead apron) prior to carrying out this procedure.

---

1. Select **Admin>Quality Control>Physicist tab>Beam Quality—Half-Value Layer Measurement** procedure on the Acquisition Workstation.
2. Select the **Start** button.
3. **Important:** Cover the digital image receptor with at least 0.5 mm lead or lead equivalent.
4. Set up the exposure meter following the manufacturer's instructions. Place the meter 4.5 cm above the breast platform, 4 cm away from the chest wall edge of the detector, and centered in the left-right direction.



**Note**

To reduce the effects of backscatter, the x-ray field can be collimated to smaller sizes by pushing the collimation override button on the gantry until the desired collimation size is reached. Use the light field to verify that the meter is fully exposed.

---

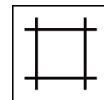

5. Raise the compression paddle to a display height of at least 20 cm.
6. Set manual techniques at the most common clinical kV setting with the Rh filter. Record the kV and mAs settings.

**Ionization Meter with Electrometer Option**

1. Acquire a manual exposure without any aluminum sheets and record the meter reading (E0a).
2. Place enough Al sheets on top of the compression paddle to obtain an exposure measurement that is just above half of the original exposure reading taken in step 1 (for example, 0.4 mm of Al). Record the meter reading (Ea) and thickness of the added Al filters (ta).



**Note**

Use the light field to confirm full coverage of the meter by the Al filters.

3. Repeat step 2, placing additional Al filters on top of the compression paddle. Adjust the thickness of filters and acquire exposures until the meter reading is reduced to just below half of the reading from step 1. Record the meter reading (Eb) and thickness of the added Al filters (tb).
4. Remove all Al filters from the compression paddle and take an exposure. Record the meter reading (E0b). If this reading differs by more than 2% from the measurement made in step 1 (E0a), repeat all measurements.
5. Repeat the HVL measurements for the other applicable target/filter combinations provided in the record form. Record the kVp and mAs settings used.

**Solid-State Meter Option**

1. Acquire a manual exposure without any aluminum sheets and record the HVL measurement from the meter.
2. Repeat the HVL measurements for the other applicable target/filter combinations provided in the record form, ensuring that the meter is calibrated to the correct target/filter setting. Record the kVp and mAs settings used.



**Note**

Use the **Zero-Degree Tomo** modality to measure the HVL under tomosynthesis. Using this modality, the system will acquire all tomosynthesis projections at 0 degrees; thus, you will avoid any field coverage or effective foil thickness issues due to tube angulation. When performing the measurement under tomosynthesis, the compression thickness registered on the compression device should be lower than 24 cm for the exposure to be allowed (Tomosynthesis Option).

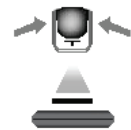

**Note**

Use the Conventional modality and select the Cu filter to measure the HVL for the CE2D high energy exposure. Adjust the kVp accordingly (i.e. 45 kVp) when using the Cu filter (CE2D Option). Use two to four aluminum 1145 or 1100 alloy sheets of 1 mm thickness for HVL measurements.

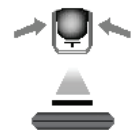

3. Select the **Back** button. Select the **Yes** button to mark the Quality Control procedure as completed.

### **3.5.5 Record Forms**

Use the "Beam Quality Assessment—HVL Measurement" form in Appendix A to record the results.

### **3.5.6 Data Analysis and Interpretation**

If an ionization meter is used, refer to the "Beam Quality Assessment—HVL Measurement" form in Appendix A to calculate the HVL through logarithmic interpolation.

### **3.5.7 Recommended Performance Criteria and Corrective Action**

The system must perform according to the following criterion:

- For operating kVp range of less than 50, the measured HVL must be greater than  $(\text{kVp}/100) + 0.03$  (in mm Al).

If the recommended performance criteria are not met, the source of the problem must be identified and corrective action must be taken within thirty days of the test date.

### 3.6 Evaluation of System Resolution

#### 3.6.1 Objective

To evaluate imaging performance, using the system limiting spatial resolution as a performance indicator that may be easily measured in the field.

#### 3.6.2 Frequency

Annually

#### 3.6.3 Suggested Equipment

- 18 x 24 cm flat compression paddle
- High contrast resolution pattern providing a test up to 15 cycle/mm (c/mm, or lp/mm) with 1 c/mm steps in the range 3 – 15 c/mm
- Flat Field phantom

#### 3.6.4 Test Procedure



**Note**

Before performing an image quality test, the system must change status from Detector Warming to All Ready.



1. Select **Admin>Quality Control>Physicist tab>Evaluation of System Resolution** procedure on the Acquisition Workstation.
2. Select the **Start** button.
3. Place the Flat Field phantom on top of the image receptor and center it laterally to cover its entire surface.
4. Place the resolution test pattern on top of the Flat Field phantom. Position the pattern within 1 cm of the chest wall edge of the image receptor, centered laterally. The test pattern lines must be at 45° to the anode-cathode axis.
5. Install the 18 x 24 cm flat compression paddle in the compression device.
6. Lower the compression paddle to touch the resolution pattern and apply between 15 and 20 pounds of force.
7. Select the **Flat Field Conv** view from the Procedure screen on the Acquisition Workstation and acquire an exposure per the following table:

*Table 17: System Resolution Exposure Techniques*

Mode	kVp	mAs	Filter	Focal Spot
Manual	28	120	Rh	Large



8. Accept the image in the Procedure screen on the Acquisition Workstation.
9. Select the **Flat Field Tomo** view from the Procedure screen on the Acquisition Workstation and acquire an exposure per the following table (Tomosynthesis Option):

*Table 18: System Resolution Exposure Techniques (Tomosynthesis Option)*

Mode	kVp	mAs	Filter	Focal Spot
Manual	30	50	Al	Large

Accept the image in the Procedure screen at the Acquisition Workstation.

10. Move to the "Data Analysis and Interpretation" section.
11. Select the **End QC** button to mark the Quality Control procedure as completed when you are done with Data Analysis and Interpretation.

### 3.6.5 Record Forms

Use the "System Limiting Spatial Resolution" form in Appendix A to record the results.

### 3.6.6 Data Analysis and Interpretation



1. Select the **Flat Field Conv** (Tomosynthesis Option: **Flat Field Tomo**) thumbnail image in the Procedure screen to display in the Preview screen.
2. Select the **Actual Pixels** button  to display the resolution pattern in full resolution.

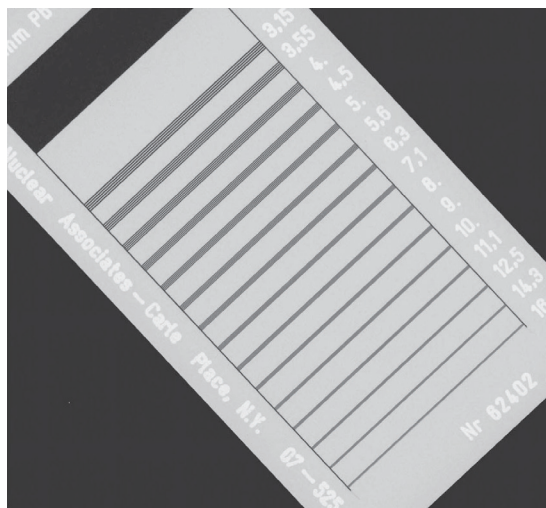

*Figure 3: The Resolution Test Pattern in the Preview Pane*

3. Move the pattern to the center of the preview display.
4. Determine the highest frequency lines that are distinctly resolved (and ensure the correct number of lines is visualized) across some part of the resolution pattern.





**Note**

Use the Magnification tool and Window/level tool to show the details of the resolution pattern image better. There are likely to be regions where the pattern fades from being resolved, due to imperfect alignment of the bar pattern with the image matrix. Once a blur is seen across the entire length of the lines, a phase shift (bright lines shift to dark, and vice versa), or aliasing (fewer bars are visualized), record this frequency as the limiting spatial resolution.

---



5. Record the limiting spatial resolution in the corresponding form.
6. Switch to the tomosynthesis reconstruction preview and scroll up to the reconstruction plane where the bar phantom is seen in focus (image windowing may be necessary to see the bar pattern clearly) (Tomosynthesis Option).
7. Repeat Step 2 to Step 5 and record the limiting resolution seen under tomosynthesis (Tomosynthesis Option).

### 3.6.7 Recommended Performance Criteria and Corrective Action

The system limiting spatial resolution under conventional imaging must be greater than 7 c/mm (lp/mm) when the bars are at 45° to the anode-cathode axis.



The system limiting spatial resolution under tomosynthesis imaging must be greater than 3 c/mm (lp/mm) when the bars are at 45° to the anode-cathode axis (Tomosynthesis Option).

If these criteria are not met, a qualified service engineer must correct the problem before using the system for clinical imaging.

### 3.7 Automatic Exposure Control (AEC) Function Performance

#### 3.7.1 Objective

To assess the performance of the automatic exposure control (AEC) function and to maintain consistency in detector signal level for a range of breast thicknesses and all applicable imaging modes. To evaluate the Exposure Compensation function of the AEC.

#### 3.7.2 Frequency

Annually

#### 3.7.3 Suggested Equipment

- 18 x 24 cm flat compression paddle
- 10 x 10 cm magnification paddle
- Magnification stand
- Acrylic or BR-12 blocks to provide a phantom of 2, 4, 6 and 8 cm thickness

**D<sub>x</sub>**

#### 3.7.4 Test Procedure



---

**Note**

Before performing an image quality test, the system must change status from Detector Warming to All Ready.

---



#### AEC Function Performance at Different Phantom Thickness

1. Select **Admin>Quality Control>Physicist tab>Automatic Exposure Control (AEC) Function Performance** procedure on the Acquisition Workstation.
2. Select the **Start** button.
3. Install the 18 × 24 cm flat compression paddle in the compression device.
4. Center the first 2.0 cm of acrylic or BR-12 phantom laterally on the image receptor and position it so that the chest wall edge of the phantom is aligned with the chest wall edge of the image receptor.
5. Lower the compression device and apply compression force to achieve a compression thickness equal to the thickness of the phantom used.

- Set the exposure techniques per the following table:

Table 19: AEC Function Performance Exposure Techniques

Mode	kVp	Filter	Focal spot	Exposure Compensation	AEC Sensor
AEC mode used clinically (i.e., Auto-Filter)	Clinically used values, if applicable in the selected AEC mode	Clinically used values, if applicable in the selected AEC mode	Large	0, or the step used clinically	2

- Select a **Flat Field Conv** view from the Procedure screen and acquire an exposure.

- Record, in the record form, the Exposure Index indicated at the bottom of the dose dial.

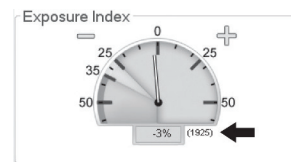

- Record the kVp, mAs, filter and exposure compensation step if it is required by the record form.

- Accept the image in the Procedure screen at the Acquisition Workstation.

- Select a **Flat Field Tomo** view from the Procedure screen and acquire and exposure (Tomosynthesis Option).

- Switch to the tomosynthesis reconstruction preview and repeat Step 8 through Step 10 for the tomosynthesis part of the acquisition (Tomosynthesis Option).

- Repeat Step 4 through Step 12 for phantom thicknesses of 4, 6 and 8 cm.

### AEC Function Performance at Different Exposure Compensation Steps

- Center the 4.0 cm of acrylic or BR-12 phantom laterally on the image receptor and position it so that the chest wall edge of the phantom is aligned with the chest wall edge of the image receptor.
- Lower the compression device and apply compression force to achieve a compression thickness equal to the thickness of the phantom used.
- Set the exposure techniques per the following table:

Table 20: AEC Function Performance Exposure Techniques

Mode	kVp	Filter	Focal spot	Exposure Compensation	AEC Sensor
AEC mode used clinically (i.e., Auto-Filter)	Clinically used values, if applicable in the selected AEC mode	Clinically used values, if applicable in the selected AEC mode	Large	All	2



4. Select a **Flat Field Conv** view from the Procedure screen and acquire an exposure.
5. Record, in the record form, the Exposure Index indicated at the bottom of the dose dial.
6. Record the kVp, mAs, filter and exposure compensation step if it is required by the record form.
7. Accept the image in the Procedure screen at the Acquisition Workstation.
8. Repeat Step 4 to Step 7 for the remaining exposure compensation steps. Make sure that three exposures are acquired at the 0 exposure compensation step.

**AEC Function Performance at Different Operating Modes**

**D<sub>x</sub>**

1. Replace the 18 x 24 cm paddle with the 10 x 10 cm magnification paddle.
2. Install the magnification stand (automatically retracts the grid and sets the system to SFS).
3. Center 4.0 cm of acrylic or BR-12 phantom laterally on the magnification stand and position it so that the chest wall edge of the phantom is aligned with the chest wall edge of the magnification stand.
4. Lower the compression device and apply compression force, if necessary, to achieve a compression thickness equal to the thickness of the phantom used.
5. Set the exposure techniques per the following table:

*Table 21: AEC Function Performance Exposure Techniques*

Mode	kVp	Filter	Focal spot	Exposure Compensation	AEC Sensor
AEC mode used clinically (i.e., Auto-Filter)	Clinically used values, if applicable in the selected AEC mode	Clinically used values, if applicable in the selected AEC mode	Small	0, or the step used clinically	2

6. Select a **Flat Field Conv** view from the Procedure screen and acquire an exposure.
7. Record, in the record form, the Exposure Index indicated at the bottom of the dose dial.
8. Record the kVp, mAs, filter and exposure compensation step if it is required by the record form.
9. Accept the image in the Procedure screen at the Acquisition Workstation.
10. Move to the "Data Analysis and Interpretation" section.
11. Select the **End QC** button to mark the Quality Control procedure as completed when you are done with Data Analysis and Interpretation.

### 3.7.5 Record Forms

Use the "Automatic Exposure Control (AEC) Function Performance" form in Appendix A to record the results.

### 3.7.6 Data Analysis and Interpretation

1. Using the recorded corrected pixel values calculate a corrected mean pixel value for all breast thicknesses and all operating modes.
2. Determine the range of corrected pixel values recorded for all breast thicknesses and all operating modes.
3. Compute the fractional change in pixel value with respect to the mean pixel value computed for the 0 exposure compensation step (average of three exposures). This computation can be expressed as the pixel value at a given step divided by the mean pixel value at step 0.

### 3.7.7 Recommended Performance Criteria and Corrective Action

The AEC function of the system is trying to maintain a constant pixel value (detector signal level) independent of AEC mode, operating mode (contact vs. magnification), breast thickness, or selected radiographic technique. As the AEC is trying to maintain constant pixel value for the entire range of breast thickness, the image CNR is decreased slightly at large breast thickness. To compensate for the drop of CNR at large breast thickness, the system corrects the AEC computed mAs by a small factor. This correction is a simple multiplication factor applied to the AEC-determined mAs.

As the AEC function targets a constant pixel value independent of breast thickness or operating mode, the pixel value of each acquired image for corresponding breast thickness between 2 and 8 cm at any operating mode must not vary more than 10% of the mean pixel value recorded from all tested breast thicknesses and operating modes. If a compensation factor was applied to the AEC function by Selenia Dimensions system to boost CNR at large breast thickness, the pixel value must be corrected to the AEC-computed value to evaluate this test. To correct the pixel value to the one computed by AEC, simply divide the measured pixel value by the CNR correction factor. The CNR correction factors are listed in Appendix D of this manual. The correction factors must correspond to the compression thickness indicated on the compression device, and not to the physical thickness of the phantom used.

The exposure compensation steps must result in the following changes in pixel value when dividing the pixel value at a given step by the mean pixel value at step 0:

Step -3: 0.56 – 0.66

Step -2: 0.66 – 0.78

Step -1: 0.78 – 0.92

Step +1: 1.06 – 1.24

Step +2: 1.22 – 1.43

Step +3: 1.40 – 1.64

Step +4: 1.61 – 1.89

# Quality Control Manual for Selenia Dimensions and 3Dimensions Systems

## Chapter 3: Quality Control Activities for the Medical Physicist

---

Each exposure compensation step is designed to result in an additional 15% change in dose to the ACR phantom. The accuracy of the total change in dose is expected to be within 8% of the targeted dose.

If the above criteria are not met, the source of the problem must be identified and corrective action must be taken within thirty days of the test date.



---

### Note

The tomosynthesis imaging mode does not have exposure compensation steps (Tomosynthesis Option). The allowed range of corrected pixel values for tomosynthesis is calculated separately from the range for the contact and magnification operating modes.

---

### 3.8 Breast Entrance Exposure, AEC Reproducibility, and AGD

#### 3.8.1 Objective

To measure the typical entrance exposure and calculate the corresponding glandular dose for an average patient with approximately 4.2 cm compressed breast thickness of 50% adipose, 50% glandular tissue composition; to assess the reproducibility of the automatic exposure control (AEC).

#### 3.8.2 Frequency

Annually

#### 3.8.3 Suggested Equipment

- 24 x 29 cm flat compression paddle
- Calibrated mammographic ionization meter and electrometer or an integrated, solid state meter capable of making accurate measurements within the mammographic energy range.
- ACR Mammographic Accreditation Phantom (i.e., RMI 156 by Radiation Measurement, Inc.; 18-220 by Nuclear Associates)

#### 3.8.4 Test Procedure



---

##### Note

Before performing an image quality test, the system must change status from Detector Warming to All Ready.

---



##### Preparation

1. Select **Admin>Quality Control>Physicist tab>Dose and AEC Reproducibility** procedure on the Acquisition Workstation.
2. Select the **Start** button.
3. Install the 24 x 29 cm flat compression paddle in the compression device.

- Center the ACR phantom laterally on the image receptor and position it so the chest wall edge of the phantom is aligned with the chest wall edge of the image receptor.

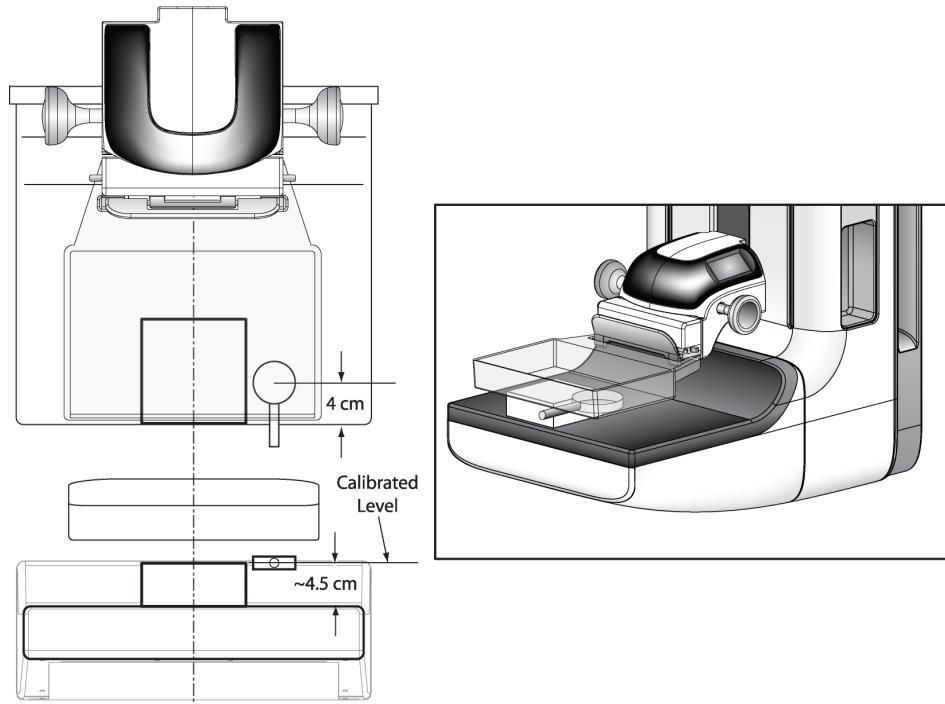

Figure 4: ACR Phantom and Ionization Chamber Setup

- Position the ionization chamber in the x-ray field beside the ACR phantom, centered 4.0 cm in from the chest-wall edge of the image receptor and with the center of the chamber level with the top surface of the ACR phantom as shown in the previous figure. Assure that the entire chamber is exposed.
- Secure the chamber in position and do not change the position of the chamber during the following measurements.

**Acquiring Images Under the Conventional Modality**

- Select an **ACR Phantom Conv** view from the Procedure screen. When using this view, the system assumes that an ACR phantom is being imaged and will assume a thickness of 4.2 cm when determining the exposure techniques.
- Set the Exposure Techniques:

Table 22: Breast Entrance Exposure, AEC Reproducibility, and AGD Exposure Techniques

Mode	kVp	Filter	Focal spot	Exposure Compensation	AEC Sensor
AEC mode that is used clinically (i.e., Auto-Filter)	Clinically used values, if applicable in the selected AEC mode	Clinically used values, if applicable in the selected AEC mode	Large	0, or step used clinically	2



3. Acquire four exposures in the selected AEC mode and record the measurements in the record form (Form 8a).



**Acquiring Images Under the Tomosynthesis Option**

1. Set the exposure techniques according to the previous table.
2. Select an **ACR Phantom Tomo** view from the procedure screen.
3. Acquire four exposures in the selected AEC mode and record the measurements in the record form (Form 8b).
4. Select an **ACR Phantom Combo** view from the procedure screen.
5. Acquire a single exposure in the selected AEC mode and record the measurements in the record form (Form 8c). Record the measurement for the tomosynthesis portion of the DM + BT acquisition separately from the conventional portion of the DM + BT acquisition.



**Warning:**

**Enhanced acquisition mode with combo mode imaging (DM + BT) can produce radiation dose that is higher than the MQSA screening limit of 3.0 mGy and therefore should only be used in diagnostic evaluation.**



**Note**

The doses for DM and tomosynthesis are measured both in individual tests, and also together as part of the DM + BT procedure. It is not uncommon nor a defect for the doses to vary in the two modes, i.e. the tomosynthesis dose measured individually and as part of the DM + BT procedure can differ. The DM and tomosynthesis dose in the DM + BT mode are calibrated separately from the DM and tomosynthesis dose calibrations used in the individual exposure modes, and so will not be identical. Additionally, a site might have specifically requested that the doses be set differently in DM + BT compared to individual DM exposures such as might be desired for screening and diagnostic applications. The important point is that the doses in each mode (DM, tomosynthesis, DM + BT), each meet the specified pass/fail criteria.



**Note**

If the exposure meter does not capture the tomosynthesis and conventional portions of the exposure separately, record the exposure value of the tomosynthesis series while the DM + BT acquisition is taking place. Then, subtract that value from the overall recorded exposure value to determine the exposure corresponding to the conventional image.



### Acquiring Images Under the CE2D Option

1. Set the exposure techniques according to the previous table.
2. Select an **ACR Phantom CEDM** view from the procedure screen.
3. Acquire four exposures in the selected AEC mode and record the measurements in the record form (Form 8d).



#### Note

An ACR Phantom CEDM view includes both a low and a high energy exposure. If the measuring equipment does not allow for separating the low from the high exposure, then you can use the average R/mAs computed from form 8a and the mAs of the low energy exposure to distribute the accumulated exposure between the low and the high energy exposures.

---

### Complete the Procedure

1. Move to the "Data Analysis and Interpretation" section.
2. Select the **End QC** button to mark the Quality Control procedure as completed when you are done with Data Analysis and Interpretation.

### 3.8.5 Record Forms

Use the "Breast Entrance Exposure, AEC Reproducibility, and Average Glandular Dose" forms in Appendix A to record the results.

### 3.8.6 Data Analysis and Interpretation

1. Record the HVL (previously measured in beam quality assessment test) on the record form assuring that it matches the kVp used to take the exposures.
2. Compute the mean exposure and mAs values and corresponding standard deviations for the four acquired exposures. Record the results in the record form.
3. If necessary, correct the average exposure with the chamber's appropriate energy correction factor and with an inverse-square correction factor to obtain the exposure at skin entrance level.
4. Use the appropriate glandular dose table in Appendix C to determine the exposure to glandular dose conversion factor for the kVp, target-filter combination used and measured HVL.
5. Multiply the conversion factor obtained in step 4 by the average entrance exposure value computed in steps 2 and 3 paying attention to units. The product represents the mean glandular tissue dose for that specific energy, breast composition, and compressed thickness and is an approximation of the actual glandular dose.



**Note**

The average glandular dose computed for this test only applies to a 4.2 cm compressed breast of 50-50 tissue composition. Conversion factors for other breast thicknesses and compositions may be found in the literature: Dance DR. "Monte Carlo calculation of conversion factors for the estimation of mean glandular dose." *Phys Med Biol* 35: 1211-1219 (1990); Wu X, Gingold EL, Barnes GT and Tucker DM. "Normalized average glandular dose in molybdenum target – rhodium filter and rhodium target – rhodium filter mammography." *Radiology* 193: 83-89 (1994); Sobol WT and Wu X. "Parametrization of mammography normalized average glandular dose tables." *Med Phys* 24: 547:554 (1997).

The following references are also relevant to dose computations in mammography: John Boone, "Normalized glandular dose (DgN) coefficients for arbitrary x-ray spectra in mammography: computer-fit values of Monte Carlo data", *Medical Physics*, 29(5): 869-875 (2002); John Boone et al, "Molybdenum, Rhodium, and Tungsten anode spectral models using interpolating polynomials with application to mammography", *Medical Physics*, 24(12):1863-1874 (1997); John Boone, "Glandular breast dose for monoenergetic and high-energy x-ray beams: Monte Carlo assessment", *Radiology*, 213:23-37 (1999).

---



**Note**

In conventional mammography, the mean glandular dose is calculated through the product of the x-ray skin entrance exposure and the dose conversion factor. The skin entrance exposure is obtained with direct measurement with an x-ray exposure meter and the dose conversion factor is obtained from simulation study in literatures. In this system, the calculation of patient mean glandular dose of a tomosynthesis procedure is approximated with the same measurement and calculation method of mammography. The skin entrance exposure is the value measured with the x-ray tube performing a sweep over a 15 degree scan angle. The dose conversion factor is directly from a mammography look-up table for dose calculation assuming a stationary x-ray tube. Potential errors are from dose conversion factor difference between a mammography procedure (stationary x-ray tube) and tomosynthesis procedure (moving x-ray tube).

The differences in dose conversion factor between mammography and tomosynthesis procedures are reported in two papers<sup>2,3</sup>. For each projection angle  $\alpha$ , the ratio of the glandular dose for that projection to the glandular dose for the zero degree projection was computed. This ratio was denoted the relative glandular dose coefficient  $RGD(\alpha)$ . The relative dose difference is obtained by averaging the  $RGD(\alpha)$  value over +/- 7.5 degree angle range in Figures 1-2 of Ref. 2. It is estimated that the dose conversion factor error is less than 1% for a scan angle of +/- 7.5 degree.

---

[2]. Ioannis Sechopoulos, Sankararaman Suryanarayanan, Srinivasan Vedantham, and Carl D'Orsi, Andrew Karellas, "Computation of the glandular radiation dose in digital tomosynthesis of the breast", *Med. Phys.* 34, 221-232, 2007

[3]. Ioannis Sechopoulos, a and Carl J. D'Orsi, "Glandular radiation dose in tomosynthesis of the breast using tungsten targets", *Journal of Applied Clinical Medical Physics*, Vol. 9, No. 4, 161-171, 2008.

### 3.8.7 Recommended Performance Criteria and Corrective Action

The coefficient of variation for both exposure and mAs must not exceed 0.05.

The mean glandular dose to the ACR Mammographic Accreditation phantom must not exceed 3 mGy (300 mrad) per view at the recommended techniques for imaging an average breast.



The total mean glandular dose to the ACR Mammographic Accreditation phantom must not exceed 3 mGy (300 mrad) per view when combining the conventional and the tomosynthesis exposures at the recommended techniques for imaging an average breast (Tomosynthesis Option).



The total mean glandular dose to the ACR Mammographic Accreditation phantom must not exceed 3 mGy (300 mrad) per view when combining low and the high energy exposures at the recommended techniques for imaging an average breast (CE2D Option).

If the reproducibility criteria are not met, the source of the problem must be identified and corrective action must be taken within thirty days of the test date.

If the average glandular dose criteria are not met, a qualified service engineer must correct the problem before using the system for clinical imaging.

## 3.9 Radiation Output Rate

### 3.9.1 Objective

To measure the radiation output rate of the system.

### 3.9.2 Frequency

Annually

### 3.9.3 Suggested Equipment

- 24 x 29 cm flat compression paddle
- Calibrated mammographic ionization meter and electrometer or an integrated, solid state meter capable of making accurate measurements within the mammographic energy range
- 0.5 mm or thicker lead or lead equivalent block, wide enough to cover the entire surface of the digital image receptor

### 3.9.4 Test Procedure



---

**Caution:**

The image receptor can be damaged by excessive radiation exposure. Be sure to cover the receptor with a layer of 0.5 mm or thicker lead or lead equivalent (i.e., lead apron) prior to carrying out this procedure.

---

1. Select **Admin>Quality Control>Physicist tab>Radiation Output Rate** procedure on the Acquisition Workstation.
2. Select the **Start** button.
3. Install the 24 x 29 cm flat compression paddle in the compression device.
4. **IMPORTANT:** Cover the digital image receptor with at least 0.5 mm lead or lead equivalent.
5. Position the ionization chamber in the x-ray field centered laterally on the image receptor, 4.0 cm in from the chest-wall edge and with the center of the chamber level at 4.5 cm above the breast support plate as shown in the following figure. Assure that the entire chamber is exposed.

6. Lower the compression device so that the compression paddle is just in contact with or slightly above the ionization chamber.

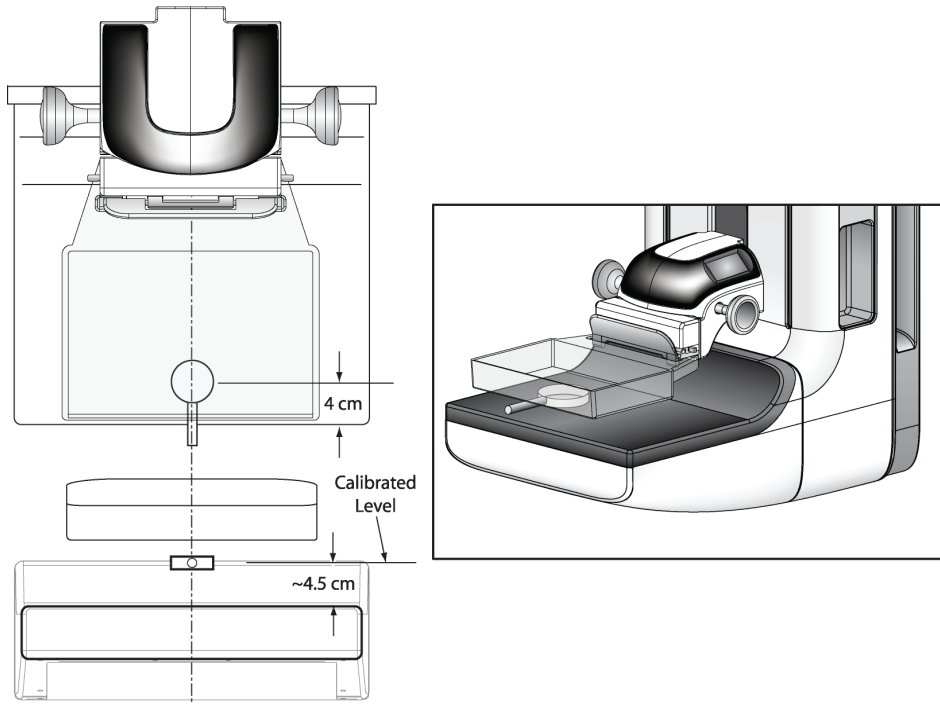

Figure 5: Centered Ionization Chamber

7. Select these exposure techniques:

Table 23: Radiation Output Rate Exposure Techniques

Mode	kVp	mAs	Filter	Focal spot
Manual	28	maximum	Rh	large

8. Acquire an exposure and record the measured radiation exposure and measured exposure time on the record form. (If the electrometer does not measure exposure time, the x-ray unit's indicated mAs may be used or a separate time-measuring device must be used.)
9. Select the **Back** button. Select the **Yes** button to mark the Quality Control procedure as completed.

### 3.9.5 Record Forms

Use the "Radiation Output Rate" form in Appendix A to record the results.

### 3.9.6 Data Analysis and Interpretation

1. Calculate the exposure rate by dividing the measured exposure by the measured (or indicated) exposure time.
2. To compute the air kerma rate, multiply the measured exposure rate by 0.00873 mGy/mR.



---

**Note**

The nominal mA setting for the large focal spot at 28 kVp is 160 mA. For the mA setting at different kVps, please review the system specifications in "Appendix A—Specifications" of the User or Service Manual.

---

### 3.9.7 Recommended Performance Criteria and Corrective Action

The system must be capable of producing a minimum output of:

*Table 24: Radiation Output Rate Requirements*

X-Ray Tube	kVp	Tube Output in mGy/s	Tube Output in mR/s
W	28	2.0	230

when measured by an ionization chamber with its center located 4.5 cm above the breast support surface with the compression paddle in place between the source and the ionization chamber.

If the recommended performance criteria are not met, the source of the problem must be identified and corrective action must be taken within thirty days of the test date.

### 3.10 Phantom Image Quality Evaluation

#### 3.10.1 Objective

To assess the quality and consistency of the mammographic image.

#### 3.10.2 Frequency

Annually

#### 3.10.3 Suggested Equipment

- 18 x 24 cm flat compression paddle
- ACR Mammographic Accreditation Phantom
- Acrylic disc, 4.0 mm thick with 1.0 cm diameter to place on the top of the ACR Mammographic Accreditation Phantom



#### Note

The ACR mammographic accreditation phantom is used for breast tomosynthesis image quality evaluation since it is readily available to medical physicists and radiologic technologists, and to ensure consistent image performance in tomosynthesis imaging over time.

---

#### 3.10.4 Test Procedure



#### Note

Before performing an image quality test, the system must change status from Detector Warming to All Ready.

---



1. Select **Admin>Quality Control>Physicist tab>Phantom Image Quality** procedure on the Acquisition Workstation.
2. Select the **Start** button.
3. Install the 18 x 24 cm flat compression paddle in the compression device.
4. Center the ACR phantom laterally on the image receptor and position it so that the chest wall edge of the phantom is aligned with the chest-wall edge of the image receptor.



- Place the 1 cm diameter acrylic disk on top of the phantom in a uniform region that does not cover any portion of the AEC sensor or any of the details in the phantom. An example of an adequate position is the center of the uniform area between the two largest and two smallest fibers (see the following two figures). Once an adequate position has been determined, the acrylic disk can be permanently affixed to the phantom using glue.



Figure 6: Placement of acrylic disc on phantom

- Select **None** at the device Output Group if you do not wish to store the Quality Control images. Select an alternative **Output Group** if you wish to store them.
- Select an **ACR Phantom Conv** (Tomosynthesis Option: **ACR Phantom Combo**) view from the Procedure screen on the Acquisition Station. When using this view, the system assumes that an ACR phantom is being imaged and will set the acquisition technique appropriate for ACR phantom imaging, regardless of the compression thickness. In that case, the compression thickness can be higher than 4.2 cm since it no longer determines the acquisition technique. However, it is recommended that the compression paddle is kept as low as possible with some amount of compression force applied, so that the ACR phantom is still firmly compressed and does not move during the image acquisition.
- Set techniques for the acquisition:



Table 25: Phantom Image Exposure Techniques

Mode	Focal spot	AEC Sensor Position	Compensation Step
Auto-Filter	Large	2	0

Table 26: Phantom Image Exposure Techniques (Tomosynthesis Option)

Mode	Focal spot	AEC Sensor Position	Compensation Step
Auto-Filter	Large	2	0





9. Acquire an image in the selected AEC mode.
10. Record the kVp, mAs, filter, and exposure index in the record form
11. Switch to the tomosynthesis reconstruction preview and repeat step 8 for the tomosynthesis part of the acquisition (Tomosynthesis Option).
12. Accept the image in the Procedure screen on the Acquisition Workstation.
13. Move to the "Data Analysis and Interpretation" section.
14. Select the **End QC** button to mark the Quality Control procedure as completed when you are done with Data Analysis and Interpretation.

**3.10.5 Record Forms**

Use the "Phantom Image Quality Evaluation" form in Appendix A to record the results.

**3.10.6 Data Analysis and Interpretation**

Refer to Appendix F, Scoring a Phantom.

**3.10.7 Recommended Performance Criteria and Corrective Action**

If the phantom score fails to meet the recommended criteria as specified below, the source of the problem must be identified and corrective action must be taken before any further examinations are performed.

**Acceptance Score for Conventional ACR Phantom Image:**

*Table 27: ACR Mammography Accreditation Phantom Minimum Passing Score*

ACR Mammography Accreditation Phantom	Fibers	Speck Groups	Masses
Minimum Passing Score	5.0	4.0	4.0

There may be small fluctuations in scoring of the fibers and masses due to phantom variations. If the fiber score is 4.5 and or the mass score is 3.5, then examine the SNR and high contrast resolution of the system. If both those exceed recommended criteria, then a total score of 4.5 fibers, 4.0 specs and 3.5 masses is acceptable.

**Acceptance Score for Tomosynthesis ACR Phantom Image:**

The phantom image quality in the tomosynthesis acquisition must meet the passing score shown below (Tomosynthesis option):

*Table 28: ACR Mammography Accreditation Phantom Minimum Passing Score (Tomosynthesis Option)*

ACR Mammography Accreditation Phantom	Fibers	Speck Groups	Masses
Minimum Passing Score	4.0	3.0	3.0



## 3.11 Signal-To-Noise and Contrast-To-Noise Measurements

### 3.11.1 Objective

To assure consistency of the digital image receptor by evaluating the signal-to-noise ratio (SNR) and contrast-to-noise ratio (CNR) of the image receptor.

### 3.11.2 Frequency

Annually

### 3.11.3 Suggested Equipment

- 18 x 24 cm flat compression paddle
- ACR Mammographic Accreditation Phantom
- Acrylic disc, 4.0 mm thick with 1.0 cm diameter to place on the top of the ACR Mammographic Accreditation Phantom

### 3.11.4 Test Procedure

#### Select an ACR Phantom Image

You have a choice to use either a previously acquired ACR Phantom image or acquire a new ACR phantom image for this test procedure.

#### Using a Previously Acquired ACR Phantom Image

1. From the Select Patient screen, select the **QC tab**.
2. Select the previously acquired **Phantom Image Quality Evaluation** exam with the correct completed date and time.
3. Select the **Open** button.
4. Select the first **ACR Phantom Conv** (Tomosynthesis Option: **ACR Phantom Combo**) thumbnail image to display in the Preview screen.



#### Note

When selecting between either the **ACR Phantom Conv** or **ACR Phantom Combo** views, ensure that the radiologic technologist uses the same view for the weekly SNR/CNR test.

---

### Acquire a New ACR Phantom Image

---



#### Note

Before performing an image quality test, the system must change status from Detector Warming to All Ready.

---

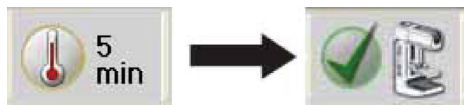

1. Install the 18 × 24 cm flat compression paddle in the compression device.
2. Center the ACR phantom laterally on the image receptor and position it so the chest wall edge of the phantom is aligned with the chest wall side of the image receptor.
3. Place the 1 cm diameter acrylic disc on top of the phantom in a uniform region that does not cover any portion of the AEC sensor or any of the details in the phantom. An example of an adequate position is the center of the uniform area between the two largest and two smallest fibers (see the following figure). Once an adequate position has been determined, the acrylic disc can be permanently affixed to the phantom using glue.



*Figure 7: Placement of acrylic disc on phantom*

4. Lower the compression device so that the compression paddle sits on the ACR phantom.
5. From the Select Patient screen, select **Admin > Quality Control > Physicist tab > SNR/CNR** on the Acquisition Workstation. Click **Start**.

6. Select an **ACR Phantom Conv** view from the Procedure screen on the Acquisition Station. When using this view, the system assumes that an ACR phantom is being imaged and sets the acquisition technique appropriate for ACR phantom imaging. In this case, the compression thickness can be higher than 4.2 cm since it no longer determines the acquisition technique. However, it is recommended that the compression paddle is as low as possible with some amount of compression force applied, so that the ACR phantom is still firmly compressed and does not move during the image acquisition.
7. Set the techniques for the acquisition:

Table 29: Signal-to-Noise and Contrast-to-Noise Exposure Techniques

Mode	Focal spot	Exposure Compensation	AEC Sensor	Grid
AEC Auto-Filter	Large	0	2	In

8. Acquire an image using the **ACR Phantom Conv** view.
9. Accept the image in the Procedure screen on the Acquisition Workstation.

### Select the ROI Creation Method

You have a choice to use either the Automatic or Manual ROI method after acquiring the ACR Phantom image.

#### Automatic ROI Creation

When you use the ACR Phantom view to acquire an image, the system assumes that an ACR Phantom is being imaged and activates the SNR button to the Tools tab window on the Procedure screen. The system automatically acquires and computes the SNR and CNR values.

# Quality Control Manual for Selenia Dimensions and 3Dimensions Systems

## Chapter 3: Quality Control Activities for the Medical Physicist

1. Select the SNR button () The system places two ROI boxes on the image and displays SNR, CNR and corresponding information used for the calculations (see following figure).



### Note

If the ROIs placed automatically by the system do not match the relative positions as displayed in the previous figure, you can manually adjust the location of the ROIs. The SNR and CNR results are recalculated automatically.

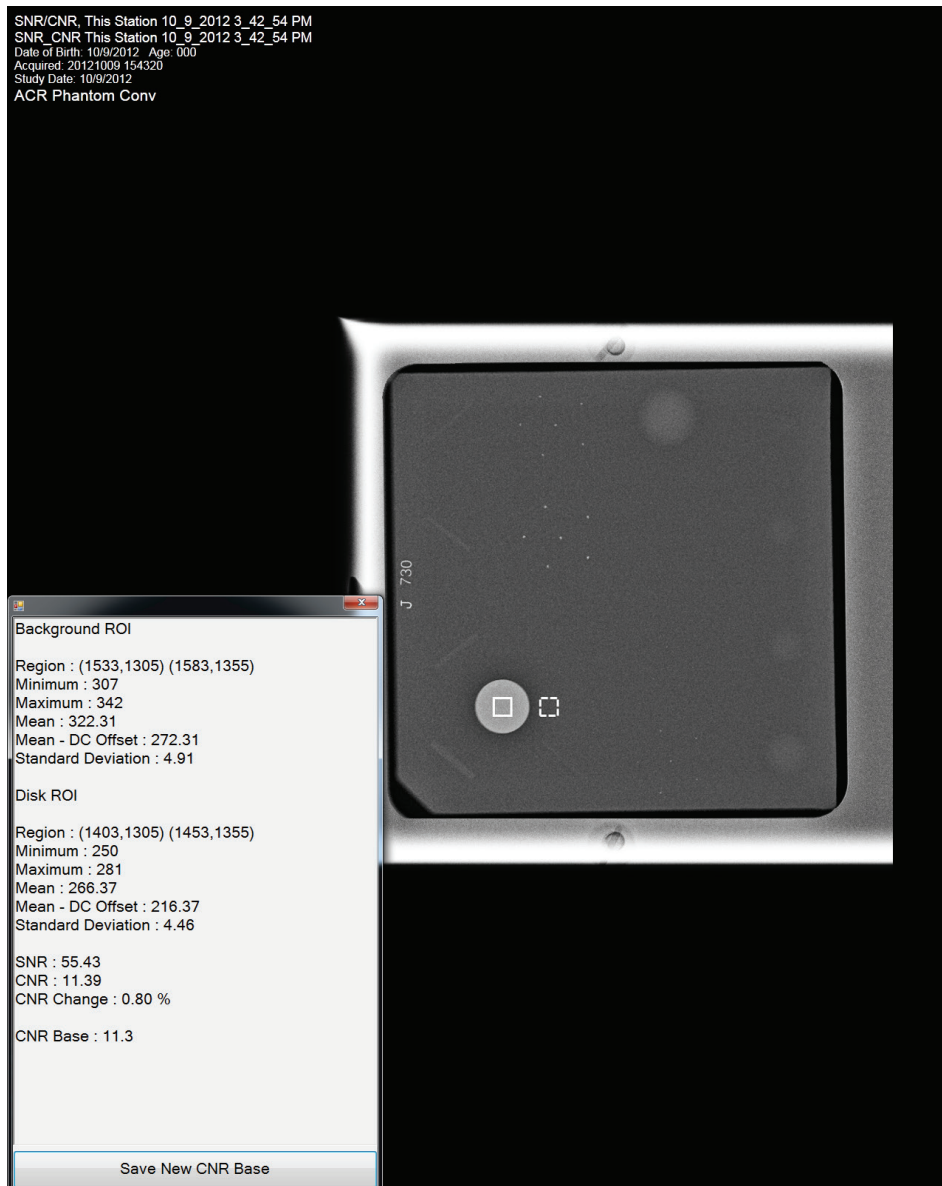

Figure 8: SNR Results Dialog Box

### Manual ROI Creation

1. Select the **ROI tab** on the Procedure screen.
2. Select **Draw** or **64** and use the trackball to draw an ROI on the preview image completely inside the acrylic disk. The ROI window displays the available ROI information (see the following figure).

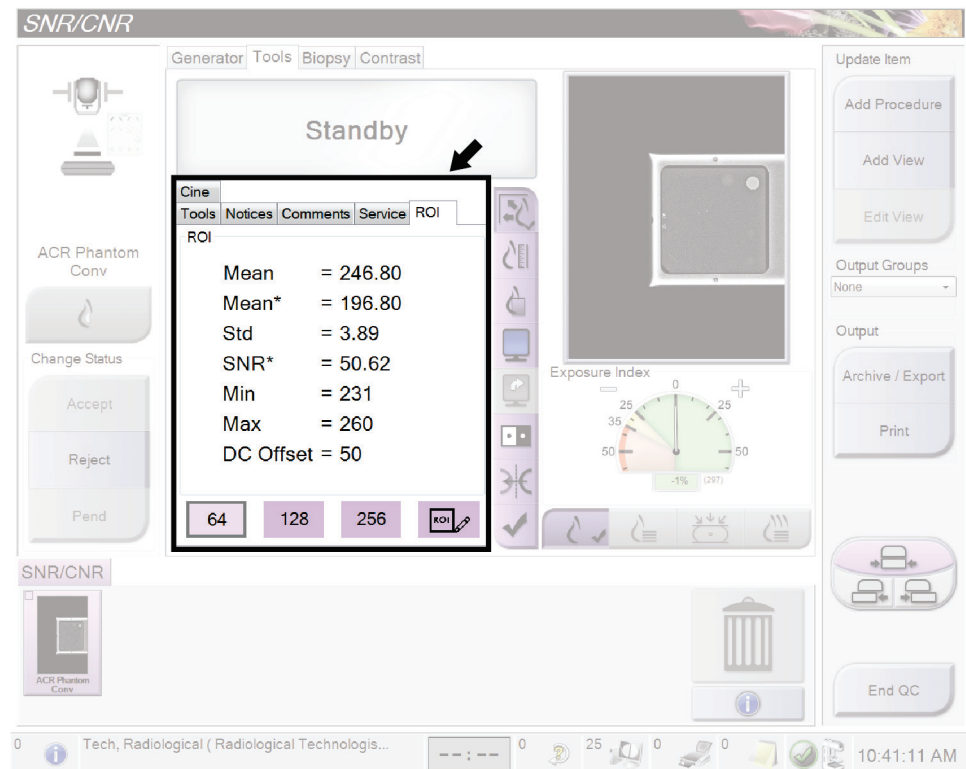

Figure 9: ROI Information Screen

3. Record the mean value (Mean) given in the ROI window.
4. Drag the previously drawn ROI right next to the acrylic disk, towards the chest wall, as shown in the SNR Results Dialog Box figure in the previous Automatic ROI Creation topic.
5. New ROI Statistics appear in the ROI window.
6. Record the mean value (Mean), the SNR, and the standard deviation (Std).

### Update the Quality Control Data on the Acquisition Workstation

- If you used a previously acquired ACR Phantom Image for your test:
  - a. From the Select Patient screen, select **Admin > Quality Control > Physicist tab > All > SNR/CNR – Physicist**.
  - b. Select the **Mark Completed** button to label the status of this procedure as finished. Select the **Yes** button to mark the Quality Control procedure as completed.
- If you acquired a new ACR Phantom Image for your test, select the **End QC** button to mark the Quality Control procedure as completed when you are done with Data Analysis and Interpretation.

### 3.11.5 Record Forms

Use the "Signal-To-Noise Ratio (SNR) and Contrast-To-Noise Ratio (CNR)" form in Appendix A to record the results.

### 3.11.6 Data Analysis and Interpretation

#### Automated Method

With the automated SNR and CNR function, the SNR and CNR are calculated automatically for an appropriately acquired phantom view. The values of SNR and CNR, as well as the ROIs used for the measurement are displayed. The user should check if the ROIs selected by the program are in the appropriate locations. If they are well positioned, record the SNR and CNR values. If the location of one ROI or both ROIs need to be adjusted, move the ROI(s) to the appropriate location and the SNR and CNR values will be automatically updated based on the new ROI location.



---

#### Note

The calculation of the SNR value displayed by the automated method already accounts for the DC offset.

---

#### Manual Method (for reference use only)

---



#### Note

The SNR must be computed using the mean and standard deviation values obtained from the ROI next to the acrylic disk.

---

1. Compute the SNR of the detector according to

$$SNR = \frac{mean_{background} - DC_{offset}}{std_{background}}$$

where  $mean_{background}$  and  $std_{background}$  are the mean and standard deviation obtained from the ROI Statistics dialog for the ROI next to the acrylic disk and  $DC_{offset}$  is a DC offset added to the detector signal and is equal to 50.



2. Compute the CNR of the detector according to

$$CNR = \frac{mean_{background} - mean_{disk}}{std_{background}}$$

where  $mean_{disk}$  is the mean value obtained from the ROI Statistics dialog for the ROI on the acrylic disk.

3. Compute the CNR difference according to

$$Diff = \frac{CNR_{measured} - CNR_{base}}{CNR_{base}} \times 100$$

where CNR is the CNR computed in step 2 and  $CNR_{base}$  is the CNR recorded during the equipment evaluation when the image receptor was installed or after a major upgrade.

### 3.11.7 Recommended Performance Criteria and Corrective Action

The measured SNR must be equal to or greater than 40. If it is less than 40, repeat the test.

The computed CNR must be within  $\pm 15\%$  of the value determined by the medical physicist during the equipment evaluation when the image receptor was installed or after a major upgrade.

If these criteria are not met, a qualified service engineer must correct the problem before using the system for clinical imaging.



**Note**

When CNR is being computed for the first time on a digital detector, the computed value must be used to establish the base criteria for the technologist Signal-To-Noise (SNR) and Contrast-To-Noise (CNR) Measurements weekly test. The corresponding form for the technologist must be completed.

---



**Note**

The CNR baseline may need to be evaluated and a new value may need to be established under the following conditions:

- detector replacement
  - detector modification (i.e. power supply replacement, readout sequence replacement, etc.)
  - AEC dose adjustment
  - ACR phantom replacement or alteration (i.e. permanent repositioning of the acrylic disk)
  - any other reason the medical physicist feels that may affect the CNR calculation
-

### 3.12 Diagnostic Review Workstation Quality Control

#### 3.12.1 Objective

To assure consistency of the brightness, contrast and image presentation of the radiologist's diagnostic review workstation.



---

**Note**

This diagnostic review workstation Quality Control procedure does not overwrite any Quality Control procedures defined by the manufacturer of the review workstation in use. Instead, this QC procedure serves as a QC protocol for mammography review workstations that do not have a Quality Control procedure established by their manufacturer. Only in the event that the diagnostic review workstation does not have its own QC procedure or form, does this procedure and form in Appendix B need to be followed.

---



---

**Note**

Hologic review workstations come with their own diagnostic review workstation quality control program defined on a separate Quality Control Manual. Please use that QC manual to perform Quality Control on Hologic review workstations.

---

#### 3.12.2 Frequency

Annually, when applicable.

#### 3.12.3 Suggested Equipment (Applies to CRT and some LCD displays)

Integrated photometer or external photometer.

#### 3.12.4 System Application Consideration

1. At the Acquisition Workstation, select **Admin>Quality Control>Physicist tab>Diagnostic Review Workstation Quality Control**.
2. Select the **Mark Completed** button to label the status of this procedure as finished. Select the **Yes** button to mark the Quality Control procedure as completed.

#### 3.12.5 Proposed Test Procedure for Workstations without Defined Quality Control

The following sections should only be considered if the workstation manufacturer does not provide an approved Quality Control procedure with their diagnostic review workstation.

### Suggested Tests

1. Measure the display white level for each CRT or LCD display.
2. Measure the display black level for each CRT display.
3. Measure the DICOM GSDF compliance for each CRT or LCD display.
4. Measure the white level uniformity performance for each CRT display.



---

#### Note

The room lighting conditions must be similar to those established during diagnostic image review.

---

### Record Forms

Use the "Diagnostic Review Workstation Quality Control" form in Appendix A to record the results.

### Data Analysis and Interpretation

Check that the tests results comply with the recommended performance criteria.

### Recommended Performance Criteria and Corrective Action

#### White Level Performance

The operating white level must be at:

- 300 cd/m<sup>2</sup> for the Barco MGD521 CRT display
- 400 cd/m<sup>2</sup> for the Barco MGD521M CRT display
- 600 cd/m<sup>2</sup> for the Barco Coronis MFGD 5621 HD Mammo LCD display
- 600 cd/m<sup>2</sup> for the Barco Coronis MDMG 5121 Mammo LCD display
- 1000 cd/m<sup>2</sup> for the Barco MDMG 5221 Tomo LCD display
- 1000 cd/m<sup>2</sup> for the Barco MDMG 12133 Coronis Uniti display
- 500 cd/m<sup>2</sup> for the Barco Coronis MFGD 5421 LCD display
- 500 cd/m<sup>2</sup> for the Barco Nio MDNG-6121 display
- 500 cd/m<sup>2</sup> for the Barco Nio MDNG-5121 display

The tolerance level for white level performance is  $\pm 6\%$ .

If the measured white level is outside the tolerance level, the display must be calibrated and the performance criteria must be met prior to performing mammographic image interpretation on the diagnostic review workstation with the affected display.



---

#### Note

If the displays used by the diagnostic review workstation are not listed in this section, the display manufacturer specifications for calibrated white level apply.

---

### **Black Level Performance (Applies to CRT displays only)**

The operating black level must be less than or equal to 1.0 cd/m<sup>2</sup> for the Barco MGD521 and MGD521M displays.

If the measured black level is outside the tolerance level, the display must be calibrated and the performance criteria must be met prior to performing mammographic image interpretation on the diagnostic review workstation with the affected display.

### **Quality Level Performance, Compliance Test (DICOM GSDF Compliance Check)**

The operating DICOM GSDF compliance of each display must not exceed a total difference of 10%.

If the measured quality level is outside the tolerance level, the display must be calibrated and the performance criteria must be met prior to performing mammographic image interpretation on the diagnostic review workstation with the affected display.



---

#### **Note**

If the displays used by the diagnostic review workstation are not listed in this section, the display manufacturer specifications for calibrated black level applies.

---

### **Uniformity Performance (Applies to CRT displays only)**

The brightness deviation from the brightness of the center of the display for the Barco MGD521 and MGD521M displays must not exceed 15%.

If the measured non-uniformities are outside the tolerance level, the display uniformity must be calibrated and the performance criteria must be met prior to performing mammographic image interpretation on the diagnostic review workstation with the affected display.



---

#### **Note**

If the displays used by the diagnostic review workstation are not listed in this section, the display manufacturer specifications for uniformity performance applies.

---



---

#### **Note**

A qualified service engineer may have to resolve any issues if tolerance levels cannot be achieved for any of the displays of the diagnostic review workstation.

---



---

#### **Note**

Image acquisition can continue while issues with the diagnostic review workstation are being addressed. Another approved diagnostic device (i.e. DICOM printer, second diagnostic review workstation) must be used for mammographic image interpretation.

---

### 3.13 Detector Ghosting (Troubleshooting Use Only)

#### 3.13.1 Objective

To assure that the level of detector ghosting does not interfere with image quality.



---

**Note**

The Detector Ghosting test is an optional test that may be performed by the medical physicist in the event of appearance or suspicion of detector ghosting.

---

#### 3.13.2 Frequency

When needed for troubleshooting purpose

#### 3.13.3 Suggested Equipment

- Flat Field phantom, 4 cm thick uniform attenuation block of acrylic large enough to cover the digital image receptor. The Flat Field phantom is supplied by the manufacturer.
- 0.1mm sheet of aluminum (for example: the filters which are used for the HVL measurement)
- 24 x 29 cm flat compression paddle

#### 3.13.4 Test Procedure



---

**Note**

Before performing an image quality test, the system must change status from Detector Warming to All Ready.

---



1. Select **Admin>Quality Control>Physicist tab>Detector Ghosting** procedure on the Acquisition Workstation.
2. Select the **Start** button.
3. Install the 24 x 29 cm flat compression paddle in the compression device.

4. Place the Flat Field phantom on top of the image receptor cover positioned such that a little more than half of the digital image receptor is covered and the other half of the digital image receptor is not covered by the Flat Field phantom.

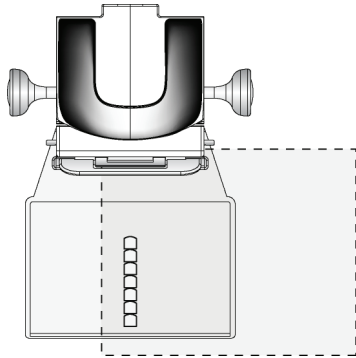

Figure 10: Placement of Flat-Field Phantom on Image Receptor



**Note**

The Flat Field phantom must extend at least 1" beyond the AEC Sensors and cover the sensors.

5. Lower the compression device until the compression paddle is touching the Flat Field phantom.
6. Set the Exposure Techniques:

Table 30: Detector Ghosting Exposure Techniques

Mode	kVp	Filter	Focal spot	Exposure Compensation	AEC Sensor
AEC mode that is used clinically (i.e., Auto-Filter)	Clinically used values, if applicable in the selected AEC mode	Clinically used values, if applicable in the selected AEC mode	Large	0, or the step used clinically	2

7. Select the first **Flat Field Conv** view from the Procedure screen.
8. Acquire an image using the **Flat Field Conv** view.
9. Accept the preview image.
10. Move the Flat Field phantom so that it covers the entire image area of the digital image receptor.

11. Place the 0.1 mm aluminum filter on top of the standard block centered against the chest wall edge of the digital image receptor.

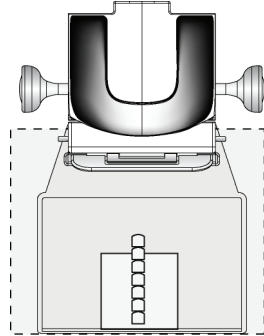

Figure 11: Placement of Aluminum Filter on Standard Block on Image Receptor

12. Select the second **Flat Field Conv** view from the Procedure screen and acquire an image about 1 minute after the completion of the first exposure.
13. Select the **ROI tab** on the Procedure screen.
14. Select the ROI size **128**.
15. Measure and record the mean pixel value in the ROI on the locations shown in the following figure.

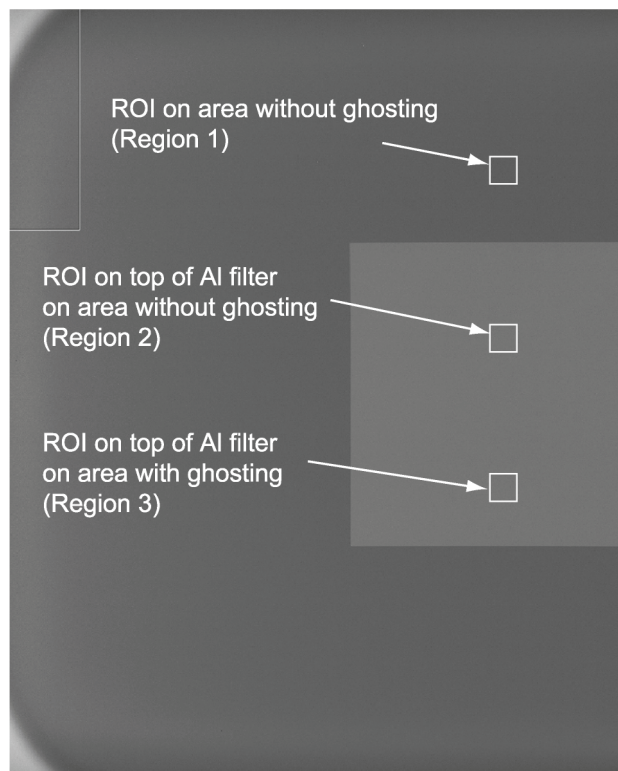

Figure 12: Preview Screen Showing Set-up for Detector Ghosting Test

16. Accept the second image.
17. Move to the "Data Analysis and Interpretation" section.
18. Select the **End QC** button to mark the Quality Control procedure as completed when you are done with Data Analysis and Interpretation.

### 3.13.5 Record Forms

Use the "Detector Ghosting (Optional)" form in Appendix A to record the results.

### 3.13.6 Data Analysis and Interpretation

Calculate the Ghost Image Factor by using the following formula and record in the form.

$$\text{Ghost Image Factor} = \frac{\text{mean}_{\text{region3}} - \text{mean}_{\text{region2}}}{\text{mean}_{\text{region1}} - \text{mean}_{\text{region2}}}$$



---

#### Note

Regions 1 and 2 correspond to the section of the detector that was covered by the Flat Field phantom during both exposures. Region 3 corresponds to the section of the detector that was covered by the Flat Field phantom during only one of the two exposures.

---

### 3.13.7 Recommended Performance Criteria and Corrective Actions

The measured Ghost Image Factor must be within  $\pm 0.3$  for consecutive images acquired within approximately 1 minute of each other. If it is greater, repeat the test.

If the recommended performance criteria are not met, a qualified service engineer must correct the problem before using the system for clinical imaging.



## Chapter 4 Quality Control Activities for the Radiologic Technologist

This section specifies the Quality Control procedures, testing frequency, regulatory action levels and time limits for corrective action for each required Quality Control Activity that falls under the responsibility of the *radiologic technologist*. Detailed steps are provided only for Quality Control procedures that are different from the standard Quality Control procedures already in use for screen-film mammography facilities.

All tests under the *Quality Control Activities for the Radiologic Technologist* section must be performed at the specified frequency by a qualified radiologic technologist trained in digital mammography.



**Note**

Please read the *User Guide* to become familiar with the user interface and functionality of the system.



**Note**

Quality Control activities are organized in the system application for medical physicist and radiologic technologist, respectively. The medical physicist and the radiologic technologist should go to the Quality Control list at **Admin>Quality Control** and select the procedure to be performed. The procedure from the Quality Control list is configured to provide the proper image views and acquisition techniques that are needed for the selected test.



**Note**

Any steps in the QC test procedures that are specific to breast tomosynthesis are

indicated by the wording "Tomosynthesis Option" and the  icon on the side of the page. Such steps only apply to systems that are licensed to perform tomosynthesis procedures.



**Note**

Any steps in the QC test procedures that make use of the SFS are indicated by the  icon on the side of the page. Such tests only apply to systems that are licensed to perform diagnostic procedures.



**Note**

Any steps in the QC test procedures that are specific to contrast enhanced digital

mammography are indicated by the wording "CE2D Option" and the  icon on the side of the page. Such steps only apply to systems that are licensed to perform contrast enhanced digital mammography procedures.

# Quality Control Manual for Selenia Dimensions and 3Dimensions Systems

## Chapter 4: Quality Control Activities for the Radiologic Technologist

---



---

### Note

Before performing an image quality test, the system must change status from Detector Warming to All Ready.

---



---

### Caution:

Direct exposure of the digital detector to high radiation dose may damage the detector. The digital image receptor must be covered with lead during testing for exposures other than those required to qualify image quality. Following the test procedures in this Quality Control Manual will ensure the safety of the digital detector.

---

## 4.1 DICOM Printer Quality Control

### 4.1.1 Objective

To assure consistency of DICOM printer performance. This procedure is analogous to film processor Quality Control, performed on traditional film processors used to process mammograms.



---

**Note**

The intention of printing the SMPTE pattern is not to evaluate the pattern itself and if it conforms to the SMPTE standards, but to give the user the opportunity to measure different density areas to track the printer stability over time as well as verify that software changes to either the printer or the system did not alter the interface configuration. Thus, it is important that the SMPTE pattern is printed from the system and not from the printer itself.

---

### 4.1.2 Frequency

Weekly or after software changes have been installed to the DICOM printer or to a mammography system.



---

**Note**

If the facility does not own or use a printer, the DICOM Printer Quality Control test is not required. If the facility is using the printer in association with a mammography system sporadically, the facility must perform this test prior to using the printer to print clinical images.

---



---

**Note**

If you have multiple or combined systems, you only need to perform this test from a single system each week, preferably the same system every week.

---



---

**Note**

This test must be performed every time a software change takes place on a mammography system or the printer itself. If the facility does not own or use a printer, the DICOM Printer Quality Control test is not required every time a software change takes place. If software changes affected a mammography system, then that system must be used for performing this one time test, independently of the weekly frequency of this test. The default mammography system may be used for the following weekly test.

---

### 4.1.3 Suggested Equipment

- Densitometer
- SMPTE test pattern stored on the Acquisition Workstation

### 4.1.4 Test Procedure

1. Select **Admin>Quality Control>Technologist tab>DICOM Printer Quality Control** procedure on the Acquisition Workstation. Select **Start**.
2. Select the **SMPTE** pattern as the test pattern.
3. Select the image size: **2560 x 3328**.
4. Select the **DICOM Device** printer from the Output list and select **8 x 10 inch** or **18 x 24 cm** film.
5. Under Options, uncheck **True Size Printing** if available.
6. Select **Send** to print the SMPTE pattern on the selected printer.
7. Repeat the test for all other printers used for printing clinical images.
8. Select **Back**. Select **Yes** or **No** to confirm completion of the selected procedure.

### 4.1.5 Record Forms

Use the "DICOM Printer Quality Control" form in Appendix B to record the results.

#### 4.1.6 Data Analysis and Interpretation

1. Use the densitometer to measure the density of the 10%, 40% and 90% patches, as shown in the following figure, on the SMPTE film. Record the results on the test film and date the film if necessary.
2. Determine and plot the Mid Density (MD), Density Difference (DD) and Lower Density (LD) values on the *DICOM Printer Control Chart*.
  - For MD, use the density measured for the 40% patch.
  - For LD, use the density measured for the 90% patch.
  - For DD, subtract the density of the 40% patch from the density of the 10% patch.

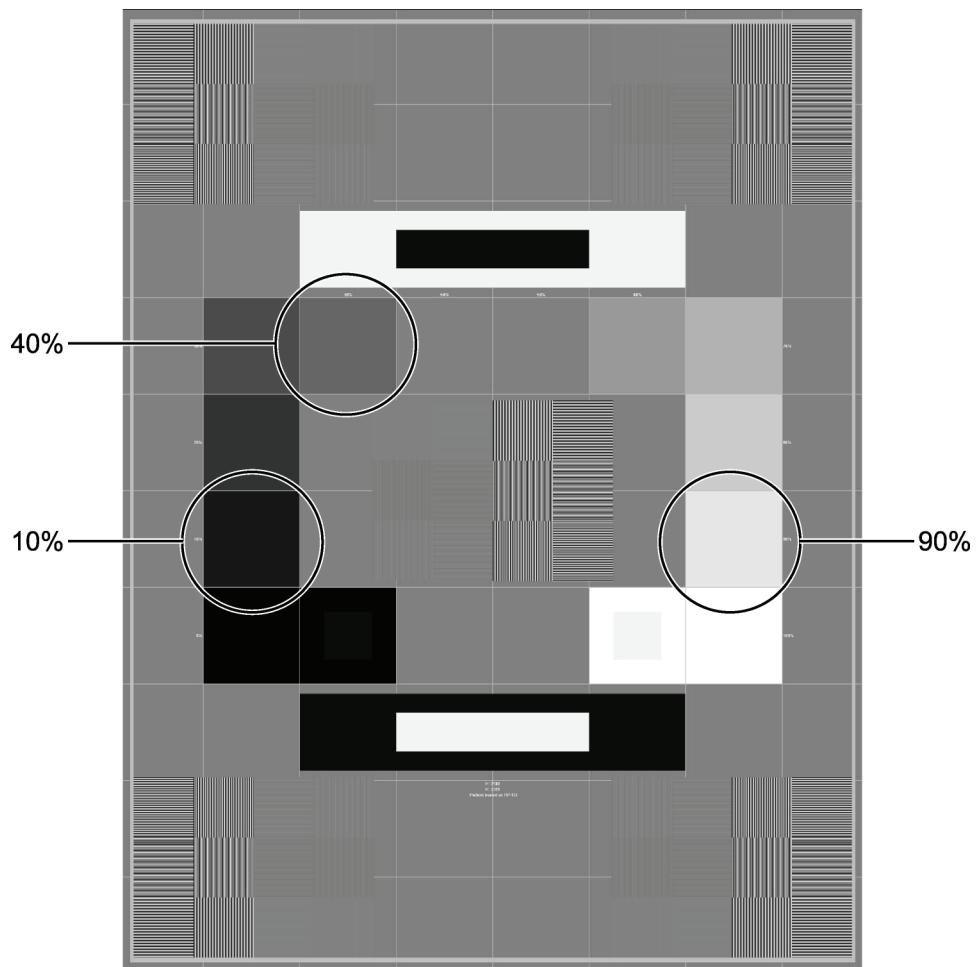

Figure 13: SMPTE Pattern

You may use the “Data Collection Worksheet” in Appendix B to record your values.

#### **4.1.7 Recommended Performance Criteria and Corrective Action**

Operating levels must be established under the supervision of the medical physicist or during application training. Operating levels must be established separately for each printer.

The Mid Density, Density Difference and Lower Density values must track over time within  $\pm 0.15$  of the established standards as shown in the table below.

*Table 31: Density Standards*

<b>Control Value</b>	<b>SMPTE Grayscale Patch</b>	<b>Control Limits</b>
MD	40%	$\pm 0.15$
DD	10% - 40%	$\pm 0.15$
LD	90%	$\pm 0.15$

If any of the values are beyond their respective control limits, repeat the test after recalibrating the printer.

If the test results fall outside the control limits, the source of the problem must be identified by a qualified DICOM printer service engineer. Corrective actions must be taken before printing any more clinical or phantom films on this DICOM printer.

Images can still be acquired while any printer issues are being resolved. Alternative diagnostic devices must be used for mammographic image interpretation until all issues are resolved and the DICOM printer performs within recommended criteria.

## 4.2 Detector Flat Field Calibration

### 4.2.1 Objective

To assure that the system is calibrated properly.

### 4.2.2 Frequency

Weekly

### 4.2.3 Suggested Equipment

Flat Field phantom: 4 cm thick uniform attenuation block of acrylic large enough to cover the digital image receptor. The Flat Field phantom is supplied by the manufacturer.

### 4.2.4 Test Procedure

#### Preparation

1. If the system was recently or just powered up, wait the posted time required for the digital detector to come up to temperature.



---

#### Note

Before performing an image quality test, the system must change status from Detector Warming to All Ready.

---



2. Remove any compression paddle from the compression device.
3. Move the compression device at a distance between 5 and 7 cm above the image receptor as indicated by the thickness display.
4. Make sure that both the Flat Field phantom and the surface of the image receptor are clean. Place the Flat Field phantom on top of the image receptor covering its entire surface.



---

#### Note

It is important to clean the Flat Field phantom and the surface of the digital image receptor before starting the calibration procedure.

---

### Calibration Procedure

1. Select **Admin>Quality Control>Technologist tab>Gain Calibration** procedure on the Acquisition Workstation.
2. Select **Start**.
3. Follow the instructions on the screen and take the first predefined exposure. Do not change the preselected techniques unless otherwise instructed.
4. If you are instructed to install the magnification platform, use the 1.8x insertion points.
5. Review the preview image for foreign objects, gross artifacts other than non-uniformities or collimation interference.
6. Select **Accept** if the image is clean and the collimation blades do not intrude into the imaging space.
7. Repeat Step 3 to Step 6 until all predefined exposures are acquired.

**D<sub>x</sub>**



---

#### Note

All predefined exposures need to be completed for the Detector Flat Field Calibration to be completed successfully. Ending the calibration sequence in the middle of the procedure will invalidate the current Detector Flat Field Calibration and revert back to the previous calibration.

---

8. After acquiring and accepting the last predefined exposure, select **End Calibration**.
9. Select **Admin>Quality Control>Technologist tab>CEDM Gain Calibration** procedure on the Acquisition Workstation.
10. Repeat Steps 2 to 8.



### 4.2.5 Record Forms

It is not required to record the execution of this test since the system keeps track of when the test was performed last and prohibits manual removal of the test from the Due test list. However, a "Detector Flat Field Calibration" form is included in Appendix B in case the facility would like to keep track of when this test was performed.



#### **4.2.6 Data Analysis and Interpretation**



---

**Note**

If the calibration fails for any reason, assure that the x-ray field covers the entire surface of the digital image receptor without any interference from the collimation. Assure that the Flat Field phantom also covers the entire surface of the digital image receptor. Calibration failure may also be caused by altering the radiographic techniques between exposures. In the event of calibration failure, start the detector Flat Field calibration procedure from the beginning. If failure persists, a qualified service engineer must be contacted.

---

1. Detector Flat Field calibration is performed automatically by software on the Acquisition Workstation from the acquired set of predefined exposures.
2. Disregard any non-uniformities which appear in the acquired calibration images. Any non-uniformities will be corrected as part of the calibration process.

#### **4.2.7 Recommended Performance Criteria and Corrective Action**

If, after calibration, new artifacts appear during imaging, consult with a medical physicist or radiologist for assistance in evaluating these artifacts according to the guidelines provided in this manual under the corresponding Artifact Evaluation sections.

If the calibration procedure fails repeatedly, the source of the problem must be identified and corrective actions must be taken before any further examinations are performed.

## 4.3 Geometry Calibration (Tomosynthesis Option)



**Note**

The Tomosynthesis Option applies to this entire section.

---

### 4.3.1 Objective

To assure that the system is calibrated properly.

### 4.3.2 Frequency

Semiannually

### 4.3.3 Suggested Equipment

Geometry phantom: The Geometry phantom is supplied by the manufacturer.

### 4.3.4 Test Procedure

#### Preparation

1. If the system was recently or just powered up, wait the posted time required for the digital detector to come up to temperature.



**Note**

Before performing an image quality test, the system must change status from Detector Warming to All Ready.

---



**Note**

It is important to clean the Geometry phantom and the surface of the digital image receptor before starting the calibration procedure.

---

2. Remove any compression paddle from the compression device.
3. Install the Geometry phantom on the compression device.
4. Lower the compression device and apply approximately 20 lb (~89N) of compression with the Geometry phantom in place.
5. Verify that the bottom surface of the Geometry phantom is in good contact with the surface of the image receptor.

### Calibration Procedure

1. Select **Admin>Quality Control>Technologist tab>Geometry Calibration** procedure on the Acquisition Workstation.
2. Select **Start**.
3. Follow the instructions on the screen and take the predefined exposure. Do not change the preselected techniques.
4. Accept the image. When you see the message that the geometry calibration was completed successfully, click OK.
5. Select **End Calibration**.

#### 4.3.5 Record Forms

It is not required to record the execution of this test since the system keeps track of when the test was performed last and prohibits manual removal of the test from the Due test list. However, there is a "Geometry Calibration" line in the Monthly, Quarterly, and Semi-Annual QC Checklist form in Appendix B in case the facility would like to keep track of when this test was performed.

#### 4.3.6 Data Analysis and Interpretation

Geometry calibration is performed automatically by software on the Acquisition Workstation.



##### Note

If the calibration fails for any reason, assure that the x-ray field covers the entire surface of the digital image receptor without any interference from the collimation. Assure that the Calibration phantom is correctly installed and pressing on the digital image receptor. In the event of calibration failure, start the geometry procedure from the beginning. If failure persists, a qualified service engineer must be contacted.

---

#### 4.3.7 Recommended Performance Criteria and Corrective Action

If the calibration procedure fails repeatedly, the source of the problem must be identified and corrective actions must be taken before any further tomosynthesis examinations are performed.

## **4.4 Artifact Evaluation**

### **4.4.1 Objective**

To assure that the image is free of undesirable artifacts.

### **4.4.2 Frequency**

Weekly, preferably before Phantom Image Evaluation.

### **4.4.3 Suggested Equipment**

Flat Field phantom: 4 cm thick uniform attenuation block of acrylic large enough to cover the digital image receptor. The Flat Field phantom is supplied by the manufacturer.

### **4.4.4 Test Procedure**

#### **DICOM Printer Artifact Evaluation**

---



**Note**

If the facility does not own or use a printer, the DICOM printer artifact evaluation test is not required. If the facility is using the printer in association with a mammography system sporadically, the facility may select to perform this part of the test only prior to using the printer to print clinical images.

---



**Note**

As an alternative, you can follow the procedure, requirements and recommendations of the printer manufacturer when performing this test.

---



**Note**

If you have multiple mammography systems printing to a single printer, you only need to perform this test from a single system, since this test is used to assess the printer artifact performance and is equivalent regardless of which system is used to perform this test.

---



**Note**

It is recommended that System Artifact Evaluation is executed after Detector Flat Field Calibration when possible.

---



**Note**

When performing DICOM printer artifact evaluation, an artificial flat field must be sent to the printer following the procedure steps below. A true flat field acquired on the mammography system using the Flat Field phantom is not appropriate for this test and must not be used.

---

1. Select **Admin>Test Patterns**.
2. Select the **Flat Field** pattern from the Pattern list as the test pattern.
  - **For 8 x 10 inch (18 x 24 cm) printer film**
    - a. Select the **Image Size: 2560 x 3328**.
    - b. Select the **DICOM printer** device from the Outputs list, and select **8 x 10 inch** or **18 x 24 cm** film.
    - c. Under Options, check **True Size Printing** if available.
    - d. Select the **Send** button to print the flat field pattern on the selected printer.
  - **For 10 x 12 inch (24 x 30 cm) printer film, if supported**
    - a. Select the **Image Size: 3328x4096**.
    - b. Select the **DICOM printer** device from the Outputs list, and select **10 x 12 inch** or **24 x 30 cm** film.
    - c. Under Options, check **True Size Printing** if available.
    - d. Select the **Send** button to print the flat field pattern on the selected printer.
3. Repeat the above steps for all other printers used for printing clinical images.
4. Select the **Back** button to return to the Admin screen.

### System Artifact Evaluation

---



#### Note

Before performing an image quality test, the system must change status from Detector Warming to All Ready.

---



#### Note

It is recommended that System Artifact Evaluation is executed after Detector Flat Field Calibration when possible.

---

**Preparation**

1. Remove any compression paddle and lower the compression device between 5 cm and 7 cm.
2. Make sure that both the Flat Field Phantom and the surface of the image receptor are clean. Place the Flat Field Phantom on top of the image receptor to cover its active surface.
3. Select **Admin>Quality Control>Technologist tab>Artifact Evaluation** procedure on the Acquisition Workstation.
4. Select **Start**.
5. Select **None** at the device Output Set if you do not wish to store the Quality Control images. Select an alternative **Output Set** if you wish to store them.

**Artifact Evaluation with Rhodium (Rh) Filter and Large Focal Spot (LFS)**

1. Select the first **Flat Field Conv** view from the Procedure screen on the Acquisition Workstation.
2. Set the exposure techniques per the following table:

*Table 32: Artifact Evaluation Rh Filter Exposure Techniques*

Mode	kVp	Filter	Focal Spot	AEC Sensor Position
Auto-Time	28	Rh	Large	2

3. Acquire an exposure.
4. Select the **Actual Pixels** button to bring the image into full resolution.
5. Pan through the entire image with patient information turned off. Look for artifacts such as bad pixels or sharp lines of demarcation.
6. Note any technical factors and any artifacts on the record form, then select **Accept**.

**Artifact Evaluation with Silver (Ag) Filter and Large Focal Spot (LFS)**

1. Turn the Flat Field phantom 180°.
2. Lower the compression device between 5 cm and 7 cm.
3. Select the second **Flat Field Conv** view from the Procedure screen on the Acquisition Workstation.
4. Set the exposure technique per the following table:

*Table 33: Artifact Evaluation Ag Filter Exposure Techniques*

Mode	kVp	Filter	Focal Spot	AEC Sensor Position
Auto-Time	31	Ag	Large	2

5. Acquire an exposure.
6. Select the **Actual Pixels** button to bring the image into full resolution.
7. Pan through the entire image with patient information turned off. Look for artifacts such as bad pixels or sharp lines of demarcation.
8. Note any technical factors and any artifacts on the record form, then select **Accept**.



**Artifact Evaluation (Tomosynthesis Option)**

1. Lower the compression device between 5 cm and 7 cm.
2. Select the **Flat Field Tomo** view from the Procedure screen on the Acquisition Workstation.
3. Set the exposure technique per the following table:

*Table 34: Artifact Evaluation Al Filter Exposure Techniques (Tomosynthesis Option)*

Mode	kVp	Filter	Focal Spot	AEC Sensor Position
Auto-Time	30	Al	Large	2

4. Acquire an exposure.
5. Scroll to the center projection located around 0 degrees and select the **Actual Pixels** button to bring the image into full resolution.
6. Pan through the entire image with patient information turned off. Look for artifacts such as bad pixels or sharp lines of demarcation.
7. Note any technical factors and any artifacts on the record form, then select **Accept**.



### Artifact Evaluation (CE2D Option)

1. Lower the compression device between 5 cm and 7 cm.
2. Select the Flat **Field CEDM view** from the Procedure screen on the Acquisition Workstation.
3. Set the exposure technique per the following table:

Table 35: Artifact Evaluation Cu Filter Exposure Techniques (CE2D Option)

Mode	kVp	mAs	Filter	Focal Spot
Manual	28	100	Rh	Large



#### Note

The CE2D modality is only compatible with Manual and Auto-Filter AEC modes.

4. Acquire an exposure.
5. If the dual-energy subtracted image is displayed after acquisition, select the **Contrast** tab. Select the  button (typically used to show the low-energy image for patient CEDM views) to display the Cu filter exposure.
6. Select the **Actual Pixels** button to bring the image into full resolution.
7. Pan through the entire subtracted image with patient information turned off. Look for artifacts such as bad pixels or sharp lines of demarcation.
8. Note any technical factors and any artifacts on the record form, then select **Accept**.

#### Complete the Procedure

1. Move to the "Data Analysis and Interpretation" section.
2. Select the **End QC** button to mark the Quality Control procedure as completed when you are done with data analysis and interpretation.

### 4.4.5 Record Forms

Use the "System Artifact Evaluation" and "Printer Artifact Evaluation" forms in Appendix B to record the results.

### 4.4.6 Data Analysis and Interpretation

#### DICOM Printer Artifact Evaluation

Inspect the DICOM printer film for streaks, lines, smudges, spots, and other artifacts on the image caused by the printing process.



### System Artifact Evaluation

---



#### Note

Acquiring an image for artifact evaluation using a Flat Field view sets the image window to 500 and the image level to the exposure index automatically. Artifact evaluation must be performed under these predefined settings.

---

1. View the images on the Acquisition Workstation display. If no artifacts are visible, document the result in the Artifact Evaluation form.
2. If any artifacts are visible, rotate the Flat Field phantom about 180° and repeat the above test procedure. If the appearance of any artifacts changes location between the two images, those artifacts are present in the phantom, and do not indicate problems in system performance. The appearance of persistent artifacts in the same location may indicate artifacts that originate in the x-ray system or digital image receptor.
3. View the overall image for uniformity from left to right and top to bottom. Any areas appearing different with sharp lines of demarcation between them indicates a digital image receptor problem. Perform a detector calibration and then repeat the Artifact Evaluation Test.
4. If such artifacts persist, ask your medical physicist to perform a system artifact analysis, described in the "Quality Control Activities for the Medical Physicist" section of this manual.
5. Document the appearance of any artifacts on the "Artifact Evaluation" form.

#### 4.4.7 Recommended Performance Criteria and Corrective Action

A qualified service engineer must correct the source of intolerable artifacts on the DICOM printer within thirty days of the test date.

Artifacts that are traced to the digital image receptor or the x-ray unit must be eliminated by a qualified service engineer within thirty days of the test date. If artifacts cannot be eliminated, the medical physicist must consult with the radiologist for assistance in evaluating whether any remaining artifacts may interfere with image interpretation or may be tolerable.



#### Note

Artifacts that appear on the digital image receptor and are not dropped pixels or lines may be able to be removed by recalibrating the digital detector according to [Detector Flat Field Calibration](#) on page 89 of this manual.

---



#### Note

Artifacts that appear on the Flat Field phantom provided by the manufacturer must not be overlooked. Such artifacts will have an impact on detector calibration since the same block is being used during detector calibration. Replacement of the Flat Field phantom must be considered.

---

### 4.5 Phantom Image

#### 4.5.1 Objective

To assess the quality and consistency of the mammographic image.

#### 4.5.2 Frequency

Weekly

#### 4.5.3 Suggested Equipment

- 18 x 24 cm flat compression paddle
- ACR Mammographic Accreditation Phantom
- Acrylic disc, 4.0 mm thick with 1.0 cm diameter to place on the top of the ACR Mammographic Accreditation Phantom



---

#### Note

The ACR mammographic accreditation phantom is used for breast tomosynthesis image quality evaluation since it is readily available to medical physicists and radiologic technologists, and to ensure consistent image performance in tomosynthesis imaging over time.

---

#### 4.5.4 Test Procedure



---

#### Note

Before performing an image quality test, the system must change status from Detector Warming to All Ready.

---



1. Select **Admin>Quality Control>Technologist tab>Phantom Image Quality** procedure on the Acquisition Workstation.
2. Select the **Start** button.
3. Install the compression paddle in the compression device.
4. Center the ACR phantom laterally on the image receptor and position it so that the chest wall edge of the phantom is aligned with the chest-wall edge of the image receptor.

- Place the 1 cm diameter acrylic disc on top of the phantom in a uniform region that does not cover any portion of the AEC sensor or any of the details in the phantom. An example of an adequate position is the center of the uniform area between the two largest and two smallest fibers (see the following figure).



Figure 14: Placement of acrylic disc on phantom



- Select **None** at the device Output Set if you do not wish to store the Quality Control images. Select an alternative **Output Set** if you wish to store them.
- Select an **ACR Phantom Conv** (Tomosynthesis Option: **ACR Phantom Combo**) view from the Procedure screen on the Acquisition Station. When using this view, the system assumes that an ACR phantom is being imaged and will set the acquisition technique appropriate for ACR phantom imaging, regardless of the compression thickness. In that case, the compression thickness can be higher than 4.2 cm since it no longer determines the acquisition technique. However, it is recommended that the compression paddle is kept as low as possible with some amount of compression force applied, so that the ACR phantom is still firmly compressed and does not move during image acquisition.
- Set techniques for the acquisition:

Table 36: Phantom Image Exposure Techniques

Mode	Focal Spot	AEC Sensor Position	Compensation Step
Auto-Filter	Large	2	0



Table 37: Phantom Image Exposure Techniques (Tomosynthesis Option)

Mode	Focal Spot	AEC Sensor Position	Compensation Step
Auto-Filter	Large	2	0



9. Acquire an exposure in the selected AEC mode.
10. Record the kVp, mAs, filter, and exposure index for the acquisition.
11. Switch to the tomosynthesis reconstruction preview and repeat Step 10 for the tomosynthesis part of the acquisition (Tomosynthesis Option).
12. Move to the "Data Analysis and Interpretation" section.
13. Accept the Image in the Procedure screen on the Acquisition Workstation.
14. Select the **End QC** button to mark the Quality Control procedure as completed when you are done with Data Analysis and Interpretation.

**4.5.5 Record Forms**

Use the "Phantom Control Chart" and/or "Phantom Control Chart (Tomosynthesis Option)" forms in Appendix B to record the results.

**4.5.6 Data Analysis and Interpretation**

Refer to Appendix F, Scoring a Phantom.

**4.5.7 Recommended Performance Criteria and Corrective Action**

If the phantom score fails to meet the recommended criteria as specified below, the source of the problem must be identified and corrective action must be taken before any further examinations are performed.

**Acceptance Score for Conventional ACR Phantom Image:**

*Table 38: ACR Mammography Accreditation Phantom Minimum Passing Score*

ACR Mammography Accreditation Phantom	Fibers	Speck Groups	Masses
Minimum Passing Score	5.0	4.0	4.0

There may be small fluctuations in scoring of the fibers and masses due to phantom variations. If the fiber score is 4.5 and or the mass score is 3.5, then examine the SNR and CNR of the system. If both those exceed recommended criteria, then a total score of 4.5 fibers, 4.0 specs and 3.5 masses is acceptable.

**Acceptance Score for Tomosynthesis ACR Phantom Image:**

The phantom image quality in the tomosynthesis acquisition must meet the passing score shown below (Tomosynthesis option):

*Table 39: ACR Mammography Accreditation Phantom Minimum Passing Score (Tomosynthesis Option)*

ACR Mammography Accreditation Phantom	Fibers	Speck Groups	Masses
Minimum Passing Score	4.0	3.0	3.0



## 4.6 Signal-To-Noise and Contrast-To-Noise Measurements

### 4.6.1 Objective

To assure consistency of the digital image receptor by evaluating the signal-to-noise ratio (SNR) and contrast-to-noise ratio (CNR) of the image receptor.

### 4.6.2 Frequency

Weekly

### 4.6.3 Suggested Equipment

- 18 x 24 cm flat compression paddle
- ACR Mammographic Accreditation Phantom
- Acrylic disc, 4.0 mm thick with 1.0 cm diameter to place on the top of the ACR Mammographic Accreditation Phantom

### 4.6.4 Test Procedure

#### Select an ACR Phantom Image

You have a choice to use either a previously acquired ACR Phantom image or acquire a new ACR phantom image for this test procedure.

#### Using a Previously Acquired ACR Phantom Image

1. If the ACR Phantom image is still open, proceed to step 6.
2. From the Select Patient screen, select the **QC** tab.
3. Select the previously acquired **Phantom Image Quality Evaluation** exam with the correct completed date and time.
4. Select the **Open** button.
5. Select the **ACR Phantom Conv** (Tomosynthesis Option: **ACR Phantom Combo**) thumbnail image to display in the Preview screen.
6. Select the **SNR** button.
7. Record the SNR. Record the CNR Change percentage.



### Acquire a New ACR Phantom Image

---



#### Note

Before performing an image quality test, the system must change status from Detector Warming to All Ready.

---



1. Install the 18 × 24 cm flat compression paddle in the compression device.
2. Center the ACR phantom laterally on the image receptor and position it so the chest wall edge of the phantom is aligned with the chest wall side of the image receptor.
3. Place the acrylic disc on the top of the phantom in a consistent location in the image area so it will not obscure details in the phantom and where it cannot cast a shadow on any portion of the AEC detector. A suitable location is between and slightly below the first and second largest fibers (see the following figure).



Figure 15: Placement of acrylic disc on phantom

4. Lower the compression device so that the compression paddle sits on the ACR phantom.
5. From the Select Patient screen, select **Admin > Quality Control > Technologist tab > SNR/CNR** on the Acquisition Workstation. Click **Start**.
6. Select **None** at the device Output Group if you do not wish to store the Quality Control images. Select an alternative **Output Group** if you wish to store them.

7. Select an **ACR Phantom Conv** view from the Procedure screen on the Acquisition Station. When using this view, the system assumes that an ACR phantom is being imaged and sets the acquisition technique appropriate for ACR phantom imaging. In this case, the compression thickness can be higher than 4.2 cm since it no longer determines the acquisition technique. However, it is recommended that the compression paddle is as low as possible with some amount of compression force applied, so that the ACR phantom is still firmly compressed and does not move during the image acquisition.
8. Set techniques for the acquisition:

*Table 40: Signal-to-Noise and Contrast-to-Noise Exposure Techniques*

<b>Mode</b>	<b>Focal spot</b>	<b>Exposure Compensation</b>	<b>AEC Sensor</b>	<b>Grid</b>
AEC Auto-Filter	Large	0	2	In

9. Acquire an image using the ACR Phantom Conv view.
10. Record the kVp, mAs, and exposure index for the acquisition.
11. Accept the image in the Procedure screen on the Acquisition Workstation.

### **Select the ROI Creation Method**

You have a choice to use either the Automatic or Manual ROI method after acquiring the ACR Phantom image.

#### **Automatic ROI Creation**

When you use the ACR Phantom view to acquire an image, the system assumes that an ACR Phantom is being imaged and activates the SNR button to the Tools tab window on the Procedure screen. The system automatically acquires and computes the SNR and CNR values.

# Quality Control Manual for Selenia Dimensions and 3Dimensions Systems

## Chapter 4: Quality Control Activities for the Radiologic Technologist

1. Select the **SNR** button () The system places two ROI boxes on the image and displays SNR, CNR and corresponding information used for the calculations (see following figure).



### Note

If the ROIs placed automatically by the system do not match the relative positions as displayed in the previous figure, you can manually adjust the location of the ROIs. The SNR and CNR results are recalculated automatically.

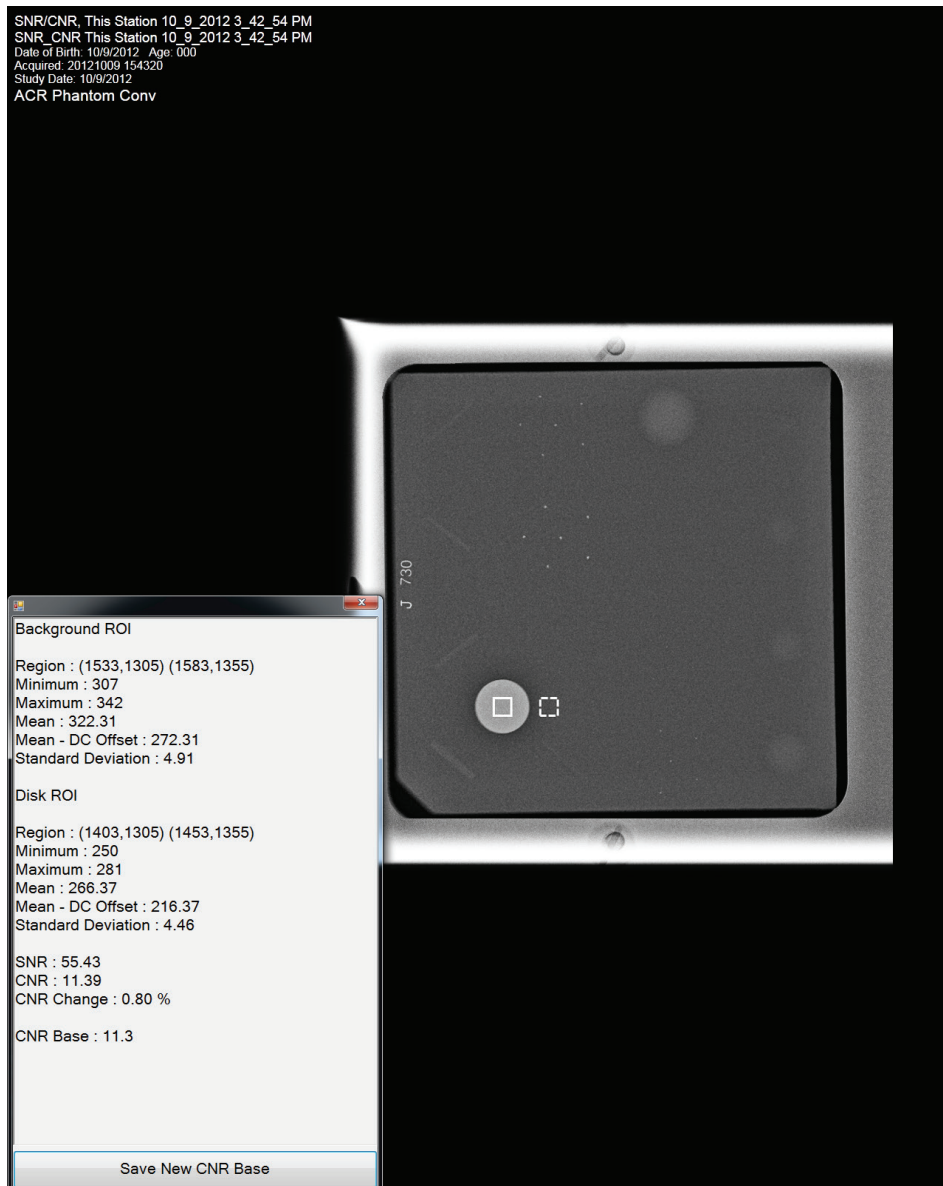

Figure 16: SNR Results Dialog Box



### Manual ROI Creation

1. Select the **ROI tab** on the Procedure screen.
2. Select **Draw** or **64** and use the trackball to draw an ROI on the preview image completely inside the acrylic disk. The ROI window displays the available ROI information (see the following figure).

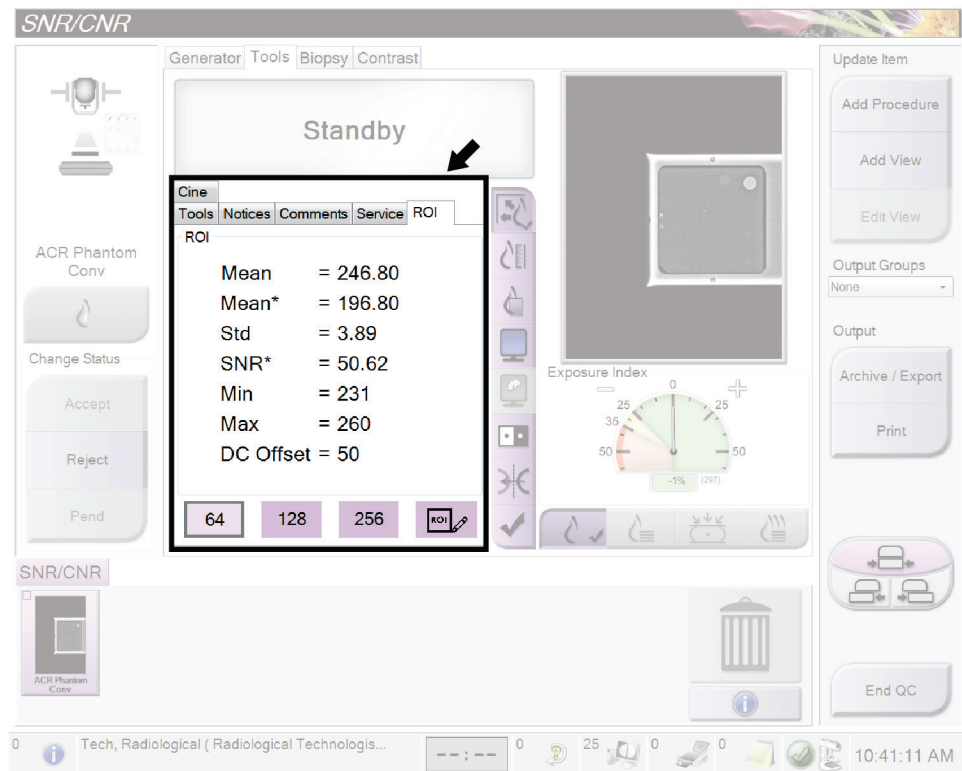

Figure 17: ROI Information Screen

3. Record the mean value (Mean) given in the ROI window.
4. Drag the previously drawn ROI right next to the acrylic disk, towards the chest wall, as shown in the SNR Results Dialog Box figure in the previous Automatic ROI Creation topic.
5. New ROI Statistics appear in the ROI window.
6. Record the mean value (Mean), the SNR, and the standard deviation (Std).

### Update the Quality Control Data on the Acquisition Workstation

- If you used a previously acquired ACR Phantom Image for your test:
  - a. From the Select Patient screen, select **Admin > Quality Control > Technologist tab > SNR/CNR**.
  - b. Select the **Mark Completed** button to label the status of this procedure as finished. Select the **Yes** button to mark the Quality Control procedure as completed.
- If you acquired a new ACR Phantom Image for your test, select the **End QC** button to mark the Quality Control procedure as completed when you are done with Data Analysis and Interpretation.

#### 4.6.5 Record Forms

Use the "Signal-To-Noise Ratio (SNR) and Contrast-To-Noise Ratio (CNR)" form in Appendix B to record the results.

#### 4.6.6 Data Analysis and Interpretation

##### Automated Method

With the automated SNR and CNR function, the SNR and CNR are calculated automatically for an appropriately acquired phantom view. The values of SNR and CNR, as well as the ROIs used for the measurement are displayed. The user should check if the ROIs selected by the program are in the appropriate locations. If they are well positioned, record the SNR and CNR values. If the location of one ROI or both ROIs need to be adjusted, move the ROI(s) to the appropriate location and the SNR and CNR values will be automatically updated based on the new ROI location.



##### Note

The calculation of the SNR value displayed by the automated method already accounts for the DC offset.

---

##### Manual Method (for reference use only)



##### Note

The SNR must be computed using the mean and standard deviation values obtained from the ROI next to the acrylic disk.

A CNR Calculation worksheet is provided in Appendix B to perform manual calculations of the CNR and Diff CNR.

---

1. Compute the SNR of the detector according to

$$SNR = \frac{mean_{background} - DC_{offset}}{std_{background}}$$

where  $mean_{background}$  and  $std_{background}$  are the mean and standard deviation obtained from the ROI Statistics dialog for the ROI next to the acrylic disk and  $DC_{offset}$  is a DC offset added to the detector signal and is equal to 50.

2. Compute the CNR of the detector according to

$$CNR = \frac{mean_{background} - mean_{disk}}{std_{background}}$$

where  $mean_{disk}$  is the mean value obtained from the ROI Statistics dialog for the ROI on the acrylic disk.

3. Compute the deviation from the original CNR measurement according to

$$Diff = \frac{CNR_{measured} - CNR_{base}}{CNR_{base}} \times 100$$

where  $CNR_{base}$  is the CNR base value established by the medical physicist during acceptance testing of the digital detector and is recorded in the *Signal-To-Noise Ratio (SNR) and Contrast-To-Noise Ratio (CNR) Control Chart* included with this manual;  $CNR_{measured}$  is the new CNR computed in step 2.

#### 4.6.7 Recommended Performance Criteria and Corrective Action

The measured SNR must be equal to or greater than 40. If it is less than 40, repeat the test.

The computed CNR must be within  $\pm 15\%$  of the value determined by the medical physicist during the equipment evaluation when the image receptor was installed or after a major upgrade.

If these criteria are not met, a qualified service engineer must correct the problem before using the system for clinical imaging.



#### Note

The CNR baseline may need to be evaluated and a new value may need to be established under the following conditions:

- detector replacement
  - detector modification (i.e. power supply replacement, readout sequence replacement, etc.)
  - AEC dose adjustment
  - ACR phantom replacement or alteration (i.e. permanent repositioning of the acrylic disk)
  - any other reason the medical physicist feels that may affect the CNR calculation
-

### 4.7 Compression Thickness Indicator

#### 4.7.1 Objective

To assure that the indicated compression thickness is within tolerance.

#### 4.7.2 Frequency

Biweekly (every two weeks)

#### 4.7.3 Suggested Equipment

- ACR Mammographic Accreditation Phantom (for example, RMI 156 by Radiation Measurement, Inc.; 18-220 by Nuclear Associates)
- 7.5 cm QC or spot contact compression paddle

#### 4.7.4 Test Procedure



---

##### Note

The first time you use the ACR phantom, measure the phantom thickness and record this measurement as the **Base** on the *Compression Thickness Indicator* chart in Appendix B.

---

1. Center the ACR phantom laterally on the image receptor and position it so the chestwall edge of the phantom is aligned with the chest wall side of the image receptor.
2. Install the 7.5 cm QC or spot contact compression paddle in the compression device.
3. Apply compression force of approximately 30 pounds (~133N) to the ACR phantom.
4. Record the thickness indicated on the compression device on the record form.
5. Select **Admin>Quality Control>Technologist tab>Compression Thickness Indicator** procedure on the Acquisition Workstation.
6. Select the **Mark Completed** button to mark the status of this procedure as finished. Select **Yes** to mark the Quality Control procedure as completed.

#### 4.7.5 Records Forms

Use "Compression Thickness Indicator" form in Appendix B to track the results.

#### 4.7.6 Data Analysis and Interpretation

Subtract the actual thickness of the ACR phantom from the thickness indicated on the compression device and record the result on the record form.

#### **4.7.7 Recommended Performance Criteria and Corrective Action**

The compression thickness indicator must always be accurate to  $\pm 0.5$  cm from the actual thickness.

If the recommended performance criteria are not met, the source of the problem must be identified and corrective action must be taken within thirty days of the test date.

### 4.8 Diagnostic Review Workstation Quality Control

#### 4.8.1 Objective

To assure consistency of the brightness, contrast and image presentation of the radiologist's diagnostic review workstation.



---

**Note**

This diagnostic review workstation Quality Control procedure does not overwrite any Quality Control procedures defined by the manufacturer of the review workstation in use. Instead, this QC procedure serves as a QC protocol for mammography review workstations that do not have a Quality Control procedure established by their manufacturer. Only in the event that the diagnostic review workstation does not have its own QC procedure or form, does this procedure and form in Appendix B need to be followed.

---



---

**Note**

Hologic review workstations come with their own diagnostic review workstation quality control program defined on a separate Quality Control Manual. Please use that QC manual to perform Quality Control on Hologic review workstations.

---

#### 4.8.2 Frequency

Weekly when applicable.

#### 4.8.3 Suggested Equipment (Applies to CRT and some LCD displays)

Integrated photometer or external photometer.

#### 4.8.4 System Application Consideration

1. Select **Admin>Quality Control>Technologist tab>Diagnostic Review Workstation Quality Control** procedure on the Acquisition Workstation.
2. Select the **Mark Completed** button to label the status of this procedure as finished. Select the **Yes** button to mark the Quality Control procedure as completed.

#### 4.8.5 Proposed Test Procedure for Workstations without Defined Quality Control

The following sections should only be considered if the workstation manufacturer does not provide an approved Quality Control procedure with their diagnostic review workstation.

### Suggested Tests

1. Measure the display white level for each CRT or LCD display.
2. Measure the display black level for each CRT display.
3. Measure the DICOM GSDF compliance for each CRT or LCD display.



---

#### Note

The room lighting conditions must be similar to those established during diagnostic image review.

---

### 4.8.6 Record Forms

Use the "Diagnostic Review Workstation Quality Control" form in Appendix B to record the results.

### 4.8.7 Data Analysis and Interpretation

Check that the tests results comply with the recommended performance criteria.

### 4.8.8 Recommended Performance Criteria and Corrective Action

#### White Level Performance

The operating white level must be at:

- 300 cd/m<sup>2</sup> for the Barco MGD521 CRT display
- 400 cd/m<sup>2</sup> for the Barco MGD521M CRT display
- 600 cd/m<sup>2</sup> for the Barco Coronis MFGD 5621 HD Mammo LCD display
- 600 cd/m<sup>2</sup> for the Barco Coronis MDMG 5121 Mammo LCD display
- 1000 cd/m<sup>2</sup> for the Barco MDMG 5221 Tomo LCD display
- 1000 cd/m<sup>2</sup> for the Barco MDMG 12133 Coronis Uniti display
- 500 cd/m<sup>2</sup> for the Barco Coronis MFGD 5421 LCD display
- 500 cd/m<sup>2</sup> for the Barco Nio MDNG-6121 display
- 500 cd/m<sup>2</sup> for the Barco Nio MDNG-5121 display

The tolerance level for white level performance is  $\pm 6\%$ .

If the measured white level is outside the tolerance level, the display must be calibrated and the performance criteria must be met prior to performing mammographic image interpretation on the diagnostic review workstation with the affected display.



#### Note

If the displays used by the diagnostic review workstation are not listed in this section, the display manufacturer specifications for calibrated white level apply.

---

### **Black Level Performance (Applies to CRT displays only)**

The operating black level must be less than or equal to 1.0 cd/m<sup>2</sup> for the Barco MGD521 and MGD521M displays.

If the measured black level is outside the tolerance level, the display must be calibrated and the performance criteria must be met prior to performing mammographic image interpretation on the diagnostic review workstation with the affected display.

### **Quality Level Performance, Compliance Test (DICOM GSDF Compliance Check)**

The operating DICOM GSDF compliance of each display must not exceed a total difference of 10%.

If the measured quality level is outside the tolerance level, the display must be calibrated and the performance criteria must be met prior to performing mammographic image interpretation on the diagnostic review workstation with the affected display.



#### **Note**

If the displays used by the diagnostic review workstation are not listed in this section, the display manufacturer specifications for calibrated black level applies.

---

### **Uniformity Performance (Applies to CRT displays only)**

The brightness deviation from the brightness of the center of the display for the Barco MGD521 and MGD521M displays must not exceed 15%.

If the measured non-uniformities are outside the tolerance level, the display uniformity must be calibrated and the performance criteria must be met prior to performing mammographic image interpretation on the diagnostic review workstation with the affected display.



#### **Note**

If the displays used by the diagnostic review workstation are not listed in this section, the display manufacturer specifications for uniformity performance applies.

---



#### **Note**

A qualified service engineer may have to resolve any issues if tolerance levels cannot be achieved for any of the displays of the diagnostic review workstation.

---



#### **Note**

Image acquisition can continue while issues with the diagnostic review workstation are being addressed. Another approved diagnostic device (i.e. DICOM printer, second diagnostic review workstation) must be used for mammographic image interpretation.

---



## 4.9 Viewboxes and Viewing Conditions

### 4.9.1 Objective

To assure that the viewboxes and viewing conditions are optimized and their performance stays constant over time.

### 4.9.2 Frequency

Weekly

### 4.9.3 Suggested Equipment

- Window cleaner
- Soft towels

### 4.9.4 Test Procedure

1. Clean viewbox surfaces using cleaner recommended by viewbox manufacturer and soft paper or cotton towels.
2. Ensure that all marks have been removed.
3. Visually inspect the viewboxes for uniformity of luminance.
4. Ensure that all viewbox masking equipment is functioning properly.
5. Visually check that sources of bright light are not being reflected from the viewbox surface.
6. Select **Admin>Quality Control>Technologist tab>Viewboxes and Viewing Conditions** procedure on the Acquisition Workstation.
7. Select the **Mark Completed** button to label the status of this procedure as finished. Select **Yes** to mark the Quality Control procedure as completed.

### 4.9.5 Record Forms

Use the "Viewboxes and Viewing Conditions" form in Appendix B to record the results.

### 4.9.6 Data Analysis and Interpretation

None.

### 4.9.7 Recommended Performance Criteria and Corrective Action

Any marks that are not easily removed with window cleaner must be removed with a safe and appropriate cleaner. If viewboxes appear nonuniform, all of the fluorescent lamps must be replaced as soon as possible. If viewbox masks are difficult to use, appropriate service or modifications should be requested.

Failures must be corrected before clinical images are viewed on the viewbox.

### 4.10 Visual Checklist

#### 4.10.1 Objective

To assure that system indicator lights, displays, mechanical locks and detents are working properly and that the system is mechanically stable.

#### 4.10.2 Frequency

Monthly

#### 4.10.3 Suggested Equipment

None

#### 4.10.4 Test Procedure

1. Review all items listed on the visual checklist and indicate their status. Be sure to rotate the C-arm the way you would for patient imaging.
2. Date and initial the checklist where indicated.
3. Select **Admin>Quality Control>Technologist tab>Visual Checklist** procedure on the Acquisition Workstation.
4. Select the **Mark Completed** button to label the status of this procedure as finished. Select **Yes** to mark the Quality Control procedure as completed.

#### 4.10.5 Record Forms

Use the "Visual Checklist" form in Appendix B to record the results.

#### 4.10.6 Data Analysis and Interpretation

None.

#### 4.10.7 Recommended Performance Criteria and Corrective Action

Each item in the Visual Checklist should pass and receive a check mark. Items not passing the visual checklist should be replaced or corrected immediately.

If the recommended performance criteria are not met, the source of the problem must be identified and corrective action must be taken within thirty days of the test date.

## 4.11 Repeat/Reject Analysis

### 4.11.1 Objective

To determine the number and cause of repeated/rejected mammograms.

### 4.11.2 Frequency

Quarterly



---

**Note**

In order for retake rates to be statistically meaningful, a patient volume of at least 250 patients is needed.

---

### 4.11.3 Suggested Equipment

None

### 4.11.4 Test Procedure

1. Select **Admin>Quality Control>Technologist tab>Reject Analysis** procedure on the Acquisition Workstation.
2. Select the **Start** button.
3. Select the **Last Quarter**, or **Last 30 days**, or set the starting and the ending date.
4. Select the **Operators**.
5. Select the **Go** button to run and display the report.
6. If you would like to save the report to a file, select the **Save HTML** or **Save CSV** button. If you would like to print the file, select **Print**.
7. Select the **Back** button or run another report by repeating Step 3 through Step 6.
8. Select the **Back** button. Select **Yes** to mark the Quality Control procedure as completed.
9. Repeat step 1 through step 8 for the **Repeat Analysis** procedure.

### 4.11.5 Record Forms

Use the *Mammography Repeat/Reject Analysis* forms incorporated into the Acquisition Workstation Repeat/Reject Analysis software or the corresponding "Repeat/Reject Analysis" section of the Monthly, Quarterly, and Semi-Annual form in Appendix B to keep track of when this test was performed.

### 4.11.6 Data Analysis and Interpretation

The data presented in the *Mammography Repeat/Reject Analysis* form provide the repeat/reject statistics.

**4.11.7 Recommended Performance Criteria and Corrective Action**

If the total rate changes from that previously determined by more than 2.0%, the reason(s) for the change must be determined, and corrective action carried out if necessary.

If the recommended performance criteria are not met, the source of the problem must be identified and corrective action must be taken within thirty days of the test date.

## 4.12 Compression

### 4.12.1 Objective

To assure that the mammography system can provide adequate compression in manual and power assisted mode and that compression is controlled.

### 4.12.2 Frequency

Semiannually, or whenever increased or reduced compression is suspected

### 4.12.3 Suggested Equipment

- Bathroom scale
- Towels
- 18 x 24 cm flat compression paddle or 24 x 29 cm flat compression paddle

### 4.12.4 Test Procedure

1. Select **Admin>System Defaults>Comp Mode** on the Acquisition Workstation. Change to **Full**.
2. Place a towel on the image receptor platform to protect the image receptor platform.
3. Place the bathroom scale on the towel with the dial or read-out positioned for easy reading. Locate the center of the scale directly under the compression device.
4. Place one or more towels on top of the scale to prevent damage to the compression paddle.
5. Using the initial power drive, activate the compression device and allow it to operate until it stops automatically.
6. Read and record the compression force on the form.
7. Release the compression device.
8. Using the initial manual drive, move the compression device downward until it stops.
9. Read and record the compression force on the form.
10. Release the compression device.
11. Select **Admin>System Defaults>Comp Mode** on the Acquisition Workstation. Change to **Dual**.
12. Select **Admin>Quality Control>Technologist tab>Compression Test** procedure on the Acquisition Workstation.
13. Select the **Mark Completed** button to label the status of this procedure as finished. Select **Yes** to mark the Quality Control procedure as completed.

### **4.12.5 Record Forms**

Use the "Compression Test Manual" and "Compression Test Automatic" sections of the Monthly, Quarterly, and Semi-Annual form of Appendix B to record the results.

### **4.12.6 Data Analysis and Interpretation**

None.

### **4.12.7 Recommended Performance Criteria and Corrective Action**

1. A compression force of at least 25 pounds (111 newtons) must be provided.
2. The maximum compression force for the initial power drive must be between 25 pounds (111 newtons) and 45 pounds (200 newtons).

If the recommended performance criteria are not met, the source of the problem must be identified and corrective action must be taken before any further examinations are performed using the component of the mammography system that failed the test.

## Appendix A Quality Control Forms for the Medical Physicist



**Caution:**

If electronic forms or forms other than the forms listed in this appendix are used with the current revision of this manual, it is the responsibility of the user to verify that the alternative forms are equivalent to the forms printed in this manual.

Table 41: Quality Control Tests to Be Performed by the Medical Physicist on All Systems

Quality Control Test	Frequency	Action Criteria	Section Title
Mammographic Unit Assembly Evaluation	Annually	Category C	<a href="#">Mammographic Unit Assembly Evaluation</a> on page 25
Collimation Assessment	Annually	Category C	<a href="#">Collimation Assessment</a> on page 26
Artifact Evaluation	Annually	Category C	<a href="#">Artifact Evaluation</a> on page 37
kVp Accuracy and Reproducibility	Annually	Category C	<a href="#">kVp Accuracy and Reproducibility</a> on page 44
Beam Quality Assessment—HVL Measurement	Annually	Category C	<a href="#">Beam Quality Assessment—Half-Value Layer Measurement</a> on page 46
Evaluation of System Resolution	Annually	Category A	<a href="#">Evaluation of System Resolution</a> on page 49
Automatic Exposure Control (AEC) Function Performance	Annually	Category C	<a href="#">Automatic Exposure Control (AEC) Function Performance</a> on page 52
Dose and AEC Reproducibility	Annually	Category A Category C	<a href="#">Breast Entrance Exposure, AEC Reproducibility, and AGD</a> on page 57
Radiation Output Rate	Annually	Category C	<a href="#">Radiation Output Rate</a> on page 63
Phantom Image Quality Evaluation	Annually	Category A	<a href="#">Phantom Image Quality Evaluation</a> on page 66
Signal-To-Noise and Contrast-To-Noise Measurements	Annually	Category A	<a href="#">Signal-To-Noise and Contrast-To-Noise Measurements</a> on page 69
Diagnostic Review Workstation Quality Control	Annually	Category B	<a href="#">Diagnostic Review Workstation Quality Control</a> on page 76
Detector Ghosting (troubleshooting use only)	—	Category A	<a href="#">Detector Ghosting (Troubleshooting Use Only)</a> on page 79

**This page is intentionally left blank.**



# Quality Control Manual for Selenia Dimensions and 3Dimensions Systems

## Appendix A: Quality Control Forms for the Medical Physicist

### MEDICAL PHYSICIST'S MAMMOGRAPHY QC TEST SUMMARY

Site	<input style="width: 95%;" type="text"/>	Report Date	<input style="width: 95%;" type="text"/>
		Survey Date	<input style="width: 95%;" type="text"/>
X-Ray Unit Manufacturer	<input style="width: 95%;" type="text"/>	Model	<input style="width: 95%;" type="text"/>
Date of Installation	<input style="width: 95%;" type="text"/>	Room ID	<input style="width: 95%;" type="text"/>
Medical Physicist	<input style="width: 95%;" type="text"/>	Signature	<input style="width: 95%;" type="text"/>

	Pass-Fail
<b>1. Mammographic Unit Assembly Evaluation</b>	<input type="text"/>
Autodecompression can be overridden to maintain compression (and status displayed)	<input type="text"/>
Manual emergency compression release can be activated in the event of a power failure	<input type="text"/>
<b>2. Collimation Assessment</b>	<input type="text"/>
Deviation between X-ray field and light field is less than 2% of SID	<input type="text"/>
X-ray field does not extend beyond any side of the IR by more than 2% of SID	<input type="text"/>
<b>3. Artifact Evaluation</b>	<input type="text"/>
Artifacts were not apparent or not significant	<input type="text"/>
<b>4. kVp Accuracy and Reproducibility</b>	<input type="text"/>
Measured average kVp within $\pm 5\%$ of indicated kVp	<input type="text"/>
kVp coefficient of variation $\leq 0.02$	<input type="text"/>
<b>5. Beam Quality Assessment--Half-Value Layer Measurement</b>	<input type="text"/>
Half-value layer is within acceptable lower limit at all kVp values tested	<input type="text"/>
<b>6. Evaluation of System Resolution</b>	<input type="text"/>
Measured performance within acceptable limits	<input type="text"/>
<b>7. Automatic Exposure Control (AEC) Function Performance</b>	<input type="text"/>
Measured performance within acceptable limits	<input type="text"/>
<b>8. Breast Entrance Exposure, AEC Reproducibility and Average Glandular Dose</b>	<input type="text"/>
Average glandular dose for average breast is below 3 mGy (300 mrad)	<input type="text"/>
Average glandular dose to a 4.2-cm-thick breast on your unit is	<input type="text"/>
mrad <input style="width: 50px;" type="text"/> Conventional	<input type="text"/>
mrad <input style="width: 50px;" type="text"/> Tomo View (Tomo Option)	<input type="text"/>
mrad <input style="width: 50px;" type="text"/> Combo View (Tomo Option)	<input type="text"/>
Coefficient of variation for either R or mAs shall not exceed 0.05	<input type="text"/>
<b>9. Radiation Output Rate</b>	<input type="text"/>
Radiation output rate: $\geq 230$ mR/sec	<input style="width: 50px;" type="text"/> <input style="width: 50px;" type="text"/>
<b>10. Phantom Image Quality Evaluation</b>	<input type="text"/>
Phantom image quality scores:	<input type="text"/>
Fibers <input style="width: 50px;" type="text"/>	<input type="text"/>
Specks <input style="width: 50px;" type="text"/>	<input type="text"/>
Masses <input style="width: 50px;" type="text"/>	<input type="text"/>
Phantom image quality scores (Tomosynthesis option):	<input type="text"/>
Fibers <input style="width: 50px;" type="text"/>	<input type="text"/>
Specks <input style="width: 50px;" type="text"/>	<input type="text"/>
Masses <input style="width: 50px;" type="text"/>	<input type="text"/>
<b>11. Signal-To-Noise Ratio and Contrast-To-Noise Ratio Measurement</b>	<input type="text"/>
Signal-To-Noise Ratio should be equal or greater to 40	<input style="width: 50px;" type="text"/>
Contrast-To-Noise Ratio should not vary by more than $\pm 15\%$	<input style="width: 50px;" type="text"/>
SNR <input style="width: 50px;" type="text"/>	<input type="text"/>
CNR <input style="width: 50px;" type="text"/>	<input type="text"/>
<b>12. Diagnostic review workstation</b>	<input type="text"/>
White level performance	<input type="text"/>
Black level performance (CRT Displays only)	<input type="text"/>
Quality level performance (GSDF compliance)	<input type="text"/>
Uniformity performance (CRT Displays only)	<input type="text"/>



**This page is intentionally left blank.**

**MEDICAL PHYSICIST'S MAMMOGRAPHY QC TEST SUMMARY**  
*(continued)*

**Evaluation of Site's Technologist QC Program**



1. DICOM Printer Quality Control
2. Detector Flat Field Calibration
3. Geometry Calibration (Tomosynthesis Option)
4. Artifact Evaluation
5. Phantom Image Quality Evaluation
6. Signal-To-Noise and Contrast-To-Noise Measurements
7. Compression Thickness Indicator
8. Diagnostic Review Workstation QC
9. Viewbox and Viewing Conditions
10. Visual Checklist
11. Repeat/Reject Analysis
12. Compression

**Pass-Fail**

**Medical Physicist's Recommendations for Quality Improvement**

**This page is intentionally left blank.**

# Quality Control Manual for Selenia Dimensions and 3Dimensions Systems

## Appendix A: Quality Control Forms for the Medical Physicist

### Mammography Equipment Evaluation (MEE)

MQSA Requirements listed from FDA Rule Sec. 900.12(b) – This form applies for MEE only

Feature	Requirements	Rule
Motion of tube-image receptor assembly	The assembly shall be capable of being fixed in any position where it is designed to operate. Once fixed in any such position, it shall not undergo unintended motion.	3(i)
	The mechanism shall not fail in the event of power interruption.	3(ii)
Image receptor sizes	Systems used for magnification procedures shall be capable of operation with the grid removed from between the source and image receptor.	4(iii)
Light fields	For any mammography system with a light beam that passes through the x-ray beam-limiting device, the light shall provide an average illumination of not less than 160 lux (15 foot candles) at 100 cm or the maximum source-image receptor distance (SID), whichever is less.	5
Magnification	Systems used to perform noninterventional problem solving procedures shall have radiographic magnification capability available for use by the operator.	6(i)
	Systems used for magnification procedures shall provide, at a minimum, at least one magnification value within the range of 1.4 to 2.0.	6(ii)
Focal spot selection	When more than one focal spot is provided, the system shall indicate, prior to exposure, which focal spot is selected.	7(i)
	When more than one target material is provided, the system shall indicate, prior to exposure, the preselected target material.	7(ii)
	When the target material and/or focal spot is selected by a system algorithm that is based on the exposure or on a test exposure, the system shall display, after the exposure, the target material and/or focal spot actually used during the exposure.	7(iii)
Application of compression	System shall provide an initial power-driven compression activated by hands-free controls operable from both sides of the patient	8(i)A
	System shall provide fine adjustment compression controls operable from both sides of the patient.	8(i)B
Compression paddle	System shall be equipped with different sized compression paddles that match the sizes of all full-field image receptors provided for the system. Compression paddles for special purposes, including those smaller than the full size of the image receptor (for "spot compression") may be provided.	8(ii)A
	The compression paddle shall be flat and parallel to the breast support table and shall not deflect from parallel by more than 1.0 cm at any point on the surface of the compression paddle when compression is applied.	8(ii)B
	Equipment intended by the manufacturer's design to not be flat and parallel to the breast support table during compression shall meet the manufacturer's design specifications and maintenance requirements.	8(ii)C
	The chest wall edge of the compression paddle shall be straight and parallel to the edge of the image receptor.	8(ii)D
	The chest wall edge may be bent upward to allow for patient comfort but shall not appear on the image.	8(ii)E
Technique factor selection and display	Manual selection of milliamperere seconds (mAs) or at least one of its component parts (milliamperere (mA) and/or time) shall be available.	9(i)
	The technique factors (peak tube potential in kilovolt (kV) and either tube current in mA and exposure time in seconds or the product of tube current and exposure time in mAs) to be used during an exposure shall be indicated before the exposure begins, except when automatic exposure controls (AEC) are used, in which case the technique factors that are set prior to the exposure shall be indicated.	9(ii)
	Following AEC mode use, the system shall indicate the actual kilovoltage peak (kVp) and mAs used during the exposure. The mAs may be displayed as mA and time.	9(iii)
Lighting	The facility shall make special lights for film illumination (i.e., hot-lights), capable of producing light levels greater than that provided by the view box, available to the interpreting physicians.	14
Film masking devices	Facilities shall ensure that film masking devices that can limit the illuminated area to a region equal to or smaller than the exposed portion of the film are available to all interpreting physicians interpreting for the facility.	15

**This page is intentionally left blank.**

# Quality Control Manual for Selenia Dimensions and 3Dimensions Systems

Appendix A: Quality Control Forms for the Medical Physicist

## 1. Mammography Unit Assembly Evaluation

Site:

Technologist(s):

Room ID:	Date:
X-ray unit manufacturer:	Model:
Diagnostic review workstation:	Model:
DICOM printer manufacturer:	Model:

	Pass/Fail/NA
Free-standing unit is mechanically stable	<input style="width: 100%; height: 20px;" type="text"/>
All moving parts move smoothly, without obstructions to motion	<input style="width: 100%; height: 20px;" type="text"/>
All locks and detents work properly	<input style="width: 100%; height: 20px;" type="text"/>
Image receptor holder assembly is free from vibrations	<input style="width: 100%; height: 20px;" type="text"/>
Compressed breast thickness scale accurate to $\pm 0.5$ cm, reproducible to $\pm 0.2$ cm	<input style="width: 100%; height: 20px;" type="text"/>
Patient or operator is not exposed to sharp or rough edges, or other hazards	<input style="width: 100%; height: 20px;" type="text"/>
Operator technique control charts are posted	<input style="width: 100%; height: 20px;" type="text"/>
Operator protected during exposure by adequate radiation shielding	<input style="width: 100%; height: 20px;" type="text"/>
All indicator lights are working properly	<input style="width: 100%; height: 20px;" type="text"/>
Autodecompression can be overridden to maintain compression (and status displayed)	<input style="width: 100%; height: 20px;" type="text"/>
Manual energy compression release can be activated in the event of a power failure	<input style="width: 100%; height: 20px;" type="text"/>

Comments:

**This page is intentionally left blank.**



## 2a. Collimation Assessment

### *X-Ray Field to Light Field Coincidence*

#### Geometric Factors

Source to image receptor distance (SID): 70.0 cm

Source to breast support platform distance: 67.5 cm

$$f_{(\text{geom})} = 70.0 / (67.5 - \text{height})$$

height: distance between top of breast support platform and bottom of attenuator

	Collimation (cm)	24x29
<b>Left Edge</b>	Physical Measurement*	
	$f_{(\text{geom})}$ Corrected ( <b>L_dev</b> )**	
<b>Right Edge</b>	Physical Measurement	
	$f_{(\text{geom})}$ Corrected ( <b>R_dev</b> )	
	<b> L_dev  +  R_dev ***</b>	
	<b>( L_dev  +  R_dev ) as % of SID</b>	
<b>Anterior Edge</b>	Physical Measurement	
	$f_{(\text{geom})}$ Corrected ( <b>A_dev</b> )	
<b>Chest Edge</b>	Physical Measurement	
	$f_{(\text{geom})}$ Corrected ( <b>C_dev</b> )	
	<b> A_dev  +  C_dev </b>	
	<b>( A_dev  +  C_dev ) as % of SID</b>	

**ACTION LIMIT: If sum of left plus right edge deviations or anterior plus chest edge deviations exceed 2% of SID, seek service adjustment.**

\*Physical Measurement: the measured difference between x-ray and light field on the projected plane of the light field

\*\* $f_{(\text{geom})}$  Corrected = (Physical Measurement) \*  $f_{(\text{geom})}$

\*\*\*Add the geometrically corrected deviations from both sides disregarding the signs

**This page is intentionally left blank.**

## 2b. Collimation Assessment

### X-Ray Field to Image Receptor Alignment

#### Geometric Factors

Source to image receptor distance (SID): 70.0 cm

Source to breast support platform distance: 67.5 cm

$$f_{(ERMF)} = (67.5 - \text{height}) * ERMF / 70.0$$

$$f_{(geom)} = 70.0 / (67.5 - \text{height})$$

*height: distance between top of breast support platform and bottom of attenuator*

Collimation (cm)		24x29	18x24 (L)	18x24 (C)	18x24 (R)	18x29 (C)*
<b>Left Edge</b>	Preview Measurement**					
	$f_{(ERMF)}$ Corrected***					
	Attenuator Difference****					
	Total Deviation*****					
	<b>% of SID (retain sign)*****</b>					
<b>Right Edge</b>	Preview Measurement					
	$f_{(ERMF)}$ Corrected					
	Attenuator Difference					
	Total Deviation					
	<b>% of SID (retain sign)</b>					
<b>Anterior Edge</b>	Preview Measurement					
	$f_{(ERMF)}$ Corrected					
	Attenuator Difference					
	Total Deviation					
	<b>% of SID (retain sign)</b>					
<b>Chest Edge</b>	Preview Measurement					
	$f_{(ERMF)}$ Corrected					
	Attenuator Difference					
	Total Deviation					
	<b>% of SID (retain sign)</b>					

**ACTION LIMIT:** If x-ray field exceeds image receptor at any side by more than 2% of SID or if x-ray field falls within image receptor on the chest wall side, seek service adjustment.

\*Tomosynthesis option

\*\*Preview Measurement: measurement on preview display from image edge to inner edge of attenuator

\*\*\* $f_{(ERMF)}$  Corrected = (Preview Measurement) \*  $f_{(ERMF)}$

\*\*\*\*Attenuator Difference = (Physical width of attenuator) - ( $f_{(ERMF)}$  Corrected)

\*\*\*\*\*Total Deviation: (Attenuator Difference) \*  $f_{(geom)}$  + (L\_dev, or R\_dev, or A\_dev, or C\_dev from Form 2a, depending on the side)

\*\*\*\*\*% of SID (retain sign): Total Deviation expressed as a percentage of the SID

**This page is intentionally left blank.**

## 2c. Collimation Assessment

### *Flat Compression Paddle to Image Receptor Alignment*

#### Geometric Factors

Source to image receptor distance (SID): 70.0 cm

Source to breast support platform distance: 67.5 cm

$$f_{(ERMF)} = (67.5 - \text{height}) * ERMF / 70.0$$

$$f_{(geom)} = 70.0 / (67.5 - \text{height})$$

height: distance between top of breast support platform and bottom of attenuator, i.e. 4.0 cm in this case

Compression Paddle	Visible edge?	24x29		18x24		Small Breast*	
		YES	NO	YES	NO	YES	NO
Chest Edge							
Preview Measurement**							
$f_{(ERMF)}$ Corrected***							
Attenuator Difference****							
Total Deviation*****							
% of SID (retain sign)							

**ACTION LIMIT:** If the chest-wall edge of the compression paddle is within the image receptor or projects beyond the chest-wall edge of the image receptor by more than 1% of the SID, seek service correction.

\*When available, only

\*\*Preview Measurement: measurement on preview display from image edge to inner edge of attenuator

\*\*\* $f_{(ERMF)}$  Corrected = (Preview Measurement) \*  $f_{(ERMF)}$

\*\*\*\*Attenuator Difference = (Physical width of attenuator) - ( $f_{(ERMF)}$  Corrected)

\*\*\*\*\*Total Deviation: (Attenuator Difference) \*  $f_{(geom)}$

\*\*\*\*\*% of SID (retain sign): Total Deviation expressed as a percentage of the SID

**This page is intentionally left blank.**

## 2d. Collimation Assessment

### *SmartCurve Compression Paddle to Image Receptor Alignment*

#### Geometric Factors

Source to image receptor distance (SID): 70.0 cm

Source to breast support platform distance: 67.5 cm

$$f_{(ERMF)} = (67.5 - \text{height}) * ERMF / 70.0$$

$$f_{(geom)} = 70.0 / (67.5 - \text{height})$$

height: distance between top of breast support platform and bottom of attenuator, i.e. 4.0 cm in this case

Compression Paddle		18x24 SmartCurve		24x29 SmartCurve	
<b>Chest Edge</b>	Visible edge?	YES	NO	YES	NO
	Ruler Measurement (corresponding flat)				
	Ruler Measurement (curved)				
	Ruler Measurement Difference**				
	Attenuator Difference from flat paddle alignment test with coin****				
	Attenuator Difference + Ruler Measurement Difference****				
	Total Deviation*****				
	<b>% of SID (retain sign)</b>				

**ACTION LIMIT: If the chest-wall edge of the compression paddle is within the image receptor or projects beyond the chest-wall edge of the image receptor by more than 1% of the SID, seek service correction.**

\*When available, only

\*\*Ruler Measurement = Ruler Measurement (curved) - Ruler Measurement (corresponding flat)

\*\*\*Attenuator Difference = (Physical width of attenuator) - (f(ERMF) Corrected)

(from coin method recommended for flat compression paddle to image receptor alignment testing)

\*\*\*\*Sum of Attenuator Difference and Ruler Measurement Difference

\*\*\*\*\*Total Deviation: (Sum of Attenuator Difference and Ruler Measurement Difference) \*  $f_{(geom)}$

\*\*\*\*\*% of SID (retain sign): Total Deviation expressed as a percentage of the SID





**This page is intentionally left blank.**



### 3. Artifact Evaluation

Type of attenuator:	
Attenuator thickness:	
kVp setting:	
DICOM Printer	

**Acrylic Phantom**

<b>Image size (cm)</b>	24 x 29	24 x 29	24 x 29 	24 x 29** 	18 x 24 	18 x 24 
<b>Target / Filter</b>	W/Rh	W/Ag	W/Al	W/Cu	W/Rh	W/Ag
<b>Focal spot</b>	Large	Large	Large	Large	Small	Small
<b>Acceptable?</b>						
<b>Comments</b>						

**DICOM Printer:** \_\_\_\_\_

<b>Image Size</b>	18 x 24	24 x 29***
<b>Acceptable?</b>		
<b>Comments</b>		

**ACTION LIMIT:**                    **If significant artifacts are visible, contact a qualified service engineer for either the Selenia Dimensions System or the DICOM printer, or both, as required.**

- \* Tomosynthesis option
- \*\* CE2D Option
- \*\*\*If available on the printer

**Remarks**

Date	Action

**This page is intentionally left blank.**

### 4. kVp Accuracy and Reproducibility

kVp meter used:

Setting:

Nominal kVp setting						
Focal spot						
mAs setting						
<b>Filter</b>						
Measured kVp values:						
	1					
	2					
	3					
	4					
Mean kVp						
Standard deviation (SD)						
Additional kVp measurements (if needed):						
	5					
	6					
	7					
	8					
	9					
	10					
Recalculated:						
Mean kVp						
Standard deviation (SD)						
Mean kVp - Nominal kVp						
0.05 x Nominal kVp						
<b>% Error</b>						
<b>Coefficient of variation (SD/Mean kVp)</b>						

**ACTION LIMIT:**

**If the mean kVp differs from the nominal by more than  $\pm 5\%$  of the nominal kVp, or if the coefficient of variation exceeds 0.02, then seek service correction.**

**This page is intentionally left blank.**

### 5. Beam Quality Assessment--HVL Measurement

Dosimetry system used:

kVp setting					
mAs setting					
Target material	W	W	W	W	
Filter	Rh	Ag	Al*	Cu**	
Paddle in place	Yes	Yes	Yes	Yes	
<b>Exposure measurements (mR):</b>					
No aluminum filtration, E <sub>0a</sub>					
0.2 mm of added aluminum, E <sub>0.2</sub>					
0.3 mm of added aluminum, E <sub>0.3</sub>					
0.4 mm of added aluminum, E <sub>0.4</sub>					
0.5 mm of added aluminum, E <sub>0.5</sub>					
0.6 mm of added aluminum, E <sub>0.6</sub>					
No aluminum filtration, E <sub>0b</sub>					
<b>Calculations</b>					
E <sub>0</sub> = (E <sub>0a</sub> + E <sub>0b</sub> ) / 2					
E <sub>1/2</sub> = E <sub>0</sub> / 2					
Exposure greater than E <sub>1/2</sub> : E <sub>a</sub>					
Al thickness at E <sub>a</sub> : t <sub>a</sub>					
Exposure less than E <sub>1/2</sub> : E <sub>b</sub>					
Al thickness at E <sub>b</sub> : t <sub>b</sub>					
<b>Calculated HVL (mm Al)</b>					
<b>Minimum allowed</b>					

\*Tomosynthesis option

\*\*CE2D option

$$HVL = \frac{t_b \ln[2E_a/E_0] - t_a \ln[2E_b/E_0]}{\ln[E_a/E_b]}$$

**ACTION LIMIT:**

Seek service correction if measured HVL < (kVp/100) + 0.03 (in mm Al)

**This page is intentionally left blank.**

## 6. System Limiting Spatial Resolution

X-ray Tube Manufacturer:

Model #

Nominal focal spot size (mm)	
kVp setting	
mAs setting	
<b>Limiting resolution in cycles per mm</b>	

**ACTION LIMIT:**

If limiting resolution reading with the bars at 45° relative to the anode-cathode axis is not greater than 7 cycles/mm, contact a qualified service engineer.



### Tomosynthesis Option

Nominal focal spot size (mm)	
kVp setting	
mAs setting	
<b>Limiting resolution in cycles per mm</b>	

**ACTION LIMIT:**

If limiting resolution reading with the bars at 45° relative to the anode-cathode axis is not greater than 3 cycles/mm, contact a qualified service engineer.

**This page is intentionally left blank.**



### 7a. Automatic Exposure Control (AEC) Function Performance

AEC Position:

Exposure Compensation Step:

**AEC Function Performance at Different Phantom Thickness**

**D<sub>x</sub>**

Contact Imaging, LFS with Grid								
Phantom Thickness	AEC Mode	kVp	mAs	Filter	Exp Comp Step	Exposure Index	CNR Correction Factor*	Corrected Pixel Value**
2 cm								
4 cm								
6 cm								
8 cm								
Magnification Imaging, SFS without Grid								
4 cm								
Corrected Mean Pixel Value		Corrected Pixel Value Range		Allowed Corrected Pixel Value				
		to		to				

\*CNR Correction Factors are listed in Appendix D.

\*\* Corrected Pixel Value = (Exposure Index - DC offset (50)) / CNR Correction Factor

**Action Limit:** If the corrected pixel value of each individual image corresponding to a breast thickness between 2 and 8 cm at any operating mode varies more than 10% of the mean pixel value computed for all tested breast thicknesses and operating modes, seek service.

**Exposure Compensation AEC Performance**

Mean Pixel Value at Step 0:

Contact Imaging, LFS with Grid							
Phantom Thickness	AEC Mode	Exp Comp	Pixel Value*	Ratio **	Allowed Ratio **		
4 cm		-3			0.56	to	0.66
4 cm		-2			0.66	to	0.78
4 cm		-1			0.78	to	0.92
4 cm		0					
4 cm		0					
4 cm		0					
4 cm		+1			1.06	to	1.24
4 cm		+2			1.22	to	1.43
4 cm		+3			1.40	to	1.64
4 cm		+4			1.61	to	1.89

\*Pixel Value = Exposure Index - DC offset (50)

\*\* Pixel value at given step divided by mean pixel value at step 0

**Action Limit:** If the pixel value at each exposure compensation step results in a ratio outside the allowed range, seek service.

**This page is intentionally left blank.**



### 7b. Automatic Exposure Control (AEC) Function Performance (Tomosynthesis Option)

AEC Position:

Exposure Compensation Step:

**AEC Function Performance at Different Phantom Thickness**

Contact Imaging, LFS without Grid								
Phantom Thickness	AEC Mode	kVp	mAs	Filter	Exp Comp Step	Exposure Index	CNR Correction Factor*	Corrected Pixel Value**
2 cm								
4 cm								
6 cm								
8 cm								
<b>Corrected Mean Pixel Value</b>		<b>Corrected Pixel Value Range</b>		<b>Allowed Corrected Pixel Value</b>				
		to		to				

\*CNR Correction Factors are listed in Appendix D.

\*\* Corrected Pixel Value = (Exposure Index - DC offset (50)) / CNR Correction Factor

**Action Limit:** If the corrected pixel value of each individual image corresponding to a breast thickness between 2 and 8 cm at any operating mode varies more than 10% of the mean pixel value computed for all tested breast thicknesses and operating modes, seek service.

**This page is intentionally left blank.**

**Quality Control Manual for Selenia Dimensions and 3Dimensions Systems**

Appendix A: Quality Control Forms for the Medical Physicist

**8a. Breast Entrance Exposure, AEC Reproducibility, and Average Glandular Dose**

Source to image receptor distance (SID):	70 cm
Source to breast support platform distance:	67.5 cm
Source to radiation detector distance:	
Dosimeter used:	
Energy correction factor:	

Breast thickness (cm)	4.2	4.2	4.2	4.2
Phantom Serial Number				
kVp setting				
Target material	W	W	W	W
Filter				
AEC Mode				
AEC Position				
Exp. Compensation Step				
Measured HVL (mm Al)				

**Breast Entrance Exposure**

	R	mAs	R	mAs	R	mAs	R	mAs
Exposure #1								
Exposure #2								
Exposure #3								
Exposure #4								
Mean values								
Standard deviations (SD)								
Coefficient of variation (CV)								

**ACTION LIMIT:** If coefficient of variation for either R or mAs exceeds 0.05, seek service.

**Average Glandular Dose:**

Inv Sq corrected skin exp				
Dose conversion factor from Appendix C (mrad/R)				
Computed average glandular dose (mrad)				

**ACTION LIMIT:** If average glandular dose exceeds 300 mrad (3 mGy) for 4.2 cm effective breast thickness, seek service or technique adjustment.

*Corrective action must be taken before further examinations are performed if the test results fail MQSA regulations.*

**This page is intentionally left blank.**



**8b. Breast Entrance Exposure, AEC Reproducibility, and Average Glandular Dose  
Using a Tomosynthesis Only Acquisition  
(Tomosynthesis Option)**

Source to image receptor distance (SID):	70 cm
Source to breast support platform distance:	67.5 cm
Source to radiation detector distance:	
Dosimeter used:	
Energy correction factor:	

Breast thickness (cm)	4.2	4.2	4.2	4.2
Phantom Serial Number				
kVp setting				
Target material	W	W	W	W
Filter				
AEC Mode				
AEC Position				
Exp. Compensation Step				
Measured HVL (mm Al)				

**Breast Entrance Exposure**

	R	mAs	R	mAs	R	mAs	R	mAs
Exposure #1								
Exposure #2								
Exposure #3								
Exposure #4								
Mean values								
Standard deviations (SD)								
Coefficient of variation (CV)								

**ACTION LIMIT:** If coefficient of variation for either R or mAs exceeds 0.05, seek service.

**Average Glandular Dose:**

Inv Sq corrected skin exp				
Dose conversion factor from Appendix C (mrad/R)				
Computed average glandular dose (mrad)				

**ACTION LIMIT:** If average glandular dose exceeds 300 mrad (3 mGy) for 4.2 cm effective breast thickness, seek service or technique adjustment.  
*Corrective action must be taken before further examinations are performed if the test results fail MQSA regulations.*

**This page is intentionally left blank.**





**8c. Breast Entrance Exposure, AEC Reproducibility, and Average Glandular Dose  
Using a Combo Acquisition  
(Tomosynthesis Option)**

Source to image receptor distance (SID):	70 cm
Source to breast support platform distance:	67.5 cm
Source to radiation detector distance:	
Dosimeter used:	
Energy correction factor:	

Part of Combo Exposure	Conventional	Tomosynthesis	Conventional	Tomosynthesis
Breast thickness (cm)	4.2	4.2	4.2	4.2
Phantom Serial Number				
kVp setting				
Target material	W	W	W	W
Filter				
AEC Mode				
AEC Position				
Exp. Compensation Step				
Measured HVL (mm Al)				

**Average Glandular Dose:**

Part of Combo Exposure	Conventional	Tomosynthesis	Conventional	Tomosynthesis
Measured Exposure (R)				
Reported mAs				
Inv Sq corrected skin exp				
Dose conversion factor from Appendix C (mrad/R)				
Computed average glandular dose (mrad)				
Total average glandular dose* (mrad)				

**ACTION LIMIT:**                      **If average glandular dose exceeds 300 mrad (3 mGy) for 4.2 cm effective breast thickness, seek service or technique adjustment.**  
*Corrective action must be taken before further examinations are performed if the test results fail MQSA regulations.*

\*The total average glandular dose is obtained by adding the conventional and tomosynthesis dose values together.

**This page is intentionally left blank.**

# Quality Control Manual for Selenia Dimensions and 3Dimensions Systems

Appendix A: Quality Control Forms for the Medical Physicist

## 8d. Breast Entrance Exposure, AEC Reproducibility, and Average Glandular (CE2D Option)

Source to image receptor distance (SID):	70 cm
Source to breast support platform distance:	67.5 cm
Source to radiation detector distance:	
Dosimeter used:	
Energy correction factor:	

Breast thickness (cm)	4.2		4.2		4.2		4.2	
Phantom Serial Number								
kVp setting								
Target material	W		W		W		W	
Filter	Rh	Cu	Rh	Cu	Rh	Cu	Rh	Cu
AEC Mode								
AEC Position								
Exp. Compensation Step								
Measured HVL (mm Al)								

### Breast Entrance Exposure

	Total R	Total mAs	Total R	Total mAs	Total R	Total mAs	Total R	Total mAs
Exposure #1								
Exposure #2								
Exposure #3								
Exposure #4								
Mean values								
Standard deviations (SD)								
Coefficient of variation (CV)								

**ACTION LIMIT:** If coefficient of variation for either R or mAs exceeds 0.05, seek service.

### Average Glandular Dose:

	Low E*	High E**	Low E	High E	Low E	High E	Low E	High E
Energy separated skin exp								
Inv Sq corrected								
Dose conversion factor from Appendix C (mrad/R)								
Computed average								
Cumulative average glandular dose (mrad)								

**ACTION LIMIT:** If average glandular dose exceeds 300 mrad (3 mGy) for 4.2 cm effective breast thickness, seek service or technique adjustment.

*Corrective action must be taken before further examinations are performed if the*

\* Low energy skin exposure can be isolated as:  $Low\_E = \text{mean}(Total\_R) * (Low\_E \text{ mAs from preview display}) / \text{mean}(Total\_mAs)$

\*\*High energy skin exposure can be isolated as:  $High\_E = \text{mean}(Total\_R) - Low\_E$

**This page is intentionally left blank.**

### 9. Radiation Output Rate

Source to image receptor distance (SID):	70 cm
Source to breast support platform distance:	67.5 cm
Source to radiation detector distance:	
Dosimeter used:	
Energy correction factor:	

#### Radiation Output Rate

	kVp	Anode	Filter	SID (cm)	Exp (mR)	mAs	Time (sec)	Exp Rate (mR/s)	Air Kerma (mGy/s)
4.5 cm above	28	W	Rh						

$$Dose\ Rate\ (mGy/sec) = Exp\ Rate\ (mR/s) \times 0.00873\ mGy/mR$$

**ACTION LIMIT:** Seek service if output rate is less than 2.0 mGy/s (230 mR/s).

**This page is intentionally left blank.**

### 10a. Phantom Image Quality Evaluation

Phantom used:

	Previous Image	Current Image	Comments
Date			
kVp setting			
mAs setting			
Exposure Compensation Step			
Exposure Index			
Number of fibers seen			
<b>Fibers seen after deduction</b>			
<b>Fiber change</b>			
Number of speck groups seen			
<b>Speck groups after deduction</b>			
<b>Speck group change</b>			
Number of masses seen			
<b>Masses seen after deduction</b>			
<b>Mass change</b>			

**ACTION LIMITS:**

The largest 5 fibers, 4 spec groups and 4 masses must be visible. There may be small fluctuations in scoring of the fibers and masses due to phantom variations. If the fiber score is 4.5 and or the mass score is 3.5, then examine the SNR and high contrast resolution of the system. If both those exceed recommended criteria, then a total score of 4.5 fibers, 4.0 specs and 3.5 masses is acceptable. If the phantom score is lower. seek service.

**This page is intentionally left blank.**





### 10b. Phantom Image Quality Evaluation (Tomosynthesis Option)

Phantom used:

	Previous Image	Current Image	Comments
Date			
kVp setting			
mAs setting			
Exposure Compensation Step			
Exposure Index			
Number of fibers seen			
<b>Fibers seen after deduction</b>			
<b>Fiber change</b>			
Number of speck groups seen			
<b>Speck groups after deduction</b>			
<b>Speck group change</b>			
Number of masses seen			
<b>Masses seen after deduction</b>			
<b>Mass change</b>			

**ACTION LIMITS:**

The largest 4 fibers, 3 spec groups and 3 masses must be visible. If the phantom score is lower, seek service.

**This page is intentionally left blank.**

**11. Signal-To-Noise (SNR) and Contrast-To-Noise (CNR) Measurements**

	Current	Last	Comment
Date			
Phantom Serial Number			
Selected kVp			
Selected mAs			
Exposure Index			
Exposure Compensation Step			
Selected Filter			
Background Mean Value			
Background standard deviation			
<b>Signal-To-Noise Ratio</b>			
Mean value on top of disk			
Standard deviation on top of disk			
<b>Contrast-To-Noise Ratio</b>			
CNR difference			

**ACTION LIMIT:** The SNR should be equal to at least 40 and the CNR should not change by more than  $\pm 15\%$ . Corrective action shall be taken before any further examinations are performed if these limits are not met.

**This page is intentionally left blank.**

## 12. Diagnostic Review Workstation QC

Date: \_\_\_\_\_  
 Serial Number: \_\_\_\_\_  
 Photometer Serial Number: \_\_\_\_\_

CRT Display	Left Display	Right Display	Comments
Display Serial Number			
White Level Performance	cd/m <sup>2</sup>	cd/m <sup>2</sup>	
Black Level Performance	cd/m <sup>2</sup>	cd/m <sup>2</sup>	
Quality Level Performance*	%	%	
Uniformity Performance	%	%	

\*Quality Level (GSD compliance) Performance

**ACTION LIMIT:** The white level shall not be different from the display calibration level by more than 6%. The black level shall not exceed 1 cd/m<sup>2</sup>. The quality level performance shall not exceed 10%. The uniformity performance shall not exceed 15%.

LCD Display	Left Display	Right Display	Comments
Display Serial Number			
White Level Performance	cd/m <sup>2</sup>	cd/m <sup>2</sup>	
Quality Level Performance*	%	%	

\*Quality Level (GSD compliance) Performance

**ACTION LIMIT:** The white level shall not be different from the display calibration level by more than 6%. The quality level performance shall not exceed 10%.

**This page is intentionally left blank.**

### 13. Detector Ghosting Form (Troubleshooting Use Only)

**Test Exposures**

	kVp	mAs	Filter	Exposure Step
Exposure 1				
Exposure 2				

Region 1	Region 2	Region 3	Ghost Image Factor

**Remarks**

Date	Comments

# Quality Control Manual for Selenia Dimensions and 3Dimensions Systems

Appendix A: Quality Control Forms for the Medical Physicist

---

**This page is intentionally left blank.**



## Appendix B Quality Control Forms for the Radiologic Technologist



**Caution:**

If electronic forms or forms other than the forms listed in this appendix are used with the current revision of this manual, it is the responsibility of the user to verify that the alternative forms are equivalent to the forms printed in this manual.

Table 42: Quality Control Tests To be Performed by the Radiologic Technologist on All Systems

Quality Control Test Procedure	Frequency	Action Criteria	Section Title
DICOM Printer Quality Control	Weekly	Category B	<a href="#">DICOM Printer Quality Control</a> on page 85
Detector Flat Field Calibration (includes CEDM option)	Weekly	Category A	<a href="#">Detector Flat Field Calibration</a> on page 89
Geometry Calibration (Tomosynthesis Option)	Semiannually	Category A	<a href="#">Geometry Calibration (Tomosynthesis Option)</a> on page 92
Artifact Evaluation	Weekly	Category C	<a href="#">Artifact Evaluation</a> on page 94
Phantom Control Chart	Weekly	Category A	<a href="#">Phantom Image</a> on page 100
Signal-To-Noise and Contrast-To-Noise Measurements	Weekly	Category A	<a href="#">Signal-To-Noise and Contrast-To-Noise Measurements</a> on page 103
Compression Thickness Indicator	Biweekly	Category C	<a href="#">Compression Thickness Indicator</a> on page 110
Diagnostic Review Workstation Quality Control	Weekly	Category B	<a href="#">Diagnostic Review Workstation Quality Control</a> on page 112
Viewbox and Viewing Conditions	Weekly	Category B	<a href="#">Viewboxes and Viewing Conditions</a> on page 115
Visual Checklist	Monthly	Category C	<a href="#">Visual Checklist</a> on page 116
Repeat/Reject Analysis	Quarterly	Category C	<a href="#">Repeat/Reject Analysis</a> on page 117
Compression	Semiannually	Category A	<a href="#">Compression</a> on page 119

**This page is intentionally left blank.**



**This page is intentionally left blank.**

**Quality Control Manual for Selenia Dimensions and 3Dimensions Systems**

Appendix B: Quality Control Forms for the Radiologic Technologist

**SNR Calculation Worksheet**

<b>Date</b>	<b>Tech</b>	<b>Mean Beside Disk</b>	<b>-</b>	<b>Minus DC Offset (50)</b>	<b>=</b>	<b>Result</b>	<b>÷</b>	<b>Divide by Standard Deviation Beside Disk</b>	<b>=</b>	<b>Plot this number. Must be at least 40.</b>
			-	50	=		÷		=	
			-	50	=		÷		=	
			-	50	=		÷		=	
			-	50	=		÷		=	
			-	50	=		÷		=	
			-	50	=		÷		=	
			-	50	=		÷		=	
			-	50	=		÷		=	
			-	50	=		÷		=	
			-	50	=		÷		=	
			-	50	=		÷		=	
			-	50	=		÷		=	
			-	50	=		÷		=	
			-	50	=		÷		=	
			-	50	=		÷		=	
			-	50	=		÷		=	
			-	50	=		÷		=	
			-	50	=		÷		=	
			-	50	=		÷		=	
			-	50	=		÷		=	
			-	50	=		÷		=	
			-	50	=		÷		=	
			-	50	=		÷		=	
			-	50	=		÷		=	
			-	50	=		÷		=	
			-	50	=		÷		=	

**This page is intentionally left blank.**



**This page is intentionally left blank.**



### 1. DICOM Printer Quality Control

Year:

Month: 

--	--	--	--	--	--	--	--	--	--

  
 Day: 

--	--	--	--	--	--	--	--	--	--

  
 Initials: 

--	--	--	--	--	--	--	--	--	--

<b>DICOM Printer Control Chart</b>													
Remarks: <table border="1" style="width: 100%; height: 100px;"><tr><td> </td><td> </td><td> </td><td> </td><td> </td><td> </td></tr></table>							DICOM Printer Model: <table border="1" style="width: 100%; height: 30px;"><tr><td> </td></tr></table> DICOM Printer Serial #: <table border="1" style="width: 100%; height: 30px;"><tr><td> </td></tr></table>						
<table border="1" style="width: 100%; height: 100px;"><tr><td> </td><td> </td><td> </td><td> </td><td> </td><td> </td></tr></table>							<table border="1" style="width: 100%; height: 100px;"><tr><td> </td><td> </td><td> </td><td> </td><td> </td><td> </td></tr></table>						
<table border="1" style="width: 100%; height: 100px;"><tr><td> </td><td> </td><td> </td><td> </td><td> </td><td> </td></tr></table>							<table border="1" style="width: 100%; height: 100px;"><tr><td> </td><td> </td><td> </td><td> </td><td> </td><td> </td></tr></table>						
<table border="1" style="width: 100%; height: 100px;"><tr><td> </td><td> </td><td> </td><td> </td><td> </td><td> </td></tr></table>							<table border="1" style="width: 100%; height: 100px;"><tr><td> </td><td> </td><td> </td><td> </td><td> </td><td> </td></tr></table>						

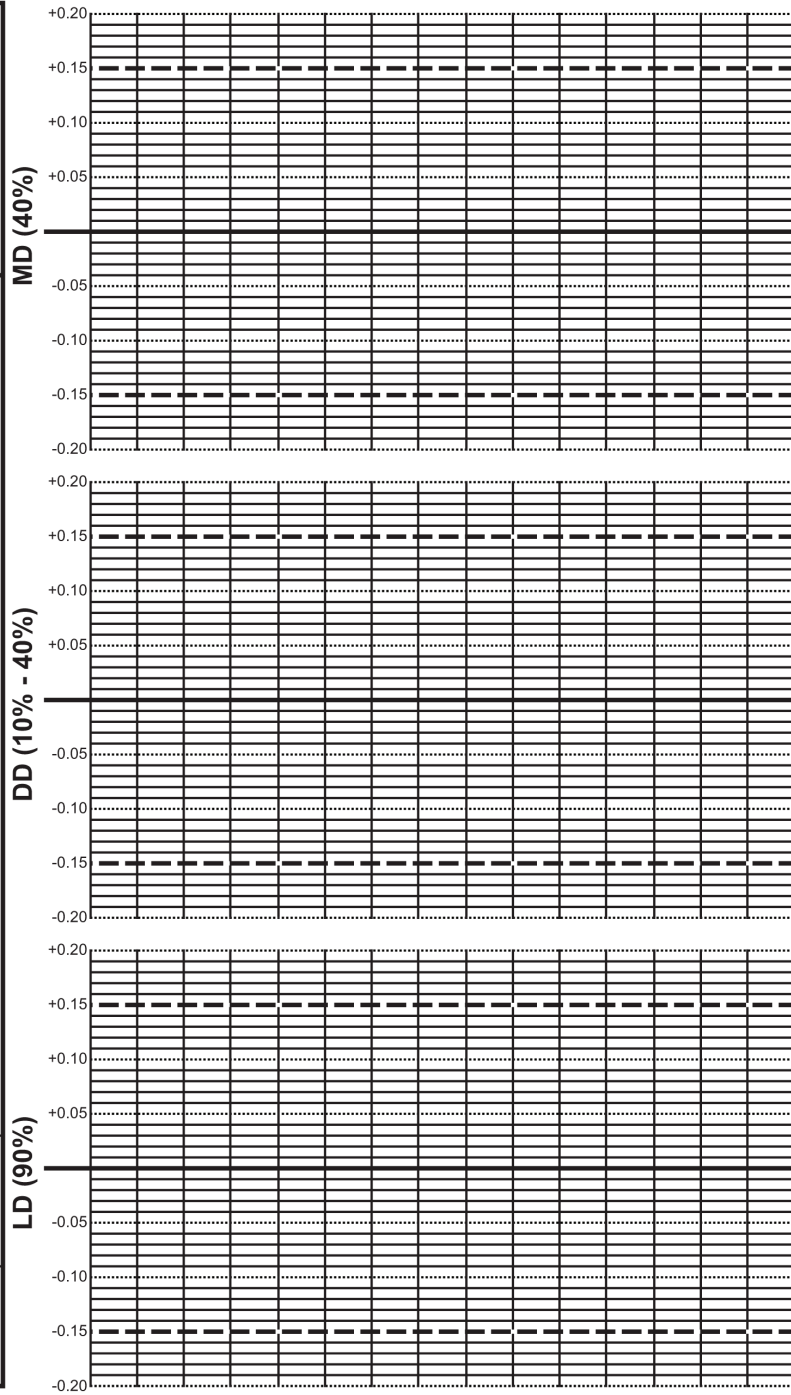

MD Base Value: \_\_\_\_\_ Date: \_\_\_\_\_ Initials: \_\_\_\_\_  
 DD Base Value: \_\_\_\_\_ Date: \_\_\_\_\_ Initials: \_\_\_\_\_  
 LD Base Value: \_\_\_\_\_ Date: \_\_\_\_\_ Initials: \_\_\_\_\_

# Quality Control Manual for Selenia Dimensions and 3Dimensions Systems

Appendix B: Quality Control Forms for the Radiologic Technologist

---

**This page is intentionally left blank.**



**This page is intentionally left blank.**

# Quality Control Manual for Selenia Dimensions and 3Dimensions Systems

## Appendix B: Quality Control Forms for the Radiologic Technologist

### 4a. System Artifact Evaluation

Year:																				
Date:																				
Initials:																				
Attenuator:	Acrylic				Acrylic				Acrylic				Acrylic							
kVp:																				
mAs:																				
Filter:	Rh	Ag	Al	Cu	Rh	Ag	Al	Cu	Rh	Ag	Al	Cu	Rh	Ag	Al	Cu	Rh	Ag	Al	Cu
Artifacts:																				
Acceptable?:																				

Year:																				
Date:																				
Initials:																				
Attenuator:	Acrylic				Acrylic				Acrylic				Acrylic							
kVp:																				
mAs:																				
Filter:	Rh	Ag	Al	Cu	Rh	Ag	Al	Cu	Rh	Ag	Al	Cu	Rh	Ag	Al	Cu	Rh	Ag	Al	Cu
Artifacts:																				
Acceptable?:																				

Year:																				
Date:																				
Initials:																				
Attenuator:	Acrylic				Acrylic				Acrylic				Acrylic							
kVp:																				
mAs:																				
Filter:	Rh	Ag	Al	Cu	Rh	Ag	Al	Cu	Rh	Ag	Al	Cu	Rh	Ag	Al	Cu	Rh	Ag	Al	Cu
Artifacts:																				
Acceptable?:																				

Remarks

Date:                      Action

**This page is intentionally left blank.**

# Quality Control Manual for Selenia Dimensions and 3Dimensions Systems

## Appendix B: Quality Control Forms for the Radiologic Technologist

### 4b. Printer Artifact Evaluation

Year:									
Date:									
Initials:									
Film Size:									
Artifacts:									
Acceptable?:									

Year:									
Date:									
Initials:									
Film Size:									
Artifacts:									
Acceptable?:									

Year:									
Date:									
Initials:									
Film Size:									
Artifacts:									
Acceptable?:									

Remarks

Date:	Action

**This page is intentionally left blank.**



**5a. Phantom Control Chart**

Phantom Serial #:		FFDM Serial #:	
Year:			
Month:			
Day:			
Initials:			
Filter:			
kVp:			
mAs:			
El:			

6			
5			
4			
3			
2			
1			
5			
4			
3			
2			
1			
5			
4			
3			
2			
1			

6			
5			
4			
3			
2			
1			
5			
4			
3			
2			
1			

6			
5			
4			
3			
2			
1			
5			
4			
3			
2			
1			

6			
5			
4			
3			
2			
1			
5			
4			
3			
2			
1			

6			
5			
4			
3			
2			
1			
5			
4			
3			
2			
1			

6			
5			
4			
3			
2			
1			
5			
4			
3			
2			
1			

6			
5			
4			
3			
2			
1			
5			
4			
3			
2			
1			

6			
5			
4			
3			
2			
1			
5			
4			
3			
2			
1			

6			
5			
4			
3			
2			
1			
5			
4			
3			
2			
1			

6			
5			
4			
3			
2			
1			
5			
4			
3			
2			
1			

6			
5			
4			
3			
2			
1			
5			
4			
3			
2			
1			

6			
5			
4			
3			

**This page is intentionally left blank.**



**This page is intentionally left blank.**

# Quality Control Manual for Selenia Dimensions and 3Dimensions Systems

## Appendix B: Quality Control Forms for the Radiologic Technologist

### 6. Signal-To-Noise Ratio (SNR) and Contrast-To-Noise Ratio (CNR)

Year:

Month:																				
Day:																				
Initials:																				
kVp:																				
mAs:																				
E.I.:																				

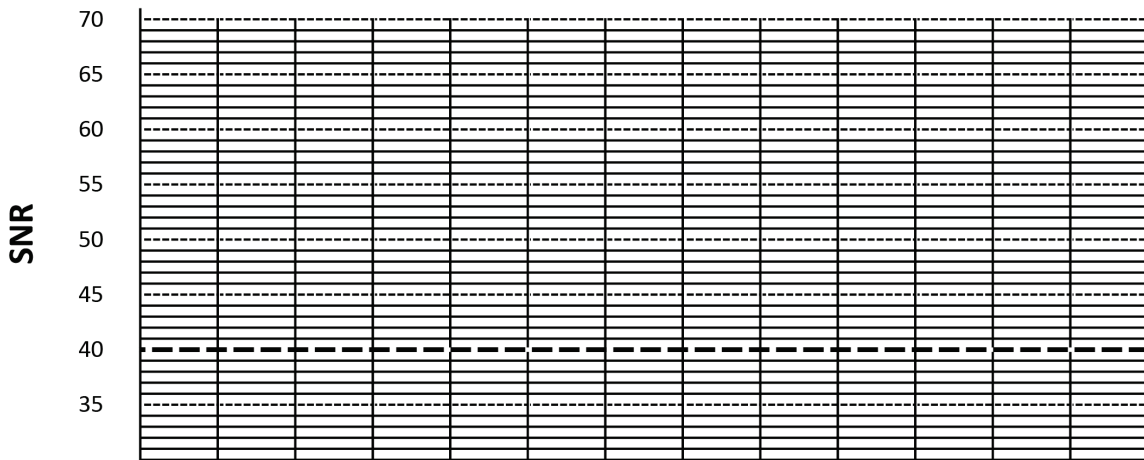

CNR Base Value: \_\_\_\_\_ Date: \_\_\_\_\_ Initials: \_\_\_\_\_

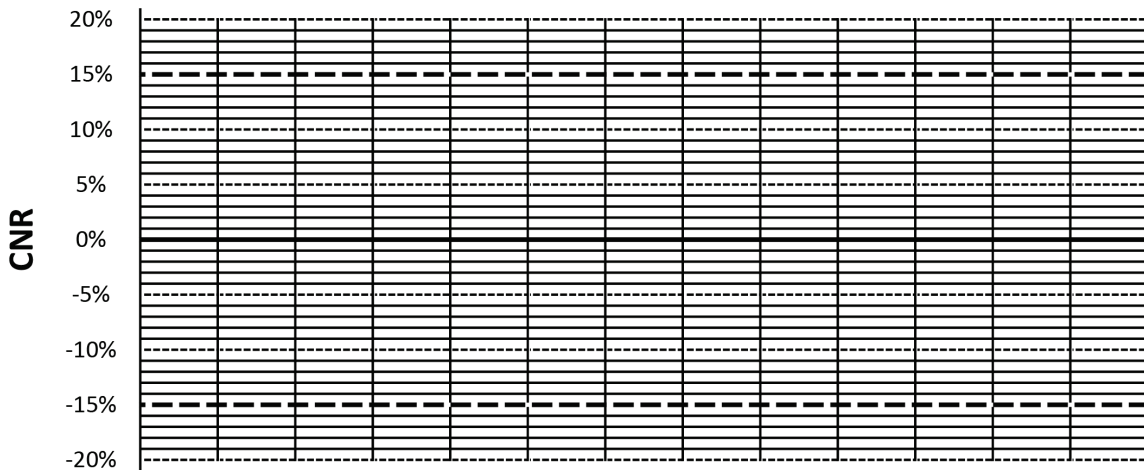

Remarks

Date:	Action

# Quality Control Manual for Selenia Dimensions and 3Dimensions Systems

Appendix B: Quality Control Forms for the Radiologic Technologist

---

**This page is intentionally left blank.**

# Quality Control Manual for Selenia Dimensions and 3Dimensions Systems

## Appendix B: Quality Control Forms for the Radiologic Technologist

### 7. Compression Thickness Indicator

Year:																					
Month:																					
Date:																					
Initials:																					

Phantom Serial #: \_\_\_\_\_

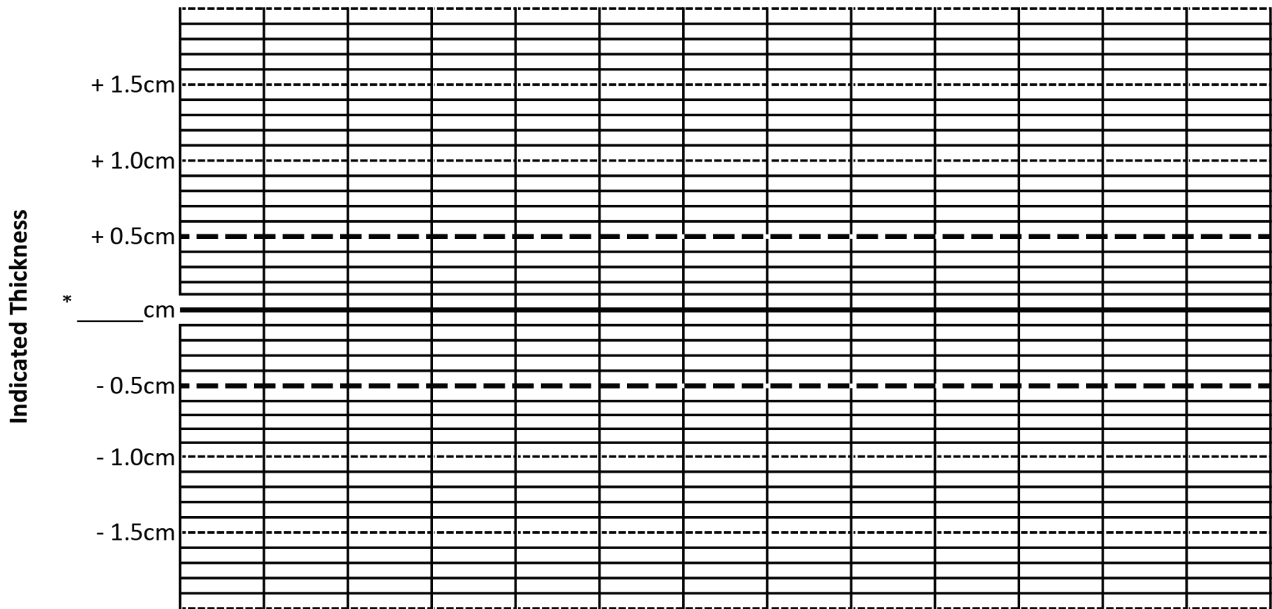

*\*Record the physical thickness of the ACR Phantom in this space.*

**Remarks**

Date	Action

**This page is intentionally left blank.**



## 8. Diagnostic Review Workstation Quality Control

Serial Number: \_\_\_\_\_

Year:				
Date:				
Initials:				
Pass/Fail:				

Year:				
Date:				
Initials:				
Pass/Fail:				

Year:				
Date:				
Initials:				
Pass/Fail:				

Year:				
Date:				
Initials:				
Pass/Fail:				

**Remarks**

Date	Action

**This page is intentionally left blank.**



**This page is intentionally left blank.**

# Quality Control Manual for Selenia Dimensions and 3Dimensions Systems

## Appendix B: Quality Control Forms for the Radiologic Technologist

### 10. Visual Checklist

		Year													
		Month	Jan	Feb	Mar	Apr	May	Jun	Jul	Aug	Sep	Oct	Nov	Dec	
		Date													
		Tech Initials													
<b>C-arm/Gantry</b>	SID indicator or marks														
	Angulation indicator														
	Detents/Locks (all)														
	Collimator Light														
	Smoothness of motion														
	Grid function														
	Compression device function														
	Compression thickness display														
	Compression force display														
<b>Acquisition Workstation</b>	Glass Shield														
	Exposure switches														
	Power Controls														
	Monitors														
	Technique Charts														
<b>Accessories</b>	Foot Pedals														
	Compression Paddles clean and not cracked														
	Faceshields clean and not cracked														
	Disinfection Materials Available														
<b>Other</b>	-----														
	-----														
	-----														
	-----														

P = Pass      F = Fail      NA = Not Applicable

**This page is intentionally left blank.**

**Quality Control Manual for Selenia Dimensions and 3Dimensions Systems**

Appendix B: Quality Control Forms for the Radiologic Technologist

**3, 11, and 12. Mammography Quality Control Checklist – DM and BT**

**Hologic MODEL:** \_\_\_\_\_

**Monthly, Quarterly, and Semi-Annual**  
*(date, initial and enter number where appropriate)*

Year												
Month	JAN	FEB	MAR	APR	MAY	JUN	JUL	AUG	SEP	OCT	NOV	DEC
Visual Checklist (monthly)												
Repeat/Reject Analysis (≤2% change) (quarterly)												
Compression Manual (≥25 lbs) (semiannually)												
Compression Auto (25-45 lb) (semiannually)												
Geometry Calibration (semiannually)												
Diagnostic Review Workstation QC (See SecurView QC Manual)												

**Date:**

**Test:**

**Comments:**

_____	_____	_____
_____	_____	_____
_____	_____	_____
_____	_____	_____
_____	_____	_____
_____	_____	_____
_____	_____	_____
_____	_____	_____
_____	_____	_____
_____	_____	_____
_____	_____	_____

**This page is intentionally left blank.**





**This page is intentionally left blank.**

## Appendix C Dose Conversion Tables for the Medical Physicist

**Glandular Dose (in mrad) for 1 Roentgen Entrance Exposure  
 W/Rh Target-Filter Combination with 4.2-cm 50/50 Breast**

HVL	X-ray Tube Voltage (kVp)												
	22	23	24	25	26	27	28	29	30	31	32	33	
0.300	152	157	163	166	170	173	175	177	179	182	184	187	
0.325	163	169	174	177	181	183	186	188	190	192	195	197	
0.350	175	180	185	188	191	194	196	198	200	202	205	207	
0.375	186	191	196	199	202	205	207	209	211	213	215	218	
0.400	198	203	207	210	213	215	217	219	221	223	226	228	
0.425	209	214	218	221	224	226	228	230	232	234	236	238	
0.450	221	226	230	232	235	237	238	240	242	244	246	248	
0.475	233	237	241	243	245	247	249	251	253	254	256	258	
0.500	244	248	252	254	256	258	260	261	263	265	267	269	
0.525	256	260	263	265	267	269	270	272	273	275	277	279	
0.550	267	271	274	276	278	279	281	282	284	285	287	289	
0.575	279	282	285	287	288	290	291	292	294	296	297	299	
0.600	290	293	296	297	299	300	301	303	304	306	308	310	
0.625	301	304	306	308	309	310	312	313	315	316	318	320	
0.650	312	314	317	318	320	321	322	323	325	326	328	330	
0.675	322	325	327	328	330	331	332	333	335	336	338	340	
0.700	333	335	337	339	340	341	342	343	345	346	348	350	
0.725	342	345	347	348	349	351	352	353	354	356	358	360	
0.750	352	355	357	358	359	360	361	363	364	366	368	369	
0.775	361	365	367	368	369	370	371	372	374	375	377	379	
0.800	369	374	376	377	378	379	380	382	383	385	387	389	

**Glandular Dose (in mrad) for 1 Roentgen Entrance Exposure  
W/Ag Target-Filter Combination with 4.2-cm 50/50 Breast**

HVL	X-ray Tube Voltage (kVp)															
	27	28	29	30	31	32	33	34	35	36	37	38	39			
0.400	222	226	229	231	234	236	239	241	244	246	248	250	252			
0.425	233	236	239	242	244	246	248	251	253	256	258	260	262			
0.450	244	247	249	252	254	256	258	260	263	265	267	269	271			
0.475	254	257	260	262	264	266	268	270	273	275	277	279	281			
0.500	265	267	270	272	274	276	278	280	282	284	286	288	290			
0.525	275	278	280	282	284	286	288	290	292	294	296	298	300			
0.550	286	288	290	292	294	296	298	299	301	303	305	307	309			
0.575	296	298	300	302	304	305	307	309	311	313	315	317	318			
0.600	306	308	310	312	313	315	317	319	320	322	324	326	328			
0.625	316	318	320	322	323	325	326	328	330	332	333	335	337			
0.650	326	328	330	331	333	334	336	338	339	341	343	344	346			
0.675	336	338	339	341	342	344	345	347	349	350	352	354	355			
0.700	346	348	349	350	352	353	355	356	358	359	361	363	364			
0.725	356	357	358	360	361	362	364	365	367	368	370	372	373			
0.750	365	367	368	369	370	372	373	375	376	378	379	381	382			
0.775	374	376	377	378	379	381	382	383	385	386	388	390	391			
0.800	384	385	386	387	388	390	391	392	394	395	397	398	400			
0.825	393	394	395	396	397	399	400	401	403	404	406	407	408			
0.850	402	403	404	405	406	407	409	410	411	413	414	416	417			
0.875	410	411	412	413	415	416	417	418	420	421	423	424	425			
0.900	419	420	421	422	423	424	425	427	428	429	431	432	434			

**Glandular Dose (in mrad) for 1 Roentgen Entrance Exposure  
W/AI Target-Filter Combination with 4.2-cm 50/50 Breast**

(Tomosynthesis Option)

HVL	X-ray Tube Voltage (kVp)															
	25	26	27	28	29	30	31	32	33	34	35	36	37	38	39	40
0.20	120	125	133	138	143	148	156	160	165	169	177	181	185	189	196	204
0.25	143	148	155	160	165	169	176	181	185	189	196	200	204	208	215	223
0.30	166	171	177	182	187	191	197	202	206	210	216	220	223	227	234	243
0.35	189	195	200	204	209	213	218	222	226	230	236	239	243	247	254	262
0.40	212	217	222	226	231	235	239	243	247	251	255	258	262	266	273	281
0.45	234	239	244	248	252	256	260	264	268	271	275	278	281	285	292	300
0.50	256	261	265	269	273	277	280	284	288	291	294	297	300	304	311	319
0.55	278	282	286	290	293	297	300	304	307	310	313	316	319	323	330	337
0.60	300	303	307	310	313	317	320	323	326	329	332	335	337	341	348	355
0.65	321	324	327	330	333	336	339	342	345	347	350	353	355	359	366	373
0.70	341	344	347	350	352	355	358	361	363	366	368	370	373	377	384	390
0.75	360	363	366	369	371	374	376	379	381	383	386	388	390	394	401	407
0.80	379	382	385	387	389	392	394	396	398	401	403	405	407	411	418	423
0.85	398	400	403	405	407	409	411	413	415	417	419	421	423	427	434	439
0.90	415	418	420	422	424	426	428	430	432	434	435	437	439	443	450	454
0.95	432	435	437	438	440	442	444	446	448	449	451	453	454	458	465	469
1.00	448	451	453	454	456	458	460	461	463	465	466	467	469	473	480	485

**(Tomosynthesis Option)**

**Glandular Dose (in mrad) for 1 Roentgen Entrance Exposure  
W/AI Target-Filter Combination with 4.2-cm 50/50 Breast**

HVL	X-ray Tube Voltage (kVp)											
	38	39	40	41	42	43	44	45	46	47	48	49
0.20	188	195	198	200	203	208	216	219	222	225	231	234
0.25	207	213	216	219	221	226	233	236	239	241	247	250
0.30	226	232	235	237	239	244	250	253	256	258	264	266
0.35	246	250	253	255	257	262	267	270	273	275	280	282
0.40	265	269	271	273	275	280	285	287	290	292	296	298
0.45	284	287	290	292	294	298	302	304	307	309	313	315
0.50	303	306	308	310	312	316	319	321	324	326	329	331
0.55	322	324	326	328	330	334	336	339	341	343	345	347
0.60	340	342	344	346	348	351	354	356	358	360	362	363
0.65	358	360	362	363	365	368	370	372	374	376	378	380
0.70	375	377	379	380	382	385	387	389	390	392	394	395
0.75	392	394	395	397	398	401	403	404	406	408	409	411
0.80	408	410	412	413	414	417	418	420	421	423	424	426
0.85	425	426	427	429	430	432	434	435	436	438	439	440
0.90	440	442	443	444	445	447	449	450	451	452	454	455
0.95	455	457	458	459	460	462	463	464	465	467	468	469
1.00	470	471	472	474	475	476	477	478	479	480	481	482

(CE2D Option)

**Glandular Dose (in mrad) for 1 Roentgen Entrance Exposure  
W/Cu Target-Filter Combination with 4.2-cm 50/50 Breast**

HVL (mm) \ kVp	X-ray Tube Voltage (kVp)									
	40	41	42	43	44	45	46	47	48	49
2.00	677	675	674	672	671	669	668	667	666	665
2.10	694	692	690	689	687	686	684	683	681	680
2.20	711	709	707	705	704	702	700	699	697	696
2.30	726	724	722	721	719	717	715	714	712	711
2.40	740	739	737	736	734	732	731	729	727	725
2.50	753	752	751	750	748	747	745	743	741	739
2.60	766	765	764	763	762	760	758	757	755	753
2.70	777	777	776	775	774	773	771	770	768	766
2.80	788	788	787	787	786	785	783	782	780	779
2.90	799	799	798	798	797	796	795	794	792	791
3.00	809	808	808	807	807	806	805	804	803	802
3.10	818	818	818	817	817	816	815	814	813	812
3.20	827	827	827	826	826	825	824	824	823	822
3.30	836	836	835	835	834	834	833	833	832	831
3.40	843	844	844	843	843	842	842	841	840	840
3.50	849	851	852	851	851	850	850	849	848	848
3.60	854	858	859	859	859	858	857	857	856	856
3.70	858	863	865	866	866	865	865	864	864	863
3.80	862	867	871	873	873	872	872	871	871	870
3.90	865	871	876	878	879	879	879	878	877	877
4.00	868	875	880	883	885	885	885	885	884	883





## Appendix D CNR Correction Tables



---

**Note**

All CNR correction values apply to software revisions 1.8.2 and above.

---



---

**Note**

Some AEC Tables may not be available in all geographic regions.

---



---

**Note**

System configuration may be different from the stated default AEC Tables. Refer to [Notes](#) on page 223 for comments recorded by the Service Engineer.

---



---

**Note**

To find the detector serial number, login to the application. From the "Select Function to Perform" page, select **ADMIN**. Select **ABOUT**. See the "Detector" section for the serial number.

---



---

**Note**

The system does not compensate for thickness in AUTO TIME mode. Thus, the exposure index should not be corrected by the CNR correction factors provided in this appendix when testing AEC in AUTO TIME mode.

---



---

**Note**

Stereotactic biopsy has its own AEC tables (section D.3), while biopsy under tomosynthesis shares AEC tables with tomosynthesis in STANDARD mode (section D.5).

---

*The CNR Correction Tables begin on the next page.*

## D.1 CNR Correction - Conventional (Contact)



**Note**

System default setting is AEC Table 4 for imaging under contact DM. Listed values apply to software revisions 1.8.2 and above.

---

**AEC Table 0 (Standard Screening Dose)**

Compression Thickness	Detector Serial #: XX6xxxxx	Detector Serial #: XX8xxxxx
2.0 cm	1.00	1.00
4.0 cm	1.00	1.00
6.0 cm	1.00	1.04
8.0 cm	1.15	1.23

**AEC Table 1 (Low Screening Dose)**

Compression Thickness	Detector Serial #: XX6xxxxx	Detector Serial #: XX8xxxxx
2.0 cm	1.00	1.00
4.0 cm	1.00	1.00
6.0 cm	1.00	1.02
8.0 cm	1.15	1.20

**AEC Table 2 (Limited Screening Dose)**

Compression Thickness	Detector Serial #: XX6xxxxx	Detector Serial #: XX8xxxxx
2.0 cm	1.00	1.00
4.0 cm	1.00	1.00
6.0 cm	1.00	1.01
8.0 cm	1.15	1.18

**AEC Table 3 (Contrast Screening Dose)**

Compression Thickness	Detector Serial #: XX6xxxxx	Detector Serial #: XX8xxxxx
2.0 cm	1.00	1.00
4.0 cm	1.00	1.00
6.0 cm	1.00	1.08
8.0 cm	1.00	1.10

**AEC Table 4 (Uniform Screening CNR Dose)**

<b>Compression</b>	<b>Detector Serial #:</b>	<b>Detector Serial #:</b>
<b>Thickness</b>	<b>XX6xxxxx</b>	<b>XX8xxxxx</b>
2.0 cm	1.00	1.00
4.0 cm	1.00	1.00
6.0 cm	1.30	1.35
8.0 cm	1.70	1.82

**AEC Table 5 (Uniform CNR Low Screening Dose)**

<b>Compression</b>	<b>Detector Serial #:</b>	<b>Detector Serial #:</b>
<b>Thickness</b>	<b>XX6xxxxx</b>	<b>XX8xxxxx</b>
2.0 cm	1.00	1.00
4.0 cm	1.00	1.00
6.0 cm	1.30	1.35
8.0 cm	1.73	1.85

**AEC Table 6 (Uniform CNR Screening Dose for DIN Standard)**

<b>Compression</b>	<b>Detector Serial #:</b>	<b>Detector Serial #:</b>
<b>Thickness</b>	<b>XX6xxxxx</b>	<b>XX8xxxxx</b>
2.0 cm	1.00	1.00
4.0 cm	1.00	1.00
6.0 cm	1.26	1.31
8.0 cm	1.70	1.82

**AEC Table 7 (Enhanced Uniform CNR Screening Dose)**

<b>Compression</b>	<b>Detector Serial #:</b>	<b>Detector Serial #:</b>
<b>Thickness</b>	<b>XX6xxxxx</b>	<b>XX8xxxxx</b>
2.0 cm	1.25	1.25
4.0 cm	1.20	1.20
6.0 cm	1.30	1.35
8.0 cm	1.70	1.82

## D.2 CNR Correction - Conventional (Magnification)



**Note**

System default setting is AEC Table 4 for imaging under magnification DM. Listed values apply to software revisions 1.8.2 and above.

---

### AEC Table 0 (Standard Magnification Dose)

<b>Compression Thickness</b>	<b>Detector Serial #: XX6xxxxx</b>	<b>Detector Serial #: XX8xxxxx</b>
2.0 cm	1.15	1.15
4.0 cm	1.15	1.15
6.0 cm	1.15	1.19
8.0 cm	1.15	1.28

### AEC Table 1 (Low Magnification Dose)

<b>Compression Thickness</b>	<b>Detector Serial #: XX6xxxxx</b>	<b>Detector Serial #: XX8xxxxx</b>
2.0 cm	1.15	1.15
4.0 cm	1.15	1.15
6.0 cm	1.15	1.18
8.0 cm	1.15	1.24

### AEC Table 2 (Limited Magnification Dose)

<b>Compression Thickness</b>	<b>Detector Serial #: XX6xxxxx</b>	<b>Detector Serial #: XX8xxxxx</b>
2.0 cm	1.15	1.15
4.0 cm	1.15	1.15
6.0 cm	1.15	1.18
8.0 cm	1.15	1.22

**AEC Table 3 (Contrast Magnification Dose)**

<b>Compression Thickness</b>	<b>Detector Serial #: XX6xxxxx</b>	<b>Detector Serial #: XX8xxxxx</b>
2.0 cm	1.15	1.15
4.0 cm	1.15	1.15
6.0 cm	1.15	1.18
8.0 cm	1.15	1.29

**AEC Table 4 (Enhanced Magnification Dose)**

<b>Compression Thickness</b>	<b>Detector Serial #: XX6xxxxx</b>	<b>Detector Serial #: XX8xxxxx</b>
2.0 cm	1.50	1.50
4.0 cm	1.50	1.50
6.0 cm	1.50	1.55
8.0 cm	1.50	1.67

### D.3 CNR Correction - Stereotactic Biopsy Option



**Note**

System default setting is AEC Table 0 for imaging under digital stereotactic biopsy. Listed values apply to software revisions 1.8.2 and above.

#### AEC Table 0 (Standard Stereotactic Biopsy Dose)

Compression Thickness	Detector Serial #:	Detector Serial #:
	XX6xxxxx	XX8xxxxx
2.0 cm	0.91	0.91
4.0 cm	1.00	1.00
6.0 cm	1.27	1.32
8.0 cm	1.76	1.88

### D.4 CNR Correction - CE2D Option



**Note**

System default setting is AEC Table 0 for imaging under CE2D. Listed values apply to software revisions 1.8.2 and above.

#### AEC Table 0 (Standard CE2D Dose)

Compression Thickness	Low Energy	
	Detector Serial #:	Detector Serial #:
	XX6xxxxx	XX8xxxxx
2.0 cm	1.00	1.00
4.0 cm	1.00	1.00
6.0 cm	1.82	1.91
8.0 cm	1.69	1.81
High Energy		
2.0 cm	0.72	0.72
4.0 cm	0.90	0.90
6.0 cm	1.71	1.71
8.0 cm	2.22	2.22

## D.5 CNR Correction - Tomosynthesis Option (15 Projections, STANDARD Mode)



**Note**

System default setting for imaging under tomosynthesis, 15 projections, STANDARD mode is AEC Table 0 for Combo, ComboHD, Tomo and TomoHD modes. AEC Table 0 is also used in biopsy under tomosynthesis. Listed values apply to software revisions 1.8.2 and above.

### D.5.1 For Software Versions 1.8.2 – 1.9.x on Selenia Dimensions and 2.0.x on 3Dimensions

#### AEC Table 0 (Standard Tomosynthesis Dose)

Compression Thickness	Detector Serial #: XX6xxxxx	Detector Serial #: XX8xxxxx
2.0 cm	0.70	0.70
4.0 cm	0.91	0.91
6.0 cm	1.46	1.55
8.0 cm	2.37	2.78

#### AEC Table 1 (Advanced Tomosynthesis Dose)

Compression Thickness	Detector Serial #: XX6xxxxx	Detector Serial #: XX8xxxxx
2.0 cm	0.70	0.70
4.0 cm	0.91	0.91
6.0 cm	1.46	1.55
8.0 cm	2.37	2.78

#### AEC Table 2 (Low Tomosynthesis Dose)

Compression Thickness	Detector Serial #: XX6xxxxx	Detector Serial #: XX8xxxxx
2.0 cm	0.91	0.88
4.0 cm	0.90	0.89
6.0 cm	1.51	1.59
8.0 cm	2.35	2.68

**D.5.2 For Software Versions 1.10.x and above on Selenia Dimensions and 2.1.x and above on 3Dimensions**

**AEC Table 0 (Standard Tomosynthesis Dose)**

<b>Compression Thickness</b>	<b>Detector Serial #: XX6xxxxx</b>	<b>Detector Serial #: XX8xxxxx</b>
2.0 cm	0.64	0.64
4.0 cm	0.91	0.91
6.0 cm	1.46	1.55
8.0 cm	2.37	2.78

**AEC Table 1 (Advanced Tomosynthesis Dose)**

<b>Compression Thickness</b>	<b>Detector Serial #: XX6xxxxx</b>	<b>Detector Serial #: XX8xxxxx</b>
2.0 cm	0.70	0.70
4.0 cm	0.91	0.91
6.0 cm	1.46	1.55
8.0 cm	2.37	2.78

**AEC Table 2 (Low Tomosynthesis Dose)**

<b>Compression Thickness</b>	<b>Detector Serial #: XX6xxxxx</b>	<b>Detector Serial #: XX8xxxxx</b>
2.0 cm	0.91	0.88
4.0 cm	0.90	0.89
6.0 cm	1.51	1.59
8.0 cm	2.35	2.68



## D.6 CNR Correction - Tomosynthesis Option (15 Projections, ENHANCED Mode)



**Note**

System default setting for imaging under tomosynthesis, 15 projections ENHANCED mode is AEC Table 0. Listed values apply to software revisions 1.8.2 and above.

### AEC Table 0 (Diagnostic Tomosynthesis Dose)

Compression Thickness	Detector Serial #: XX6xxxxx	Detector Serial #: XX8xxxxx
2.0 cm	0.57	0.57
4.0 cm	0.91	0.91
6.0 cm	1.55	1.68
8.0 cm	1.64	1.93

## D.7 CNR Correction - Tomosynthesis Option (30 Projections, STANDARD Mode)



**Note**

System default setting for imaging under 3D, 30 projections, STANDARD mode is AEC Table 0 for Combo and ComboHD modes. Table 2 is used for Tomo and TomoHD modes. AEC Table 0 is also used in biopsy under tomosynthesis. Listed values apply to software revisions 1.8.2 and above.

---

### AEC Table 0 (Standard Tomosynthesis Dose)

<b>Compression Thickness</b>	<b>Detector Serial #: XX6xxxxx</b>	<b>Detector Serial #: XX8xxxxx</b>
2.0 cm	0.91	0.88
4.0 cm	0.90	0.89
6.0 cm	1.51	1.59
8.0 cm	2.35	2.68

### AEC Table 1 (Low Tomosynthesis Dose)

<b>Compression Thickness</b>	<b>Detector Serial #: XX6xxxxx</b>	<b>Detector Serial #: XX8xxxxx</b>
2.0 cm	1.26	1.25
4.0 cm	1.05	1.05
6.0 cm	1.59	1.67
8.0 cm	2.59	2.93

### AEC Table 2 (Advanced Tomosynthesis Dose)

<b>Compression Thickness</b>	<b>Detector Serial #: XX6xxxxx</b>	<b>Detector Serial #: XX8xxxxx</b>
2.0 cm	0.80	0.76
4.0 cm	0.91	0.89
6.0 cm	1.48	1.56
8.0 cm	2.48	2.89

## D.8 CNR Correction - Tomosynthesis Option (30 Projections, ENHANCED Mode)



**Note**

System default settings for imaging under 3D, 30 projections ENHANCED mode is AEC Table 0. Listed values apply to software revisions 1.8.2 and above.

### AEC Table 0 (Diagnostic Tomosynthesis Dose)

Compression Thickness	Detector Serial #: XX6xxxxx	Detector Serial #: XX8xxxxx
2.0 cm	0.71	0.67
4.0 cm	0.91	0.90
6.0 cm	1.46	1.55
8.0 cm	2.56	3.03

## D.9 CNR Correction - Contrast Enhanced Biopsy Option

---



**Note**

System default setting is AEC Table 0 for imaging under contrast enhanced biopsy mode. Listed values apply to software revisions Selenia Dimensions 1.11 and above and 3Dimensions 2.2 and above.

---

### AEC Table 0 (Contrast Enhanced Biopsy Dose)

<b>Compression Thickness</b>	<b>Low Energy</b>	
	<b>Detector Serial #: XX6xxxxx</b>	<b>Detector Serial #: XX8xxxxx</b>
2.0 cm	0.86	0.86
4.0 cm	1.00	1.00
6.0 cm	1.58	1.66
8.0 cm	1.75	1.87

<b>Compression Thickness</b>	<b>High Energy</b>	
	<b>Detector Serial #: XX6xxxxx</b>	<b>Detector Serial #: XX8xxxxx</b>
2.0 cm	0.72	0.72
4.0 cm	0.90	0.90
6.0 cm	1.71	1.71
8.0 cm	2.22	2.22



# Quality Control Manual for Selenia Dimensions and 3Dimensions Systems

## Appendix D: CNR Correction Tables

---

---

---

---

---

---

## Appendix E Technique Tables

### Recommended Technique Table for Large Focal Spot (LFS)

Compressed Breast Thickness	Fatty Breast			Normal Breast			Dense Breast		
	kVp	mAs	Filter	kVp	mAs	Filter	kVp	mAs	Filter
1.0	25	25	Rh	25	30	Rh	25	35	Rh
2.0	25	50	Rh	25	58	Rh	25	65	Rh
3.0	26	72	Rh	26	84	Rh	26	95	Rh
4.0	28	92	Rh	28	106	Rh	28	120	Rh
5.0	29	128	Rh	29	152	Rh	29	176	Rh
6.0	31	171	Rh	31	194	Rh	31	216	Rh
7.0	30	131	Ag	30	147	Ag	30	163	Ag
8.0	32	143	Ag	32	163	Ag	32	182	Ag
9.0	34	156	Ag	34	176	Ag	34	195	Ag
10.0	36	156	Ag	36	174	Ag	36	192	Ag
11.0	37	190	Ag	37	205	Ag	37	220	Ag
12.0	39	170	Ag	39	185	Ag	39	200	Ag
13.0	39	235	Ag	39	253	Ag	39	270	Ag
14.0	39	310	Ag	39	335	Ag	39	360	Ag
15.0	39	360	Ag	39	360	Ag	39	360	Ag

### Recommended Technique Table for Small Focal Spot (SFS)

Compressed Breast Thickness	Fatty Breast			Normal Breast			Dense Breast		
	kVp	mAs	Filter	kVp	mAs	Filter	kVp	mAs	Filter
1.0	25	32	Rh	25	36	Rh	25	40	Rh
2.0	25	54	Rh	25	63	Rh	25	72	Rh
3.0	27	66	Rh	27	77	Rh	27	88	Rh
4.0	29	86	Rh	29	100	Rh	29	113	Rh
5.0	31	103	Rh	31	118	Rh	31	133	Rh
6.0	31	86	Ag	31	99	Ag	31	111	Ag
7.0	33	94	Ag	33	106	Ag	33	117	Ag
8.0	35	104	Ag	35	117	Ag	35	130	Ag
9.0	37	105	Ag	37	118	Ag	37	131	Ag
10.0	39	100	Ag	39	113	Ag	39	126	Ag
11.0	39	150	Ag	39	150	Ag	39	150	Ag
12.0	39	150	Ag	39	150	Ag	39	150	Ag
13.0	39	150	Ag	39	150	Ag	39	150	Ag
14.0	39	150	Ag	39	150	Ag	39	150	Ag
15.0	39	150	Ag	39	150	Ag	39	150	Ag

**Recommended Technique Table for Tomosynthesis Option**

Compressed Breast Thickness	Fatty Breast			Normal Breast			Dense Breast		
	kVp	mAs	Filter	kVp	mAs	Filter	kVp	mAs	Filter
1.0	26	33	Al	26	39	Al	26	45	Al
2.0	26	39	Al	26	46	Al	26	53	Al
3.0	28	41	Al	28	48	Al	28	55	Al
4.0	29	55	Al	29	65	Al	29	75	Al
5.0	31	62	Al	31	73	Al	31	84	Al
6.0	33	74	Al	33	87	Al	33	100	Al
7.0	35	91	Al	35	107	Al	35	123	Al
8.0	38	92	Al	38	108	Al	38	124	Al
9.0	42	87	Al	42	102	Al	42	117	Al
10.0	44	75	Al	44	88	Al	44	101	Al
11.0	46	67	Al	46	79	Al	46	91	Al
12.0	47	68	Al	47	80	Al	47	92	Al
13.0	48	65	Al	48	76	Al	48	87	Al
14.0	48	65	Al	48	76	Al	48	87	Al
15.0	49	59	Al	49	69	Al	49	79	Al



**Alternative Technique Table**

Compressed Breast Thickness	Fatty Breast			Normal Breast			Dense Breast		
	kVp	mAs	Filter	kVp	mAs	Filter	kVp	mAs	Filter
<3 cm									
3 to 5 cm									
5 to 7 cm									
>7 cm									



## Appendix F Scoring a Phantom

The system is equipped with a DICOM-conformant display. It is appropriate to score the phantom image on the display of the Acquisition Workstation following the procedure below.



1. Select the **ACR Phantom Conv** (Tomosynthesis Option: **ACR Phantom Combo**) thumbnail image in the Procedure screen on the Acquisition Workstation to display on the Preview screen.
2. Select the **Actual Pixels** button  to bring the image into full resolution. Examine the entire image for artifacts; use the magnification tool if necessary.

- Score the number of visible fibers in the image. Starting with the largest fiber, count each fiber as 1 if the full length is visible and is in the correct orientation. Continue counting downward with decreasing size. If a fiber is only partially visible and more than half of the length is seen, count the fiber as 0.5. Stop counting fibers after a score of 0.5 or 0 is observed (see the following two figures). Record the total number of fibers seen and the change from the previous year, if applicable, in the appropriate record form.

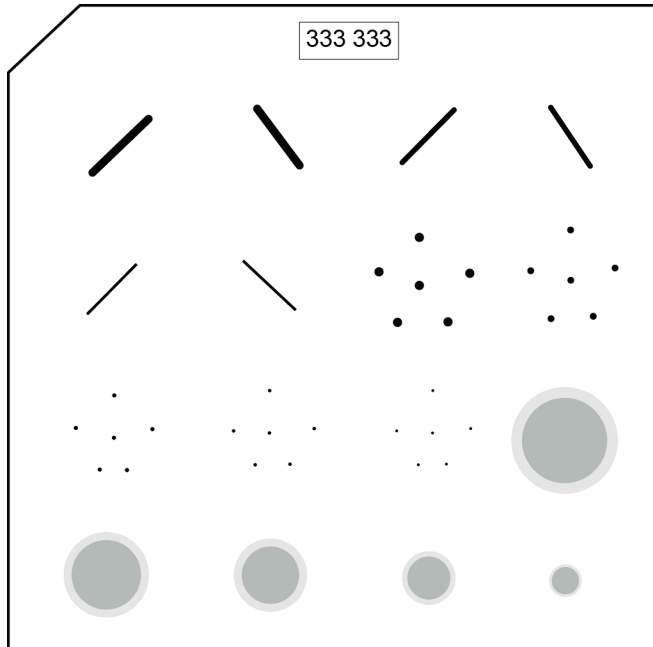

**Fibers: 6**  
**Speck Groups: 5**  
**Masses: 5**

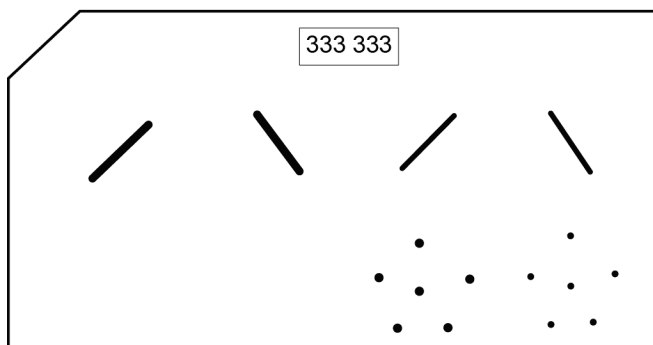

**Fibers: 3.5**  
**(not all, but at least half of the 4th fiber is visible)**

Figure 18: Examples of phantom diagrams for fiber scoring

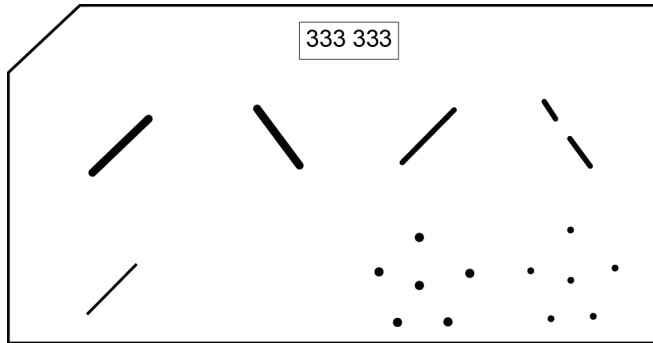

**Fibers: 3.5**  
 (the entire, unbroken length of the 4th fiber is not visible)

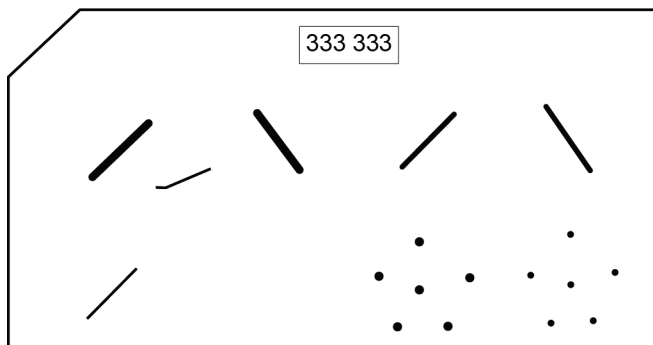

**Fibers: 4.0 (4.5 - 0.5)**  
 (the fiber-like artifact between the 1st and 2nd fiber must be subtracted from the last real fiber scored)

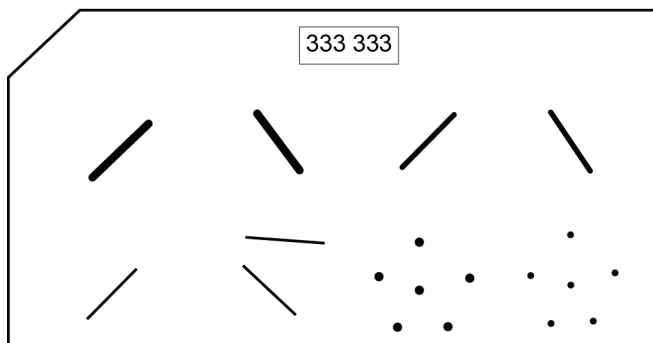

**Fibers: 5.0 (6.0 - 1.0)**  
 (the fiber-like artifact above the 6th fiber must be subtracted from the last real fiber scored)

Figure 19: More examples of phantom diagrams for fiber scoring

4. Score the number of visible speck groups, starting with the largest size of specks. Assign a score of 1 for each speck group where at least four specks out of the six are visible. Continue counting downward with decreasing size. Count a speck group as 0.5 if only two to three specks are visible out of the six specks. Stop counting after a score of 0.5 or 0 is seen (see the following figure). Record the total number of speck and the change from the previous year, if applicable, in the appropriate record form.

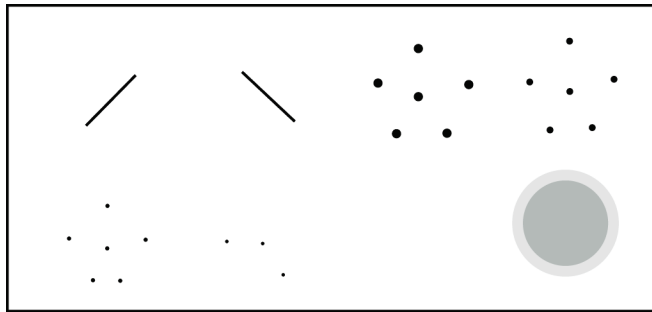

**Speck groups: 3.5**  
**(only 3 specks in the 4th speck group are visible)**

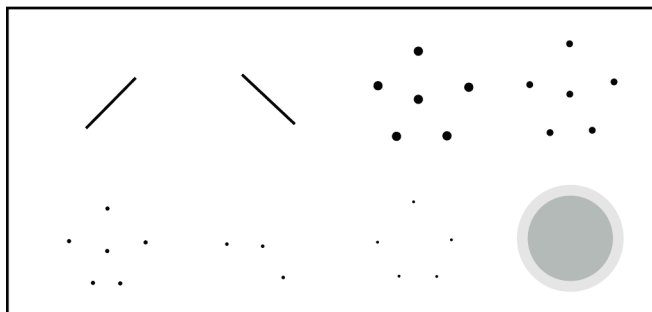

**Speck groups: 3.5**  
**(although 5 specks in the 5th speck group are visible, only 3 are visible in the 4th group)**

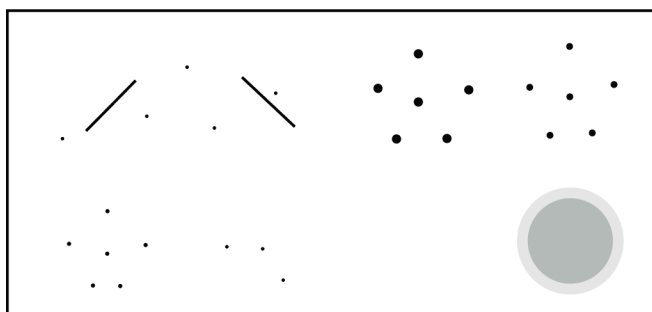

**Speck groups: 3.0 (3.5 - 0.5)**  
**(speck-like artifacts around the 5th and 6th fibers must be subtracted one for one from the specks in the last real speck group)**

*Figure 20: Examples of phantom diagrams for speck group scoring*

5. Score the number of visible masses, starting with the largest and counting downward in size. Assign a score of 1 for each mass that is in the correct location and is generally circular in shape (at least  $\frac{3}{4}$  of the mass perimeter is visible). Count a mass as 0.5 if the mass is only partially visible (not generally circular in shape) and is in the correct location. Stop counting after a score of 0.5 or 0 is reached (see the following two figures). Record the total number of masses seen and the change from the previous year, if applicable, in the appropriate record form.

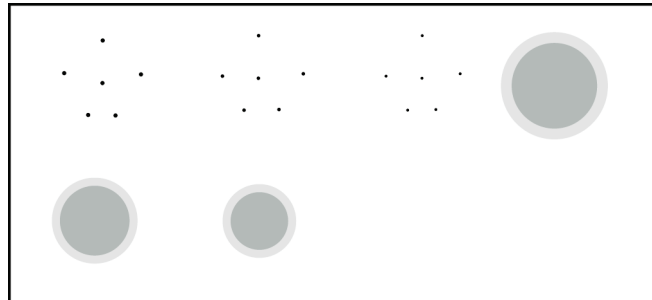

**Masses: 3.0**

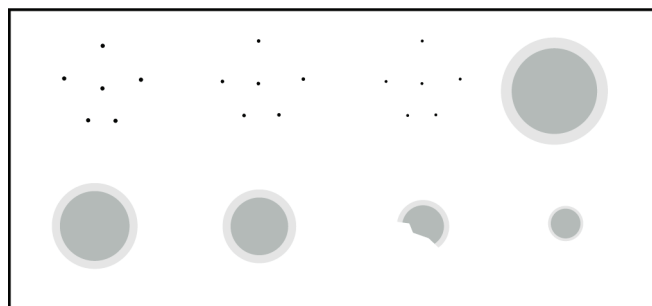

**Masses: 3.5**  
 (greater than  $\frac{3}{4}$  of the round perimeter should be visible for a full point)

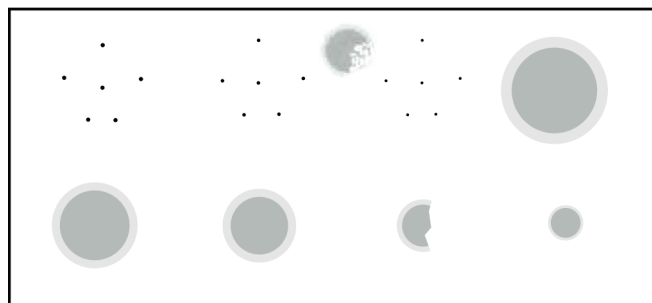

**Mases: 3.0 (3.5 - 0.5)**  
 (the mass-like artifact between the 4th and 5th speck groups must be subtracted from the last real mass scored)

Figure 21: Examples of phantom diagrams for mass scoring

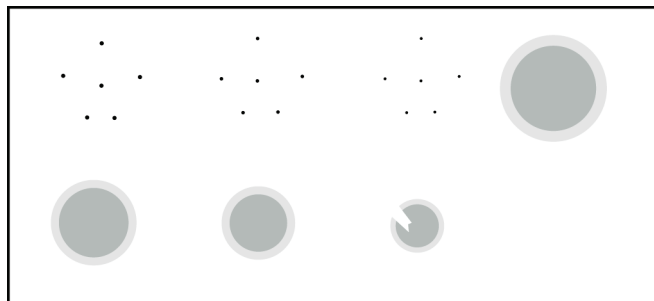

**Masses: 4.0**  
(the 4th mass is given a full point in spite of the linear artifact since it is still generally circular)

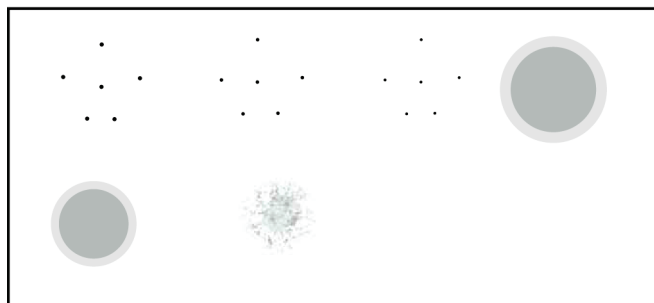

**Masses: 3.0**  
(although the 3rd mass has less contrast, it is still generally circular and is given a full point)

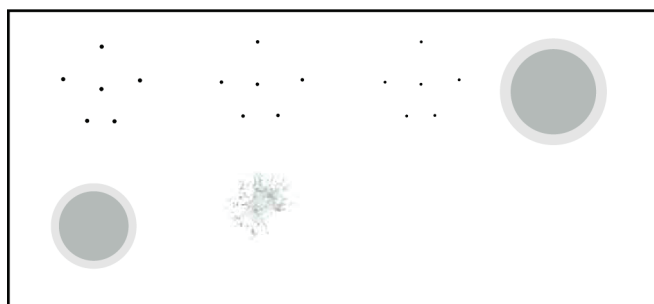

**Masses: 2.5**  
(the 3rd mass is of less contrast and is not generally circular)

*Figure 22: More examples of phantom diagrams for mass scoring*





6. Switch to the tomosynthesis reconstruction preview, scroll up to the reconstruction plane where the ACR elements are seen in focus and repeat steps 2 to 5 for the tomosynthesis part of the acquisition (Tomosynthesis Option).



---

**Note**

Critical evaluation of ACR Mammographic Accreditation Phantom images may reveal subtle artifacts or variances on phantoms that are not visible with screen-film image receptors. Artifacts associated with the phantom may be identified by repeating the phantom image with the phantom slightly rotated. Artifacts that move with the rotation of the phantom are caused by the phantom and not the imaging system. It is strongly recommended that the same phantom be used to evaluate phantom image quality over time. Should a different phantom (serial number) be used for this Quality Control test, the medical physicist must consider the possibility of manufacturing variability in the phantom itself when evaluating these images, even if the phantoms have the identical manufacturer and model number.

---



---

**Note**

It is important to review a sample of phantom images acquired by the radiologic technologist, if available, since the previous physicist's visit. Any problems in scoring of image quality by the technologist must be included as a corrective action.

---

# HOLOGIC®



Hologic Inc.  
36 Apple Ridge Road  
Danbury, CT 06810 USA  
1 800 447 1856

Brazilian Contact: Imex Medical Group do Brasil  
Rua das Embaúbas, 601- Fazenda Santo Antônio  
São José /SC - Brasil - 88104-561  
+55 48 3251-8800  
[www.imexmedicalgroup.com.br](http://www.imexmedicalgroup.com.br)



Hologic BVBA  
Da Vincilaan 5  
1930 Zaventem  
Belgium  
Tel: +32 2 711 46 80  
Fax: +32 2 725 20 87

CE  
0044

---

Refer to the corporate website for more facilities worldwide.

[www.hologic.com](http://www.hologic.com)