

**Viera**<sup>™</sup>  
Breast ultrasound by **Clarius**<sup>®</sup>

**HOLOGIC**<sup>®</sup>

**Viera**<sup>™</sup> **Portable**  
Breast Ultrasound  
User Manual

Disclaimer:

This disclaimer extends to all printed matter accompanying the Viera™ Portable Breast Ultrasound.

This manual is licensed under the Terms and Conditions available at [www.clarius.com/terms-conditions](http://www.clarius.com/terms-conditions). You may not use this manual except in compliance with the license. The information contained in these materials is proprietary and confidential to Clarius Mobile Health Corp. ("Clarius") and is provided for the sole use of the individual or entity to whom it is addressed and therefore these materials must be kept in the strictest confidence. No portion of this manual may be copied, reproduced, republished, modified, sold, disclosed, or distributed without the prior written permission of Clarius. Unauthorized copying or distribution of this manual, in addition to infringing copyright, may reduce the ability of Clarius to provide updates and current information to users.

Clarius has taken care to ensure the accuracy of this document, however, revisions may not be possible in all situations. Information in this document may be subject to change without notice, and Clarius assumes no liability for errors or omissions. Clarius reserves the right to make changes without further notice to any products herein to improve reliability, function, or design. Clarius may make improvements or changes in the products or programs described in this document at any time.

These materials may contain third-party copyright and/or trademark materials, the use of which has not always been specifically authorized by the intellectual property owner. All copyrights and/or trademarks contained in these materials are the sole and exclusive property of their respective owners.

"Clarius", the Clarius logo, "Ultrasound Anywhere," "Point-and-Shoot Ultrasound", "Act One", "Tri-Scanner", "My New Stethoscope", "It's About the Image," and the Clarius Live logo are trademarks or registered trademarks, and are the sole and exclusive property of Clarius.

The Clarius products/services referenced in this document may be covered by one or more patents or pending patent applications. See [www.clarius.com/patents](http://www.clarius.com/patents) for details.

All names used in Clarius (whether online, in print, or any other media) are fictitious and are used herein for the purposes of example and demonstration on how to use the Viera™ Portable Breast Ultrasound. Any similarity to real people is a coincidence.

© 2019 Clarius Mobile Health Corp.

All rights are reserved. Reproduction or transmission in whole or in part, in any form or by any means, electronic, mechanical or otherwise, is prohibited without the prior written consent of the copyright owner.

Published in Canada.

15-03-00055



Hologic Technical Support

USA Support Center: (877) 371-4372  
+1 (781) 999 7750  
[BreastHealth.Support@hologic.com](mailto:BreastHealth.Support@hologic.com)

European Support Center: +32 2 711 45 45  
[BE-Techsupport@hologic.com](mailto:BE-Techsupport@hologic.com)

Australia Support Center: 1800 264 073  
+61 2 9888 8000

# Table of Contents

<i>About This Manual</i> .....	1
<i>Target Audience</i> .....	1
<i>Document Conventions</i> .....	2
<b>Chapter 1: About the Viera™ Portable Breast Ultrasound</b> .....	<b>6</b>
Device Description .....	7
Scanner Dimensions.....	8
Product Usage .....	9
Indications for Use .....	9
Precautions .....	11
Hardware.....	12
Warranty.....	12
Disposal .....	12
Security .....	12
Information Security.....	12
Network Security.....	12
Confidentiality .....	13
Integrity .....	14
Availability .....	14
Accountability .....	14
System Requirements.....	14
<b>Chapter 2: Using the Viera™ Portable Breast Ultrasound</b> .....	<b>16</b>
Downloading the Clarius App .....	16
Turning the System on & off .....	17
Starting the Clarius App.....	17
Exiting the Clarius App.....	17
Inserting & Removing the Battery .....	17
Inserting the Viera™ Rechargeable Li-ion Battery .....	17
Removing the Viera™ Rechargeable Li-ion Battery .....	18
A Quick Tour .....	18
Screen Overview .....	18

Connecting Your Smart Device to the Viera™.....	21
Managing Exams .....	22
Error Messages .....	23
Imaging .....	24
Using the Measuring Tools .....	24
Updating the Viera™ Portable Breast Ultrasound .....	25
Software Updates .....	25
Firmware Updates.....	25
Maintenance .....	26
Hardware Maintenance.....	26
System Maintenance .....	28
<b>Chapter 3: Accessories .....</b>	<b>29</b>
Clarius Cart.....	29
Parts .....	30
Setting up.....	31
Using the Clarius Cart .....	32
Maintenance.....	33
Troubleshooting.....	33
Clarius Battery Charger Hub .....	33
Parts .....	34
Setting up.....	34
Using the Clarius Battery Charger Hub .....	35
Maintenance.....	36
Troubleshooting.....	36
Clarius Fan.....	36
<b>Chapter 4: Cleaning &amp; Disinfecting .....</b>	<b>38</b>
Cleaning.....	39
Cleaning the Viera™ Portable Breast Ultrasound .....	39
Cleaning the Clarius Cart .....	40
Cleaning the Clarius Battery Charger Hub .....	41
Cleaning the Clarius Fan.....	41
Disinfecting.....	41
Disinfecting the Viera™ Portable Breast Ultrasound .....	41
Disinfecting the Clarius Fan .....	43
Spaulding Classification .....	44

<b>Chapter 5: Safety</b> .....	<b>45</b>
About Diagnostic Ultrasounds.....	45
Interactions with Matter.....	45
Studies.....	45
Benefits & Risks.....	46
Safety Topics .....	46
Product Safety .....	47
Battery Safety .....	48
Cleaning Safety .....	49
Clinical Safety.....	51
Biological Safety .....	51
ALARA Principle.....	54
Fire & Electrical Safety .....	63
Electromagnetic Safety .....	64
<b>Chapter 6: References</b> .....	<b>70</b>
Compliance Statement.....	70
The Viera™ Portable Breast Ultrasound.....	70
Product Classification.....	70
Product Serial Number.....	70
System Specifications.....	71
Scanner Specifications .....	72
Standards.....	72
Biocompatibility.....	72
Chemical .....	73
Electrical Safety.....	73
Labeling.....	73
Quality .....	73
Security & Privacy.....	75
Wireless.....	76
Cleaners & Disinfectants .....	76
Cleaner & Disinfectant Usage.....	76
Cleaner & Disinfectant Details .....	77
Sterilization Systems .....	78
Glossary of Terms .....	78
Acoustic Outputs.....	78
Acoustic Artifacts.....	81
Known Issues .....	83

<i>Acoustic Output Tables</i> .....	84
Viera™: B-Mode .....	84
Viera™: Color Doppler Mode .....	85
Viera™: M-Mode .....	86
Viera™: Needle Enhance B-Mode .....	87
<i>Revision History</i> .....	88

# About This Manual



To obtain a printed copy of this manual at no additional cost, please contact Hologic Technical Support.

This document is licensed as part of the purchase of the Viera™ Portable Breast Ultrasound and meets applicable regulatory requirements. Use of this document by unauthorized persons is strictly prohibited.

This document contains the following information:

- About the Viera™ Portable Breast Ultrasound: Describes the product, and lists technical specifications, and its intended use.
- Using the Viera™ Portable Breast Ultrasound: Shows you how to get started and begin scanning, introduces you to the features and concepts, and helps you set up your system.
- Accessories: Describes additional accessories you can purchase for use with your Viera™ Portable Breast Ultrasound.
- Cleaning & Disinfecting: Explains how to clean and disinfect your scanner and its accessories.
- Safety: Outlines important safety standards, principles, and policies to follow when using the product.
- References: Offers information such as product standards, regulatory requirements, terms and conditions, glossary of terms, and acoustic output data.



Access to user documentation may be affected by: Internet availability and accessibility, website availability, and local electromagnetic interference.



## Target Audience

This document is written for trained medical professionals who operate and maintain your Viera™ Portable Breast Ultrasound. It contains instructions and reference material pertaining to the usage and maintenance of the product.



## Document Conventions





### Icons

Icon	Title of Icon	Description
	Alert	Possible risks beyond the reasonable control of Clarius.
	Do not do this	This icon indicates actions to avoid.
	Note	This icon indicates informative material or helpful suggestions.







### Symbols Glossary

The symbols shown in this document and on the Viera™ Portable Breast Ultrasound are compliant with current versions of the following standards: ISO 7000, ISO 7010, IEC 6417, (EN) ISO 15223-1, and EN 15986.

#### STANDARD: ISO 7000—GRAPHICAL SYMBOLS FOR USE ON EQUIPMENT—REGISTERED SYMBOLS





Symbol	Reference	Title	Description
	3082	Manufacturer	Indicates the medical device manufacturer, as defined in EU Directives 90/385/EEC, 93/42/EEC and 98/79/EC.
	2497	Date of manufacture	Indicates the date when the medical device was manufactured.
	2493	Catalogue number	Indicates the manufacturer's catalogue number so that the medical device can be identified.
	2498	Serial number	Indicates the manufacturer's serial number so that a specific medical device can be identified.
	2609	Non-sterile	Indicates a medical device that has not been subjected to a sterilization process.

**STANDARD: ISO 7000—GRAPHICAL SYMBOLS FOR USE ON EQUIPMENT—REGISTERED SYMBOLS**

	0621	Fragile; handle with care	Indicates a medical device that can be broken or damaged if not handled carefully.
	0626	Keep away from rain	Indicates a medical device that needs to be protected from moisture.
	0632	Temperature limit	Indicates the temperature limits to which the medical device can be safely exposed.
	0224	Measure humidity	Indicates the range of humidity to which the medical device can be safely exposed.
	1641	Operator's manual; operating instructions	Indicates the need for the user to consult the instructions for use.
	0434A	Caution	Indicates the need for the user to consult the instructions for use for important cautionary information such as warnings and precautions that cannot, for a variety of reasons, be presented on the medical device itself.
	1135	General symbol for recovery/recyclable	To indicate that the marked item or its material is part of a recovery or recycling process.











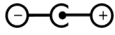





You may see some of these standard symbols on your Viera™ Portable Breast Ultrasound, accessories, and packaging:

**OTHER STANDARDS—GRAPHICAL SYMBOLS FOR USE ON EQUIPMENT—REGISTERED SYMBOLS**

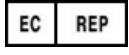
Symbol	Standard	Reference	Title	Description
	ISO 7010	M002	Refer to instruction manual/booklet	Indicates to read the instruction manual/booklet before starting work or before operating equipment or machinery.
	IEC 6417	5172	Class II equipment	To identify equipment meeting the safety requirements specified for Class II equipment according to IEC 60536.
	IEC 6417	5957	For indoor use only	To identify electrical equipment designed primarily for indoor use.
	IEC 6417	5333	Type BF applied part	To identify a type BF applied part complying with IEC 60601-1.

You may see these other symbols on your Viera™ Portable Breast Ultrasound, accessories, and packaging:

**OTHER GRAPHICAL SYMBOLS FOR USE ON EQUIPMENT**

Symbol	Title	Description
	Power connector	Indicates a barrel-type power connector.
	RoHS compliant	Identifies electrical and electronic equipment that meets the Restriction of Hazardous Substances (RoHS) Directive 2011/65/EU.
	European Conformity	Conforms to European Council Directive 93/42/EEC.
	FCC	Conforms to US Federal Communications Commission.
	CSA certification	Certified by the Canadian Standards Association. The number below this symbol indicates the contract number.
	Waste Electrical and Electronic Equipment	Requires separate collection for electrical and electronic equipment in compliance with the Waste Electrical and Electronic Equipment (WEEE) Directive. When accompanied by  or  , components of the device may contain lead or mercury, respectively, which must be recycled or disposed of in accordance with local, state, or federal laws. The backlight lamps in an LCD system monitor contain mercury.
<b>IP67</b>	Ingress protection rating	The equipment inside the enclosure is protected from tools and wires greater than 1.0 millimeters, is dust-tight, and is also protected from immersion up to 1 meter in depth for 30 minutes.
	DC	Direct current.
	GS1 DataMatrix	Identifies GS1 encoded DataMatrix.
	Global Medical Device Nomenclature Code	A system of internationally agreed generic descriptors used to identify all medical device products.
	Authorized representative in the European Community	Indicates the Authorized representative in the European Community.
	ANATEL	Conforms to the Brazilian Agency of Telecommunications.
	RCM	Regulatory Compliance Mark for Australia and New Zealand.
	NCC	Conforms to Taiwan's National Communications Commission.
	n/a	Do not stack boxes.
	n/a	Do not use knife to open.

**OTHER GRAPHICAL SYMBOLS FOR USE ON EQUIPMENT**

 Li-ion	n/a	Recycle Li-ion battery in accordance with local, state, and federal regulation
---	-----	--

# About the Viera™ Portable Breast Ultrasound



Install, operate, and maintain this product according to the safety and operating procedures in this manual, and only for its intended purpose. Always use the information in this document with sound clinical judgment and best clinical procedures.

This product is subject to the law in the jurisdiction that the product is used. Install, use, and operate the product only in ways that adhere to applicable laws or regulations, which have the force of law.



- Product package must be maintained with medical device. Do not dispose.
- Using the product incorrectly, or for purposes other than those intended and expressly stated by Clarius and/or Hologic, may relieve Clarius and/or Hologic or its agents from all or some responsibility for resultant noncompliance, damage, or injury.
- Using portable and mobile radio-frequency (RF) communications equipment can affect the operation of medical equipment.
- Operating this system in the presence of flammable gases or anesthetics can cause an explosion.
- Install and operate medical equipment according to electromagnetic compatibility (EMC) guidelines.
- Users are responsible for image quality and diagnosis.
- This device complies with part 15 of the FCC rules. Operation is subject to the following two conditions: (1) this device may not cause harmful interference, and (2) this device must accept any interference received, including interference that may cause undesired operation.
- This product has demonstrated EMC compliance under conditions that included the use of compliant peripheral devices. It is important that you use compliant peripheral

devices to reduce the possibility of causing interference to radios, televisions, and other electronic devices.



- Circumstances in the patient's environment may negatively impact the scanner and the exam. For example: (1) Chemicals and gases in the operating room. (2) Altitudes below -382 m or above 4000 m.
- Vulnerable patients, such as children and pregnant/nursing women, may be more prone to the exposure of acoustic energy when the scanner is used for prolonged periods.
- Biological incompatibility may exist between the scanner materials used and the biological tissues, cells, and body fluids of the patient/user, taking account of the intended purpose of the scanner.
- Using the scanner in the patient environment may be unsafe if the following conditions exist: (1) Extremes in humidity (RH<15% and RH>90%). (2) Ambient temperatures that are excessively high (40°C / 104°F) or excessively low (0°C / 32°F).
- Unqualified/untrained personnel purchasing and using the Viera™ Portable Breast Ultrasound may be unable to attain quality images.

Users will be trained medical professionals (e.g., doctors, nurses, technicians) with previous training in ultrasound. Images produced by the scanner are transmitted wirelessly to the user's smart device (tablet or smart phone).

Caution: Federal law restricts this device to sale by or on the order of a physician.

## Device Description

The Viera™ Portable Breast Ultrasound is a portable, general purpose, software controlled, diagnostic ultrasound system used to acquire and display high-resolution, real-time ultrasound data through a commercial off-the-shelf (COTS) Apple iOS or Android™ device. The Viera™ Portable Breast Ultrasound series of wireless scanners are Bluetooth and Wi-Fi-based scanners that communicate with a traditional tablet/smartphone via direct Wi-Fi to allow users to export ultrasound images and display in different modes of operation. The Viera™ Portable Breast Ultrasound houses a battery and internal power supplies, multichannel beamformer, prescan converter and Wi-Fi components. The battery is removable and comes with a separate charger.

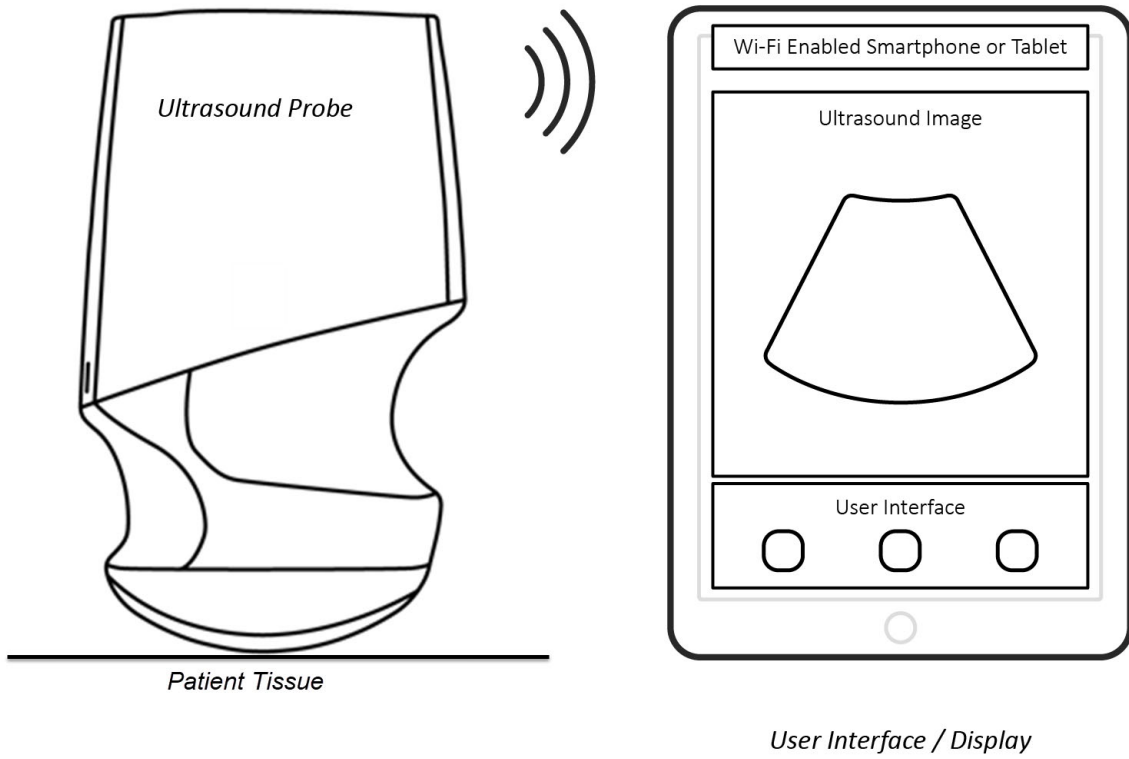

<b>Battery manufacturer</b>	Clarius
<b>Battery chemistry</b>	Li-ion
<b>Battery management</b>	JEITA guideline compatible charger, in-pack fuel gauge with protection circuitry, cell balancing, and temperature monitoring

## Scanner Dimensions

Item	Length (in/mm)	Width (in/mm)	Height (in/mm)	Weight (oz/g)
Viera™ Portable Breast Ultrasound Scanner	3.94/100	1.66/42	6.65/169	15.4/437

---

## Product Usage

### Indications for Use<sup>1</sup>

The Viera™ Portable Breast Ultrasound is a software-based ultrasound imaging system and accessories, intended for diagnostic imaging. It is indicated for diagnostic ultrasound imaging and fluid flow analysis in the following applications: abdominal, intra-operative (non-neurological), pediatric, small organ, musculo-skeletal (conventional, superficial), peripheral vessel, carotid, and procedural guidance of needles into the body.

The system is a transportable ultrasound system intended for use in environments where healthcare is provided by trained healthcare professionals<sup>2</sup>.

#### For Australia and New Zealand:

The Clarius Ultrasound Scanner is a software-based ultrasound imaging system and accessories intended for use in point-of-care imaging of medical conditions on the general public. Point-of-care applications will include:

- i. Emergency triage exam to look at trauma conditions
- ii. Procedure guidance to guide needles into the body
- iii. Other targeted diagnostic and measurement applications: fetal, abdominal, small organ, musculo-skeletal, urology, gynecology, cardiac adult, cardiac pediatric, and peripheral vessel.
- iv. The Clarius Ultrasound Scanner is intended for use in environments where healthcare is provided by trained medical professionals (for examples, doctors, nurses, and technicians).

- 
1. The following indications are specific to the Viera™ Portable Breast Ultrasound, which is within the Clarius Ultrasound Scanner family of scanners. For full indications for use for the Clarius Ultrasound Scanner system, please refer to the User Manual.
  2. IEC 60601-1-12 is valid in North America only.



Viera™ Scanner

**DEVICE NAME: VIERA™ SCANNER**

**INTENDED USE: DIAGNOSTIC ULTRASOUND IMAGING OR FLUID FLOW ANALYSIS OF THE HUMAN BODY AS FOLLOWS:**

Clinical Application		Mode of Operation						
General (Track 1 Only)	Specific (Tracks 1 & 3)	B	M	Color Doppler	Power Doppler	PW Doppler	Combined (Specify)	Other*
Ophthalmic	Ophthalmic	P						
Fetal Imaging & Other	Fetal							
	Abdominal	P	P	P	P	P	B+M; B+CD; B+PD; B+PWD	Note 1
	Intra-operative (Abdominal organs & vascular)	P	P	P	P	P	B+M; B+CD; B+PD; B+PWD	Note 1
	Laparoscopic							
	Pediatric	P	P	P	P	P	B+M; B+CD; B+PD	Note 1
	Small Organ (Thyroid, Prostate, Scrotum, Breast)	P		P	P	P	B+CD; B+PD; B+PWD	Note 1
	Neonatal Cephalic							
	Adult Cephalic							
	Trans-rectal							
	Trans-vaginal							
	Trans-urethral							
	Trans-esophageal (non-Cardiac)							
	Musculo-skeletal (Conventional)	P	P	P	P	P	B+M; B+CD; B+PD; B+PWD	Note 1
	Musculo-skeletal (Superficial)	P	P	P	P	P	B+M; B+CD; B+PD; B+PWD	Note 1
	Intravascular							
Other (Urology, Gynecology)								
Cardiac	Cardiac Adult							
	Cardiac Pediatric							
	Intravascular (Cardiac)							
	Trans-esophageal (Cardiac)							
	Intra-cardiac							
	Other (specify)							
Peripheral Vessel	Peripheral Vessel	P	P	P	P	P	B+M; B+CD; B+PD; B+PWD	Note 1
	Other (Carotid)	P	P	P	P	P	B+M; B+CD; B+PD; B+PWD	Note 1

N = new indication; P = previously cleared by FDA  
 Note 1: Needle Enhancement in B-Mode.

---

## Precautions

### For Use in Surgical Environments

Before you use the Viera™ Portable Breast Ultrasound for intra-operative procedures or in a surgical environment, follow the instructions for high-level disinfection (for instructions see *High-Level Disinfection* on page 42), then cover the Viera™ Portable Breast Ultrasound with a sheath:

- Use only CIVCO REF 610-1212, Safersonic DAN-33803-WG, and Safersonic DAN-33803-NT.
- Follow the usage instructions provided by the manufacturer.

When you have finished using the Viera™ Portable Breast Ultrasound, immediately clean it (for instructions see *Cleaning the Viera™ Portable Breast Ultrasound* on page 39), followed by another high-level disinfection.

If the sheath breaks during the intra-operative procedure, dispose the sheath and follow the same cleaning and high-level disinfecting process as above, then cover the Viera™ Portable Breast Ultrasound with a new sheath before continuing to use it.

### For Australia and New Zealand:

Do not use the Clarius Ultrasound Scanner in the following situations. Doing so may produce images with inaccurate results:

- Patients who have had surgery, which may have changed the composition of the examining tissue (for example, a mastectomy), as this could skew or alter the measured density.
- Patients whose bodies contain foreign artifacts (for example, implants), in the examining tissue.
- Ophthalmic use or any use causing the acoustic beam to pass through the eye.
- Intra-operative use (defined as introducing a scanner into a surgical incision or burr hole).

### For Use in Ophthalmic Procedures

Do not use the scanner for any use that may cause the acoustic beam to pass through the eye. Doing so may result in serious and irreversible harm to the eye of the patient.

## Hardware

### Warranty

Your Viera™ Portable Breast Ultrasound includes a one-year warranty. For full warranty details, go to <https://support.clarius.com/hc/en-us/articles/360019549672-Warranty-Coverage>. To purchase extended warranty, contact your Hologic representative.

### Disposal

Hologic is an active participant in the protection of the natural environment. The equipment and its accessories are designed and manufactured according to environmental protection guidelines, and the disposal of this equipment is intended to follow the same principles. The equipment materials that are essential for functionality are also harmful to the natural environment, therefore, you must dispose these materials appropriately.

For proper disposal of the Viera™ Portable Breast Ultrasound or any of its accessories, dispose it in accordance with local, state, and federal regulations. Alternatively, you can return it to Hologic.



The improper disposal of the Viera™ Portable Breast Ultrasound (when the battery is no longer working, or the scanner has exceeded its shelf life), or any of its accessories, adds hazardous materials to our landfills.

## Security

### Information Security

When entering data using the Clarius App, it is your responsibility to protect your security credentials (e.g. passwords) and the personal information of patients (e.g. names). The user is responsible for ensuring that patient health information is protected when using features in the Clarius App that may expose identifying information to other viewers (e.g. Clarius Live).

### Network Security

When connecting your smart device, use a network that supports Wi-Fi 802.11n. We recommend that you secure this network using WPA (Wi-Fi Protected Access) or WPA2 (Wi-Fi Protected Access II) as your security protocol.

For information on setting up your wireless network security, refer to your network equipment's documentation.



You may run into situations where no wireless access point is available. Using an untrusted wireless access point may allow malicious parties to see your Wi-Fi signals, perform harmful actions, and view communications between the two smart devices. When no secure access point is available, operate the Clarius App in Wi-Fi Direct mode, and it will automatically set up encryption.

For security purposes:

- Use secure passwords.
- Use secure wireless equipment using the latest firmware and software, and secure protocols.
- Lock your smart devices.

The following actions could introduce new risks to patients, operators, and third parties. It is your organization's responsibility to identify, analyze, evaluate, and control these risks:

- Changing network configurations.
- Connecting to additional networks or disconnecting from existing networks.
- Upgrading to new equipment or updating existing equipment.

## Confidentiality

Confidentiality of information is assured as follows:

- The scanner contains no patient-identifying information.
- When the scanner connects to a wireless network, it encrypts and stores the Wi-Fi password.
- The data transferred between the Viera™ Portable Breast Ultrasound and the Clarius App is encrypted.
- Image data contains no patient- or user-identifying information, and is transmitted in unencrypted form. If you want this data encrypted, connect to a:
  - Wi-Fi network where only trusted parties are permitted. The Wi-Fi network encrypts all image data sent from other Wi-Fi networks.
  - Wi-Fi Direct network. The Wi-Fi Direct network encrypts all image data, and because no other users are on the Wi-Fi Direct network, the image data is confidential.
- If no images are exported to Clarius Cloud or DICOM, the Clarius App stores them indefinitely. If images are exported, these images will be deleted from the device 10 days after export by default. You can change this default in the Clarius App's Settings page.

## Integrity

Integrity of the data transmitted between the Viera™ Portable Breast Ultrasound and the Clarius App is assured as follows:

- Authenticated encryption prevents malicious users from intercepting and modifying data.
- Integrity checks ensure completion and validity of data received. If any data is incomplete or invalid, it is discarded.
- TCP channels used over Wi-Fi ensures that data is delivered correctly. For transmitting image data, a UDP channel is used.

## Availability

If Wi-Fi connection is unattainable (e.g. Wi-Fi access points are unavailable, or the network is down), use Wi-Fi Direct network, which is managed by the smart device. Because Wi-Fi Direct network is a peer-to-peer connection using the Wi-Fi protocol, it disallows other users from connecting, thereby reducing DDOS (Distributed Denial of Service) attacks.

If the Wi-Fi Direct network is disrupted, the Viera™ Portable Breast Ultrasound continues to monitor itself, and shuts down after a period of inactivity. This reduces acoustic energy transmission and battery usage.

## Accountability

The concept of accountability does not apply to the Viera™ Portable Breast Ultrasound. However, ownership (i.e. the active user) of a smart device is assigned to one user at a time. Once you begin using the smart device, no other user can connect to the same smart device. All data transmitted between the smart device and the Clarius App is owned by the active user.

## System Requirements

Using the Viera™ Portable Breast Ultrasound on a smart device that does not meet the minimum requirements may result in low-quality images, unexpected results, and possible misdiagnoses.

To run the Clarius App, a smart device must meet or exceed the following minimum specifications:

Technical Features:

- Supports Bluetooth LE v4.0+
- Supports Wi-Fi 802.11n and Wi-Fi Direct
- 512 MB of memory

Operating System:

- Android™ 4.4.2 (API 19)+ or Apple iOS 9.1+

Processor:

- Dual core processor (CPU)
- ARM-based CPU architecture (for Android™-based devices)

Display:

- Resolution (in pixels) of 960x640 (or 640x960)
- Contrast ratio of 800:1
- Supports OpenGL ES 2.0



- Some sections of this User Manual may not apply to earlier versions of the Viera™ Portable Breast Ultrasound. Make sure you have the latest version of the Clarius App.
- Using a smart device that is too small may not have the necessary resolution for viewing small structures.

# Using the Viera™ Portable Breast Ultrasound

# 2

This chapter explains how to install and use your Viera™ Portable Breast Ultrasound safely and effectively.

Refer to *Safety* on page 45 before handling the Viera™ Portable Breast Ultrasound.

Your Viera™ Portable Breast Ultrasound is already activated and ready for use. You just need to download the Clarius App on an Apple iOS device or an Android™-based device.

## Downloading the Clarius App

Whether you are using Apple iOS or Android™, you must have an account and password set up with them.

Before installing the Clarius App, make sure your smart device meets the minimum requirements. See *System Requirements* on page 14.

### ▼To download the Clarius App:

1. Go to the Apple App Store or Google Play Store.
2. Search for the Clarius App.

If you cannot find the Clarius App, your smart device may not be meeting minimum specifications.

3. Tap the Install button and follow the instructions on your screen.

This downloads the application.

4. Tap the Open button.

This opens the Clarius App.

## Turning the System on & off

### Starting the Clarius App



Before you begin using the Viera™ Portable Breast Ultrasound, make sure you have the Viera™, and also your smart device with the Clarius App installed on it.

▼To open the Clarius App on your smart device:

Go to your smart device's home screen and tap .

The Clarius App opens to the sign-in screen.

### Exiting the Clarius App

▼To close the Clarius App:

Refer to your smart device's user manual.

## Inserting & Removing the Battery

If the battery is low or empty, recharge it by following the instructions on *Recharging Batteries* on page 26.

### Inserting the Viera™ Rechargeable Li-ion Battery

▼To insert the Viera™ Rechargeable Li-ion Battery into the Viera™ Portable Breast Ultrasound:

1. Make sure that the battery contacts are facing downward and that the battery label is facing the Viera™.
2. Slide the battery into the Viera™ until it locks into place.

When the battery contacts are detected, the Viera™ will emit a sound.



## Removing the Viera™ Rechargeable Li-ion Battery

▼To remove the Viera™ Rechargeable Li-ion Battery from the Viera™ Portable Breast Ultrasound:

1. Pull back on the latch located at the top of the Viera™.

This unlocks the battery.

2. Slide the battery out of the Viera™.

## A Quick Tour

### Screen Overview

#### Sign-in Page

When you open the Clarius App, it displays a sign-in screen. To use the scanner and Clarius App, you must have a Clarius account.

▼To sign in:

Open the Clarius App. It displays a sign-in screen for your user ID and password.

▼To sign out:

1. Select the **Sign Out** menu option.
2. Select **Yes**.

If you want to remain signed in, select No.



- **Create Account:** This takes you to the account creation page. To create a new account, enter your email address and then create yourself a strong password containing the following parameters:
  - At least six characters
  - At least one upper case, digit, or special character

Once registered, you can go to the Clarius Cloud to add details to your account.

- **Forgot Password?:** This takes you to the Clarius webpage for resetting your password.
- **Need Help?:** This takes you to the Clarius webpage containing contact and help information.



## Scanners Page

When you sign in, the Clarius App displays the Scanners page. This page lists active scanners in your vicinity. If your Clarius App cannot locate your scanner, either because the scanner is powered off or because it is located outside its Bluetooth range, the scanner is grayed out on the list.

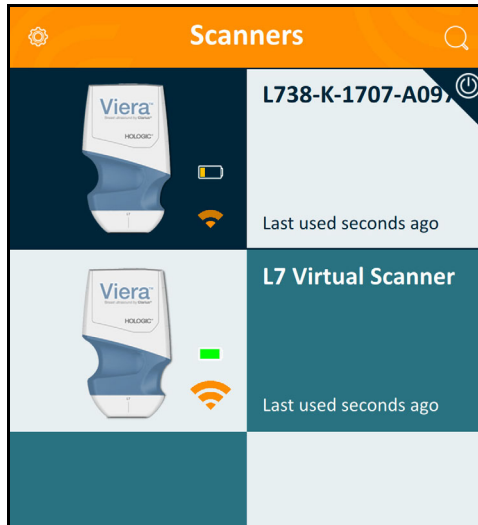
A  beside a Viera™ Portable Breast Ultrasound indicates that you have no access to it. To access this scanner, contact your administrator.



The Scanners page displays the following:

- A representative image of the scanner type.
- The currently selected scanner is displayed at the top of the list, indicated by . Tapping this icon disconnects the scanner from your smart device. It also turns off the scanner's power.
- The Bluetooth RSSI (signal strength) .
- Custom scanner name. You can define this in the Clarius Cloud.
- Length of time since last activity.

## Workflows Page

Exam types are characterized as workflows, a sequence of steps to complete an exam. Workflows guide you towards collecting all the information needed to produce a complete and accurate report for the reviewing physician.

Only those exam types applicable to the selected Viera™ Portable Breast Ultrasound are displayed in the Workflows page.

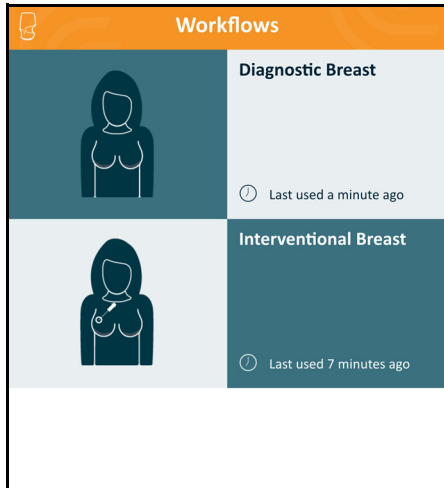

For more information on using the Clarius App and scanner, go to <https://support.clarius.com/hc/en-us>.

## Connecting Your Smart Device to the Viera™

 When this status icon is green, it indicates good wireless network connection. If it is yellow, orange, or red, it indicates varying degrees of congestion. This status icon is displayed on the Clarius App's live imaging page.

If the active scanner reaches its maximum idle time, the Clarius App disconnects your smart device from it, making the scanner available to other smart devices.

## Connecting Apple iOS Devices to Scanners

If you are using iOS 11 or a later version, it automatically connects to the network. If you are using an earlier version, follow these instructions:

▼To connect your Apple iOS device to a Viera™ Portable Breast Ultrasound:

1. From the Scanners page, tap the image or the name of the Viera™ Portable Breast Ultrasound you want to select.

This activates the selected Viera™ and attempts to connect it to your smart device's Wi-Fi. When the Viera™ emits an audible beep and its light flashes blue, the Wi-Fi Direct is enabled. When you hear another audible beep and the scanner light turns solid blue, the Viera™ is ready for Wi-Fi connection.



If the status light shows nothing (empty battery), or it is orange (low battery), recharge the battery.

Once the checkmark appears in the status circle, the Clarius App displays the name of the selected Viera™ Portable Breast Ultrasound's Wi-Fi network and the password. Remember the network name. The Clarius App has copied the password, so you do not need to memorize it.

2. Go to your smart device's Settings page, select the Wi-Fi section, and tap on the name of your Viera™ Portable Breast Ultrasound's Wi-Fi network. This automatically pastes the password in the field (this happens in the background).
3. Return to the Clarius App.

The status light on the selected Viera™ turns blue, indicating its connection to your smart device. When the scanner is not actively scanning, it remains in standby mode.

Workflows that apply to the selected Viera™ become enabled.

## Connecting Android™ Devices to Scanners

If you are using an Android™ device, it automatically connects to the network.

## Managing Exams



- Notifications and alerts from third-party applications may interrupt you or the Clarius App, thereby interfering with the exam. Configure your smart device in accordance with your institution's security policies.
- Vibration range that is too high for the scanner may cause the scanner to malfunction during an exam.
- Using improper gel type or combining different gel types may expose patients to risks and produce poor-quality images.

For proper transmission of the acoustic beam, use only Aquasonic 100, and use it only before its expiry date. Download the usage instructions from [www.parkerlabs.com/](http://www.parkerlabs.com/) and read all the information before operating the device.



Do not use:

- Lotion-based products or gels that contain mineral oil.
- Hand-sanitizing gels.
- Scanners left soaking in gel.

## Error Messages

The Viera™ Portable Breast Ultrasound displays no error messages. Instead, the Viera™ presents visual notifications in the form of status lights, and audible notifications in the form of status alerts.

### Status Lights

The following table defines the Viera™ Portable Breast Ultrasound's status lights:

Color	Display	Meaning
Blue	Flashing	Scanner is booting up.
Blue	Solid	Scanner is ready for a Wi-Fi connection, or has a connection and is not imaging.
Green	Solid	Scanner is imaging.
Orange	Flashing	Battery is low.
Orange	Solid	Internal communications error. <sup>a</sup>
Red	Flashing	Battery is critically low.
Red	Solid	Critical boot-up error has occurred. <sup>a</sup>
Purple	Flashing	Software/firmware is updating. Do not remove battery.

- a. Remove the battery from the scanner, wait 10 seconds, re-insert the battery, and re-connect it to your smart device. If symptoms persist, contact Hologic.

### Audible Notifications

The following table defines the audible indicators the Viera™ Portable Breast Ultrasound emits:

Sounds	Meaning
1 short beep	Wi-Fi Network connected
2 short beeps	Wi-Fi Direct enabled
2 quick beeps	Scanner components are ready
3 quick beeps	Bluetooth is ready
2 tone-increasing pitches	Power on
2 tone-decreasing pitches	Power off
1 beep every few seconds	Critically low battery
4 long alerts	Embedded processor is preparing for software update
4 short beeps	No network connected

4 quick beeps	App Find Request (based on selected ringtone)
8 long alerts	App Find Request (important)

## Imaging

When you go to the image acquisition page to begin an exam, the Viera™ Portable Breast Ultrasound automatically switches from standby mode to scanning mode. For instructions on using the imaging tools, go to <https://support.clarius.com/hc/en-us>.

A typical use of the Viera™ is described as five continuous scanning minutes followed by 10 minutes in standby mode (or turned off).

## Using the Measuring Tools

### Measurement Accuracy

You can use the ultrasound system to make measurements on ultrasound images. The measurements are then used with other clinical data to make a diagnosis.

Never make a diagnosis based solely on measurements. When quantifying data, consider other factors. The accuracy of each measurement is highly dependent on image quality, which in turn is highly dependent on system design, operator scanning technique, familiarity with system controls, and patient echogenicity.



You are responsible for image quality and diagnosis. Ensure that the data used for inspection and diagnosis is sufficient, both spatially and temporally, for the measurement method.

### Measurement Accuracy Table

Each figure below is derived from the sum of all parts of the Viera™ Portable Breast Ultrasound.

#### 2D MEASUREMENT ACCURACY

Scanner	Measurement	System Tolerance	Range
All scanners	Axial Distance	< ± 2%	0 – 32 cm
	Lateral Distance	< ± 2%	0 – 32 cm



Inaccurate measurements or misinterpretation of results taken from an exam may lead to misdiagnosis.

## Doppler Sensitivity

The following table shows the Doppler sensitivity of the Viera™ Scanner.

Scanner	Sensitivity	Depth (cm)	Flow (mL/sec)
Viera™	Power/Color Doppler depth sensitivity	5.0 cm	
	Power/Color Doppler flow sensitivity at depth	5.0 cm	0.1 ml/sec
	PW Doppler depth sensitivity	5.6 cm	
	PW Doppler flow sensitivity	5.0 cm	0.1 ml/sec

# Updating the Viera™ Portable Breast Ultrasound

## Software Updates

▼To update the software:

Go to the Apple App Store or the Google Play store.

## Firmware Updates

If a Viera™ software update is required, the Clarius App will notify you.

▼To update the firmware:

Tap **Update**.

During the updating process, do not remove the battery. If the battery level is too low, the system will decline the update.

During the update, the Viera™ emits a purple flashing light. Also, a purple indicator displays at the top right of the screen. Once the update is complete, the Viera™ light turns blue.



## Maintenance

The scanner routinely performs automated maintenance of the scanner itself. The user must perform routine maintenance for battery health. Prior to and after use, the user must also clean and disinfect the Viera™ Portable Breast Ultrasound and battery according to the instructions in *Cleaning & Disinfecting* on page 38.

Perform maintenance regularly and as needed. The system must be serviced by trained personnel only.



Failing to regularly maintain or verify the Viera™ Portable Breast Ultrasound may lead to undetected performance errors.

## Hardware Maintenance

### Testing Scanners

When you turn on the system, the scanner powers up and automatically tests its internal components. The Viera™ Portable Breast Ultrasound's LED will light up and you will hear a two-tone beep. The table below defines these conditions:

Battery Condition	Priority	Visual Indication	Audible Indication
Low battery	Low	Orange flashing status LED	None
Critically low battery	Low	Red flashing status LED	1 beep every few seconds

Also, the system runs a series of tests in the background. If your smart device is not connected to a wireless or cellular network, the logs are queued until you have network connectivity. For more information, please contact Hologic Technical Support.

### Recharging Batteries

Because the Viera™ Portable Breast Ultrasound is battery-operated, you must recharge the battery when necessary. An empty battery takes approximately 1 ½ hours to fully charge. A full battery has approximately 45 minutes of typical scanning time and can last up to two weeks in sleep mode. Charge the battery at least once a month to ensure proper functionality.

The battery power level is displayed on the screen. Battery warning notifications from Viera™ Portable Breast Ultrasounds in sleep mode via BLE are displayed to the user using the standard notification services of the smart device running the Clarius App.



When you receive your Viera™ Portable Breast Ultrasound, charge the battery to 100% before use.



Charge the battery using only the specified charger.

If you turn on the Viera™ Portable Breast Ultrasound and leave it untouched, it will go through the following modes to help reduce temperature and battery power:

1. After three seconds, it decreases frame rate.
2. After 30 seconds of decreased frame rate, it freezes.
3. After 10 seconds in freeze mode, it goes idle.
4. After 15 minutes of idle time, it shuts down.



Do not use the Viera™ Battery Charger in air ambulances, regular ambulances, or the EMS environment in general.



- Charging the battery in a rotary-wing airborne ambulance may cause the battery charger's power supply to interfere with the aircraft's electrical system, causing a malfunction that could lead to failure of control, instrumentation, and communication systems.<sup>1</sup>
- Connecting the battery charger to a power supply that is not manufactured by Clarius may have the incorrect voltage/current, which could damage the battery charger.

▼To charge the Viera™ Rechargeable Li-ion Battery in the Viera™ Battery Charger:

1. Connect the line cord of the AC power adapter to an indoor electrical outlet.
2. Connect the AC power adapter to the receptacle on the battery charger.
3. Remove the battery from the Viera™ Portable Breast Ultrasound by following the instructions on *Removing the Viera™ Rechargeable Li-ion Battery* on page 18.
4. Insert the battery into a slot on the battery charger.

The charger displays the following status lights:

- Orange: Battery is currently charging.
- Green: Battery is fully charged.

---

1. Statement applies to North America only.

## Storing Scanners

To protect your Viera™ Portable Breast Ultrasound:

- Dry them thoroughly before storage.
- Avoid storing them in extreme temperatures.
- Avoid placing them under direct sunlight for prolonged periods of time. This will not impact the Viera™ Portable Breast Ultrasound's safety and performance but may discolor the housing's finish.
- Store them separately from other equipment.
- Make sure stored batteries have at least 40% charge.



The scanner may degrade in performance or become unusable if stored or transported in ambient temperatures below -20°C (-4°F) or above 50°C (122°F).

## System Maintenance

### Sending Activity Logs

Select the Support menu option to go to the Support page and select the Submit Logs button. This downloads logs from the Viera™ Portable Breast Ultrasound, then combines them with the logs from the Clarius App. This bundle is then sent to the Clarius Cloud where they can be retrieved by a Hologic Technical Support staff. The log files contain diagnostic information.

If the log files grow too large, you may want to delete them to save space on your smart device. To delete the log files, go to the Settings menu.

# Accessories

# 3

To order these additional accessories, contact your Hologic representative:

- Clarius Cart: A roll stand with a basket, a locking storage bin, and a Clarius Battery Charger Hub.
  - assembly (CIDN 50-02-00033)
  - package (CIDN 99-02-00039)
- Clarius Fan (CIDN 99-02-00028): Attaching this fan to the Viera™ Portable Breast Ultrasound allows for longer scanning time.
- Clarius Battery Charger Hub: A battery charger that can charge up to five batteries and a USB charger that can charge two smart devices (smart phones or tablets).
  - assembly (CIDN 50-02-00039)
  - package (CIDN 99-03-00019)
- Viera™ Rechargeable Li-ion Battery (CIDN 81-02-00001, 81-02-00023)
- Viera™ Battery Charger (CIDN 81-02-00002, 81-02-00024)

## Clarius Cart

The Clarius Cart is a separate accessory that you can purchase for your Viera™ Portable Breast Ultrasound. The Clarius Cart combines a basket, a locking storage bin, and a Clarius Battery Charger Hub.

An external power supply is used to connect the Clarius Cart to the AC wall outlet using the supplied power cord.

The Clarius Cart is designed for use in professional healthcare facilities. The device is not intended to contact the patient during normal use. It is not to be used in emergency medical services

environments including during patient transport or the home healthcare environment. The Clarius Cart is to be used while attached to a roll stand. It is not to be placed within 1.5m of the examination table or patient bed.

The Clarius Cart is designed to be used with the Viera™ Rechargeable Li-ion Battery.

## Parts

The Clarius Cart is made up of the following parts:

- A fully-assembled Clarius Cart (CIDN 50-02-00033).
- A power supply (CIDN 50-02-00024) with a cord that is compatible with your country's socket and voltage.



Figure 1: Clarius Cart attached to a roll stand

Before you begin using your Clarius Cart, follow the cleaning instructions. See *Cleaning the Clarius Cart* on page 40.

## Technical Specifications

- Input: 12 VDC, 11.5 A
- Output: 8.4 VDC, 1.5 A x 5 (charger), 5.0 VDC, 2.3 A x 2 (USB)
- Protection Against Electric Shock: Class II
- Applied Part: None
- Ingress Protection: IP00
- Mode of Operation: Continuous

## System Specifications

	Operating Limits	Transportation & Storage Limits
Pressure	620 hPa to 1060 hPa (3,954 m to -38 m)	n/a
Humidity	15% to 95% <sup>s</sup>	0% to 95%
Temperature	10°C (50°F) to 40°C (113°F)	-20°C (-4°F) to 50°C (122°F)

## Maximum Working Load

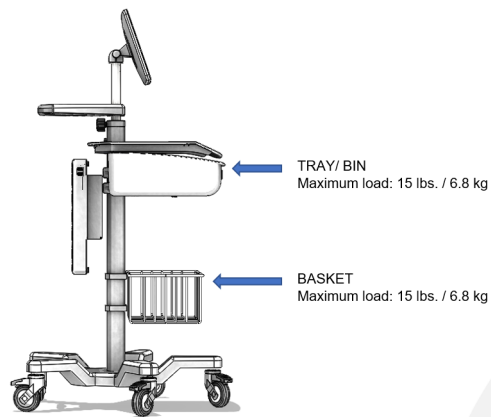

## Setting up

### ▼To use the Clarius Cart:

1. Insert the DC power connector into the Clarius Cart.
2. Connect the AC power cord to the power supply.
3. Insert the AC Male Plug into a power source.

The Clarius Cart is now ready to use.



- Do not place the Clarius Cart within 1.5m of the examination table/patient bed.
- Do not touch the patient and the Clarius Cart at the same time.
- If the AC power cord is damaged, contact Hologic for a replacement.
- Do not move the Clarius Cart while the upper section is extended. Adjust the upper section to its lowest position before transport.

## Using the Clarius Cart

### Using the Clarius Battery Charger Hub

▼To charge the Viera™ Rechargeable Li-ion Battery:

1. Remove the battery from the scanner.
2. Insert the battery into one of the battery slots. There will be a click when the battery is fully inserted.

If you are having problems inserting the battery, start by placing the battery in the charging slot, press down on the battery edge closest to the front of the Clarius Cart then roll the battery towards the back until you hear the click.

It takes approximately 1 ½ hours for an empty battery to fully charge.

Each charger displays the following status lights:

- Orange: Battery is currently charging.
- Green: Battery is fully charged.
- Off: No battery installed, battery not inserted fully, no power connected, or a problem with the battery.



Do not touch battery charger contacts. Only charge Viera™ Rechargeable Li-ion Battery.

### Using the Smart Device Charger

The Clarius Cart can charge any smart device that is used with the Viera™ Portable Breast Ultrasound.

▼To charge your smart devices:

1. Connect the smart device's charging cable to the smart device as described in the smart device's user manual.
2. Connect the opposite end of the charging cable to one of the two USB Type-A ports on the back of the Clarius Cart. Charge status will be indicated on the smart device.



Do not touch the patient while touching the USB ports. Do not touch the patient with any device connected to the USB ports.

## Maintenance

The only maintenance required by the Clarius Cart is to clean it. For cleaning instructions, see *Cleaning the Clarius Cart* on page 40.

If your Clarius Cart requires servicing, contact your Hologic representative.

## Troubleshooting

### ▼The power does not turn on:

The DC power connector may not be fully plugged into the Clarius Cart. Slide the rectangular portion of the DC power connector away from the metallic barrel and re-insert it into the DC jack on the Clarius Cart.

- The DC power connector fits only one way. Ensure that the rectangular side (with the arrows) is facing up.
- The DC power connector fits tight, so you may need to gently wiggle it into the Clarius Cart until you hear a faint click.

## Clarius Battery Charger Hub

The Clarius Battery Charger Hub is a separate accessory that you can purchase for your Clarius Ultrasound Scanner. The charger hub combines a battery charger that can charge up to five batteries and a USB charger that can charge two smart devices (smart phones and tablets).

An external power supply is used to connect the Clarius Battery Charger Hub to the AC wall outlet using the supplied power cord.

The Clarius Battery Charger Hub is designed for use in professional healthcare facilities. The device is not intended to contact the patient during normal use. It is not to be used in emergency medical services environments including during patient transport or the home healthcare environment. The Clarius Battery Charger Hub can be used as a stand-alone portable device, or it can be used while attached to the Clarius Cart. It is not to be placed within 1.5m of the examination table or patient bed.

The Clarius Battery Charger Hub is designed to be used with the Viera™ Rechargeable Li-ion Battery.



## Parts

The Clarius Battery Charger Hub is made up of the following parts:

- A fully-assembled Clarius Battery Charger Hub (CIDN 50-02-00039).
- A power supply (CIDN 50-02-00024) with a cord that is compatible with your country's socket and voltage.

Clean the Clarius Battery Charger Hub before using it. For cleaning instructions, see *Cleaning the Clarius Battery Charger Hub* on page 41.

## Technical Specifications

- Input: 12 VDC, 11.5 A
- Output: 8.4 VDC, 1.5 A x 5 (charger), 5.0 VDC, 2.3 A x 2 (USB)
- Protection Against Electric Shock: Class II
- Applied Part: None
- Ingress Protection: IP00
- Mode of Operation: Continuous

## System Specifications

	Operating Limits	Transportation & Storage Limits
Pressure	620 hPa to 1060 hPa (3,954 m to -38 m)	n/a
Humidity	15% to 95%	0% to 95%
Temperature	10°C (50°F) to 40°C (113°F)	-20°C (-4°F) to 50°C (122°F)

## Setting up

▼To use the Clarius Battery Charger Hub:

1. Clean and disinfect the scanners before placing them in the Clarius Battery Charger Hub.

For cleaning instructions, see *Cleaning the Viera™ Portable Breast Ultrasound* on page 39. For disinfecting instructions, see *Disinfecting the Viera™ Portable Breast Ultrasound* on page 41.

2. Insert the DC power connector into the Clarius Battery Charger Hub.
3. Connect the AC power cord to the power supply.
4. Insert the AC Male Plug into a power source.

The Clarius Battery Charger Hub is now ready to use.



- Do not place the Clarius Battery Charger Hub within 1.5m of the examination table/patient bed.
- Do not touch the patient and the Clarius Battery Charger Hub at the same time.
- If the AC power cord is damaged, contact Clarius for a replacement.

## Using the Clarius Battery Charger Hub

### Charging the Battery

▼To charge the scanner battery:

1. Remove the battery from the scanner.
2. Insert the battery into one of the battery slots. There will be a click when the battery is fully inserted.

If you are having problems inserting the battery, start by placing the battery in the charging slot, press down on the battery edge closest to the front of the Clarius Battery Charger Hub then roll the battery towards the back until you hear the click.

It takes approximately 1 ½ hours for an empty battery to fully charge.

Each charger displays the following status lights:

- Orange: Battery is currently charging.
- Green: Battery is fully charged.
- Off: No battery installed, battery not inserted fully, no power connected, or a problem with the battery.



Do not touch battery charger contacts. Only charge Clarius Rechargeable Li-ion Battery (CIDN 99-02-00001)Viera™ Rechargeable Li-ion Battery.

### Charging the Smart Device

The Clarius Battery Charger Hub can charge any smart device that is used with the Clarius Ultrasound Scanners.

**▼To charge your smart devices:**

1. Connect the smart device's charging cable to the smart device as described in the smart device's user manual.
2. Connect the opposite end of the charging cable to one of the two USB Type-A ports on the back of the Clarius Battery Charger Hub. Charge status will be indicated on the smart device.



Do not touch the patient while touching the USB ports. Do not touch the patient with any device connected to the USB ports.

## Maintenance

The only maintenance required by the Clarius Battery Charger Hub is to clean it. For cleaning instructions, see *Cleaning the Clarius Battery Charger Hub* on page 41.

If your Clarius Battery Charger Hub requires servicing, go to [www.clarius.com/contact](http://www.clarius.com/contact) and contact Clarius.

## Troubleshooting

**▼The power does not turn on:**

The DC power connector may not be fully plugged into the Clarius Battery Charger Hub. Slide the rectangular portion of the DC power connector away from the metallic barrel and re-insert it into the DC jack on the Clarius Battery Charger Hub.

- The DC power connector fits only one way. Ensure that the rectangular side (with the arrows) is facing up.
- The DC power connector fits tight, so you may need to gently wiggle it into the Clarius Battery Charger Hub until you hear a faint click.

## Clarius Fan

The Clarius Fan attaches to the built-in heatsink of the Viera™ Portable Breast Ultrasound. Use the Clarius Fan to extend scanning time.

Fans are designed differently for different scanners. Use only fans that match your scanner type.

**▼To attach the Clarius Fan:**

1. Align the prongs of the fan with the outlet on the heatsink of the Viera™ Portable Breast Ultrasound.
2. Insert the prongs into the outlet and press until it snaps into place.

Make sure that the prongs are plugged in all the way.

When the Viera™ Portable Breast Ultrasound reaches a temperature of 35°C (95°F), the fan automatically activates.

Clean and disinfect the Clarius Fan after each use. For cleaning instructions, see *Cleaning the Clarius Fan* on page 41. For disinfecting instructions, see *Disinfecting the Clarius Fan* on page 43.

# Cleaning & Disinfecting

# 4

It is important to clean and disinfect the Viera™ Portable Breast Ultrasound immediately after use. This chapter will guide you through the cleaning and disinfecting process.

The classification of cleaning and disinfecting you select will depend on the type of tissue the Viera™ Scanner comes into contact with. To find the correct classification, refer to *Spaulding Classification* on page 44.

All compatible accessories may be cleaned using CaviWipes. For a full list of accessories that are compatible with the system, visit <https://clarius.com/products/accessories>.

When cleaning and disinfecting:

- Follow the procedures in the order they are described in this guide, without skipping steps.
- Use only solutions approved by Clarius Mobile Health. Other solutions may be incompatible with the system and could damage the scanner.
- Follow the manufacturer's instructions, recommendations, and guidelines for cleaners and disinfectants, as well as your regional regulations.
- Check expiry dates, concentration, and efficacy of the chemicals used.
- Wear the appropriate personal protective equipment (PPE), such as eyewear and gloves, as recommended by the chemical manufacturer.



- Due to repeated use and cleaning, the cleanliness and sterility of the hardware deteriorates over its service life (five years for the scanner, fan, and Clarius Cart).
- Using incompatible solutions to clean the scanner may damage its surface.
- The scanner and its parts (including accessories) may not withstand the cleaning or disinfecting processes (including repetitive process) specified in this manual, and may damage or deteriorate its safety provisions.
- Cleaning or disinfecting the scanner while the battery is installed may cause the battery to short-circuit and overheat, causing an electric shock or burn.
- Cleaning or disinfecting the scanner using IPA (isopropyl alcohol) may damage it.

During an emergency where the scanner is used to examine multiple patients in a short period of time, the lack of proper cleaning and disinfecting between patients may spread infections to other patients and users.

## Cleaning

### Cleaning the Viera™ Portable Breast Ultrasound

Before cleaning, visually inspect the scanner to determine that it is free of any unacceptable deterioration, such as corrosion, discoloration, pitting, or cracked seals. If damage is evident, discontinue use and contact Hologic Technical Support.

Cleaning the scanner requires that you select the proper cleaning level. Before you begin, determine the level of cleaning by referring to *Spaulding Classification* on page 44. Once you have determined the level, have the cleaning solution ready and follow the procedure below.

#### ▼To clean the Viera™ Portable Breast Ultrasound:

1. Make sure the Viera™ Portable Breast Ultrasound is turned off.
2. Remove the battery and fan from the scanner.



It is important that you clean the two pieces separately.

3. To clean the scanner, dampen a soft cloth using a compatible cleaner. Alternatively, use a premoistened disinfectant wipe.

For a list of compatible cleaners, see *Cleaners & Disinfectants* on page 76.

4. Start at the top of the scanner and wipe toward the scan head. Be sure to remove any gels or particulate matter.
5. Clean the heat sink (the grooves along the body of the scanner) using a thin, disposable instrument, such as a swab, to push a soft cloth lightly dampened with a cleaning solution (or use a premoistened wipe) across the slot. Move the cloth back and forth from one side of the heat sink to the other.
6. Dispose the cloth and the instrument used to insert the cloth.
7. Verify that all gel, particulate matter, and bodily fluids have been removed.
8. Repeat with new cleaning material if necessary.
9. To clean the battery, dampen another soft cloth using a compatible cleaner or disinfectant. Alternatively, use a premoistened disinfectant wipe.
10. Remove all gel, particulate matter, and bodily fluids from the battery.
11. Repeat with new cleaning material if necessary.

When you are done, keep the two parts separate. You will be disinfecting them individually. For disinfecting instructions, see *Disinfecting the Viera™ Portable Breast Ultrasound* on page 41.



Due to particulate matter (for example, biological agents, ultrasound gel, and dirt) in the scanner crevasses, openings, and/or cavities, there is the possibility that the scanner is not cleaned easily or correctly.

## Cleaning the Clarius Cart

▼To clean the Clarius Cart:

1. Unplug the DC power connector from the Clarius Cart.
2. Wipe down all surfaces using a premoistened disinfectant wipe.

For a list of compatible cleaners, see *Cleaners & Disinfectants* on page 76.

3. Repeat with new cleaning material if necessary.
4. Air-dry the Clarius Cart.

Alternatively, towel-dry with a clean, non-linting cloth.

## Cleaning the Clarius Battery Charger Hub

▼To clean the Clarius Battery Charger Hub:

1. Unplug the DC power connector from the Clarius Battery Charger Hub.
2. Wipe down all surfaces using a premoistened disinfectant wipe.

For a list of compatible cleaners, see *Cleaners & Disinfectants* on page 76.

3. Repeat with new cleaning material if necessary.
4. Air-dry the Clarius Battery Charger Hub.

Alternatively, towel-dry with a clean, non-linting cloth.

## Cleaning the Clarius Fan

▼To clean the Clarius Fan:

1. Remove the fan from the Viera™ Portable Breast Ultrasound.
2. Wipe down all surfaces using a premoistened disinfectant wipe.

For a list of compatible cleaners, see *Cleaners & Disinfectants* on page 76.

3. Repeat with new cleaning material if necessary.
4. Air-dry the fan.

Alternatively, towel-dry with a clean, non-linting cloth.

When you are done, keep the two parts separate. You will be disinfecting them individually.

## Disinfecting

### Disinfecting the Viera™ Portable Breast Ultrasound

Before you begin disinfecting, make sure you have cleaned the scanner (see *Cleaning* on page 39).

Disinfecting requires that you choose the proper disinfecting level. Determine the necessary disinfection level by referring to *Spaulding Classification* on page 44. Once you have determined the required disinfecting level, have the disinfectant ready and follow one of the



appropriate procedures below. Note that different levels of disinfection require different steps, not just different solutions.

## Intermediate Disinfection

Refer to *Cleaners & Disinfectants* on page 76 for a list of disinfectants recommended for intermediate disinfection of the scanner.

If the scanner has come into contact with broken skin, mucosal membranes, or blood, it is classified as semi-critical, and you must perform a high-level disinfection. See *High-Level Disinfection* on page 42 for steps.

1. Make sure the battery and fan are still detached from the scanner.



It is important that you disinfect the two pieces individually.

2. Disinfect the scanner by wiping with a cloth moistened with a compatible disinfectant. Alternatively, use a premoistened disinfectant wipe.
3. Disinfect the heat sink (the grooves along the body of the scanner) using a thin, disposable instrument, such as a swab, to push a soft cloth lightly dampened with a disinfectant (or use a premoistened wipe) across the slot. Move the cloth back and forth from one side of the slot to the other.
4. Remove the disinfecting wipe from the slot.
5. Air-dry. Alternatively, towel-dry with a clean, non-linting cloth.
6. Examine the scanner for damage, such as cracks or splitting where fluid can enter. If damage is evident, do not use the scanner and contact Hologic Technical Support.
7. Disinfect the battery and the battery connector by wiping with a cloth moistened with a compatible disinfectant. Alternatively, use a premoistened disinfectant wipe.



The battery connector is delicate. Handle gently.

8. Air-dry. Alternatively, towel-dry with a clean, non-linting cloth.
9. Examine the battery for damage, such as cracks or splitting where fluid can enter. If damage is evident, do not use the battery and contact Hologic Technical Support.

## High-Level Disinfection

Refer to *Cleaners & Disinfectants* on page 76 for a list of disinfectants recommended for high-level disinfection of the scanner.

1. Make sure the battery is still detached from the scanner.



It is important that you disinfect the two pieces individually.

2. Mix the disinfectant solution by following the disinfectant label instructions for solution strength and disinfectant contact duration.
3. Using a compatible disinfectant at a temperature of 23°C (73°F), immerse the scanner and the battery in the disinfectant solution for 45 minutes.



If the battery has been recently used or charged, wait 30 seconds before submersing it in any liquid.



It is important that you immerse the two pieces individually, detached from each other.

4. Using the instructions on the disinfectant label, rinse both the scanner and the battery.
5. Air-dry both pieces. Alternatively, towel-dry with a clean, non-linting cloth.
6. Examine the parts for damage, such as cracks or splitting where fluid can enter. If damage is evident, discontinue use of the scanner and/or battery, and contact Hologic Technical Support.

## Disinfecting the Clarius Fan

Before you begin disinfecting, make sure you have cleaned the fan (see *Cleaning the Clarius Fan* on page 41).

Because the fan cannot be submerged in liquid, you must always use intermediate-level disinfection. Refer to *Cleaners & Disinfectants* on page 76 for a list of disinfectants recommended for intermediate disinfection of the fan.

1. Make sure that the fan is detached from the scanner.



It is important that you disinfect the two pieces individually.

2. Disinfect the fan by wiping with a cloth moistened with a compatible disinfectant. Alternatively, use a premoistened disinfectant wipe.
3. Air-dry. Alternatively, towel-dry with a clean, non-linting cloth.
4. Examine the fan for damage, such as cracks or splitting. If damage is evident, do not use the fan and contact Hologic Technical Support.

## Spaulding Classification

The level of cleaning and disinfecting required for your Viera™ Portable Breast Ultrasound is based on the Spaulding classification system. Following the correct classification will help reduce cross-contamination and infection.

Each Spaulding classification mandates a specific level of cleaning and disinfecting of the equipment before it can be used in the next exam. Determine the Spaulding classification based on your scanner's usage.

<b>Class</b>	<b>Use</b>	<b>Method</b>
Non-Critical Class	Touches intact skin	Cleaning followed by intermediate disinfection
Semi-Critical Class	Touches mucous membranes and non-intact skin	Cleaning followed by high-level disinfection (HLD)

# Safety

# 5

This chapter provides instructions on the product's safe usage and offers information on safety guidelines. Pay special attention to warnings and cautions, and follow them before, during, and after operating the product:

- Warnings indicate information vital to the safety of you, the operator, and the patient.
- Cautions highlight possible damages to the product that may void your warranty or service contract, or lose patient or system data.

## About Diagnostic Ultrasounds

### Interactions with Matter

When using diagnostic ultrasound, the sound waves are directed towards an area of interest, which then interacts with any matter along its path. This interaction is determined by the characteristics of the ultrasound wave, as well as the physical properties of the matter through which the sound wave passes. Diagnostic ultrasound frequencies range from 2 MHz to 15 MHz.

### Studies

Exposure-effect studies have been performed at intensity levels much higher than those in diagnostic ultrasound practice, which revealed two mechanisms known to alter biological systems:

- Thermal mechanism: Heating of soft tissue and bone.
- Non-thermal mechanism: Mechanical phenomena, such as cavitation.

These mechanisms are discussed later.

## Benefits & Risks

Ultrasound is widely used because it provides many clinical benefits to the patient and has an outstanding safety record. In more than three decades of use, there has been no known long-term negative side-effects associated to this technology.

More questions of safety are being discussed because more applications are being discovered, and the industry is producing technically sophisticated scanners that provide more diagnostic information. Dialogue among the medical community, manufacturers, and the FDA has resulted in a standard that allows higher outputs for greater diagnostic capability.

Ultrasound benefits:

- Multiple diagnostic uses
- Immediate results with high-quality information
- Replacement or complimentary or used with other procedures
- Cost-effectiveness
- Portability
- Patient acceptance
- Safety record

Ultrasound risks:

The potential for adverse bioeffects caused by heating or cavitation.

“... the benefits to patients of the prudent use of diagnostic ultrasound outweigh the risks, if any, that may be present.”-- AIUM

## Safety Topics

Use the Viera™ Portable Breast Ultrasound only if you have read and understood all the information in this section. Operating the system without proper safety awareness could lead to fatal or serious personal injury.

This section covers general safety information. Safety information applicable to specific tasks are noted in the procedure. The Viera™ Portable Breast Ultrasound is intended for use by a trained medical professional, or by the direction and supervision of a licensed physician qualified to instruct its usage.

“Diagnostic ultrasound is recognized as a safe, effective, and highly flexible imaging modality capable of providing clinically relevant information about most parts of the body in a rapid and cost-effective fashion.” -- WHO (World Health Organization)

## Product Safety

Hologic is responsible for the safety of the scanners. The safety of your smart device is your responsibility. Always follow the safety guidelines provided with your smart device before, during, and after use.

### Product Warnings



The following actions may cause fatal or other serious injury:

- Using the system or the Clarius Cart without adequate training on its safe and effective operation. If you are unsure of your ability to operate the system safely and effectively, do not use it.
- Attempting to remove, modify, override, or frustrate any safety provisions on the system or the Clarius Cart.
- Using the system or the Clarius Cart with any product that Clarius does not recognize as compatible with the system, or operate the product for unintended purposes.



- If the system and scanner, or Clarius Cart appears to be malfunctioning, stop use immediately. Please contact Hologic Technical Support.
- To avoid exposing you and the patient to safety hazards, if any part of the system or the Clarius Cart is known or suspected to be defective or incorrectly adjusted, do not use the system until it is repaired.
- To avoid compromising the effectiveness of the system and the safety of the patient, the user, and others, do not operate the system with patients unless you have an adequate understanding of its capabilities and functions.
- Configure your smart device in compliance with your institution's security policies. For example, notifications and alerts from third-party applications may interfere with an exam.



- Selecting an incorrect or hazardous imaging mode may deliver excessive acoustic energy to the patient during the exam.
- Heat dissipates through the heatsink and the metal portion of the scanner enclosure. Do not touch these parts or apply them against the patient for longer than one minute. Hold the scanner using the black rubber handle.

## Product Compatibility

The Viera™ Portable Breast Ultrasound comes with a battery, a battery charger, and a power supply for the charger. Do not use your system or the Clarius Cart in combination with other products or components not made by Clarius, unless Clarius expressly recognizes those other products or components as compatible.

Changes and additions to the system can be made only by Clarius or by third parties expressly authorized by Clarius to do so. Such changes and additions must comply with all applicable laws and regulations that have the force of law within the jurisdictions concerned, and best engineering practices. System changes and additions that are made without the appropriate training or by using unapproved spare parts may carry risks of system damage and personal injury.

## Battery Safety



If the battery fails to charge fully, replace it.

- Keep the battery away from heat sources. For example, do not charge the battery near a fire or heater.
- Do not discard the battery in fire.
- Do not open, crush, puncture, or short-circuit contacts.
- If the battery leaks or emits an odor, remove it from the scanner and contact Hologic Technical Support.
- If the battery emits an odor or heat, is deformed or discolored, or in any way appears abnormal during use, recharging or storage, immediately remove it and stop using it. If you have any questions about the battery, please contact Hologic Technical Support.
- If the battery is to remain unused for over a month, keep the charge level between 40% and 50% to prolong its life, and store it in temperatures between -20°C (-4°F) and 20°C (68°F).



The following actions may damage the battery:

- Returning a battery without instructions from Hologic Technical Support.
- Short-circuiting the battery by connecting the positive and negative terminals directly to metal objects.
- Using the battery in temperatures below -20°C (-4°F) or above 60°C (140°F).
- Charging the battery in temperatures below 10°C (50°F) or above 45°C (113°F).
- Forcing the battery into the system. The polarity of the battery terminals is fixed and cannot be reversed.
- Connecting the battery to an electrical power outlet.
- Charging the battery using non-Clarius equipment. Always charge the battery using the battery charger provided by Clarius.

- Touching battery contacts.
- Leaving the battery in direct sunlight.

## Cleaning Safety

It is important to clean and maintain the ultrasound system and peripherals, as well as the Clarius Cart. Thorough cleaning is particularly important for pieces of peripheral equipment, because they contain electromechanical parts. If exposed to constant and excessive sunlight and humidity, the scanner will suffer in both performance and reliability.

It is your responsibility to clean and disinfect your scanner and Clarius Cart in accordance with the cleaning and disinfecting instructions in this manual. For instructions on cleaning and disinfecting the Viera™ Portable Breast Ultrasound, refer to *Cleaning* on page 39.

### Cleaners & Disinfectants



- Use only cleaners and disinfectants recommended by Clarius. Avoid acetone, Methyl ethyl ketone (MEK), paint thinner, or other strong solvents and abrasive cleaners.
- Always use protective eyewear and gloves when cleaning and disinfecting equipment.
- Disinfectants are recommended based on their chemical compatibility (not their biological effectiveness) with product materials. For the biological effectiveness of a disinfectant, see the guidelines and recommendations of the disinfectant manufacturer, the U.S. Food and Drug Administration, and the U.S. Centers for Disease Control.
- If a pre-mixed solution is used, check the expiry date.
- The level of disinfection required for a scanner is determined by the type of tissue it contacts. Ensure the disinfectant is appropriate for the scanner and its application. Also, read the disinfectant label instructions and the recommendations of the Association for Professionals in Infection Control, the U.S. Food and Drug Administration, and the U.S. Centers for Disease Control.
- Clean the scanner and the Clarius Cart after each use. This is an essential step before disinfection.
- When disinfecting the scanner or the Clarius Cart, ensure that the solution's strength and duration of contact are appropriate for disinfection.
- Selecting a non-recommended solution, using an incorrect solution strength, or immersing a scanner deeper or longer than recommended can damage the scanner and will void warranty.
- Follow the manufacturer's recommendations and instructions when using cleaners and disinfectants.

### Minimizing the Effects of Residual Disinfectant

If you use an OPA-based disinfectant, residual solution may remain on your scanners or your Clarius Cart if you do not carefully follow the manufacturer's instructions.



To minimize the effects from residual OPA, or any other disinfectant, Clarius recommends the following:

- Follow the disinfectant manufacturer's instructions very carefully.
- Limit the time that scanners are soaked in the disinfectant solution to the minimum time recommended by the disinfectant manufacturer.

### Factors Affecting Disinfectant Efficacy

The following factors will affect the efficacy of a disinfectant solution:

- Number and location of microorganisms
- Innate resistance of microorganisms
- Concentration and potency of disinfectants
- Physical and chemical factors
- Organic and inorganic matter
- Duration of exposure
- Biofilms

### Scanner Care

Lint, dust, and light (including sunlight) have no effect on the scanner's basic safety and essential performance.



- Avoid sharp objects, such as scissors, scalpels, or cauterizing knives, from touching the scanners.
- Avoid bumping the scanner on hard surfaces.
- Avoid surgeon's brushes when cleaning scanners. Even soft brushes can damage scanners.
- Before storing scanners, make sure they are completely dry. If it is necessary to dry the scanner lens or acoustic window, apply a soft cloth to the area, and blot rather than wipe.
- Use only liquid solutions to disinfect scanners.
- Regularly check the lens of the scanner's acoustic window for degradation, as described in *Cleaning* on page 39, to prevent degradation of image quality and abrasions to the patient's skin.



The following actions may damage your scanner:

- Cleaning or disinfecting a scanner using methods unapproved by Clarius.
- Using paper or abrasive products. They damage the soft lens of the scanner's acoustic window. If the lens is damaged to the point that the scanner elements are exposed, stop using the scanner. Please contact Hologic Technical Support immediately. Exposed scanner elements may cause burns or electric shock to the patient.

- Soaking the scanner for extended periods. Use soaking time and depth recommended by the disinfectant manufacturer.

### Caring for Your Clarius Cart



- Before storing the Clarius Cart, make sure it is completely dry.
- Use only liquid solutions to disinfect the Clarius Cart.
- Cleaning or disinfecting a Clarius Cart using methods unapproved by Clarius may damage it.

## Clinical Safety

### Syringe Safety



- If the needle is not visible, do not perform the needle procedure.
- Verify the location of the needle tip in the image. The Viera™ Portable Breast Ultrasound cannot visualize a needle that is out of plane.
- Thin needles can bend when entering tissue. Verify the needle's position by identifying the echoes from the needle.
- Make sure you are not using a false needle image to locate the needle. False needle images caused by reverberation or other tissue artifacts can misguide you.

### Defibrillator Safety

If you are using the Viera™ Portable Breast Ultrasound and defibrillation is required, use defibrillators that do not have grounded patient circuits. To determine whether a defibrillator patient circuit is grounded, see the defibrillator service guide, or consult a biomedical engineer.

Before defibrillation, remove any part of the system that is in contact with the patient.

## Biological Safety



- Do not use a system that exhibits erratic or inconsistent image updates. This indicates a hardware failure that must be corrected before continuing use.
- Follow the ALARA (as low as reasonably achievable) principle.
- Perform ultrasound procedures prudently. Use the ALARA (as low as reasonably achievable) principle. For information on ALARA, see *ALARA Principle* on page 54.

## Latex

The Viera™ Portable Breast Ultrasounds do not contain natural rubber latex.

Sheaths and biopsy guides you select to use with the Viera™ Portable Breast Ultrasound may contain latex. Check with the manufacturer's safety information.

The following are FDA recommendations on latex awareness:

- When taking general histories of patients, include questions about latex sensitivity. For surgical and radiology patients, spina bifida patients and health care workers, this recommendation is especially important. Questions about itching, rashes, or wheezing after wearing latex gloves or inflating a toy balloon may be useful. For patients with positive histories, flag their charts.
- If latex sensitivity is suspected, consider wearing a non-latex glove over the latex glove if the patient is sensitive. If both the health professional and the patient are sensitive, a latex middle glove could be used. (Latex gloves labeled "Hypoallergenic" may not always prevent adverse reactions.)
- Whenever latex comes in contact with mucous membranes, be alert to the possibility of an allergic reaction.
- If an allergic reaction does occur and latex is suspected, advise the patient of a possible latex sensitivity and consider an immunologic evaluation.
- Advise the patient to tell health professionals and emergency personnel about any known latex sensitivity before undergoing medical procedures. Consider advising patients with severe latex sensitivity to wear a medical identification bracelet.

## Bioeffects

### Thermal

Thermal bioeffects refers to heat generated whenever ultrasound energy is absorbed. The amount of heat produced depends on the ultrasound's intensity, exposure time, and the tissue's absorption characteristics.

Tissue absorbs ultrasound energy to varying degrees depending on the tissue's absorption characteristics. Absorption characteristics are quantified by the absorption coefficient:

- Fluids: Their absorption coefficient is almost zero. Fluids such as amniotic fluid, blood, and urine absorb very little ultrasonic energy. That means the ultrasound goes through the fluid with very little decrease. And there's little temperature elevation in the fluid.
- Bone: Its absorption coefficient is very high. Dense bone absorbs the energy very quickly and causes the temperature to rise rapidly. Adult bone absorbs nearly all acoustic energy impinging on it. Fetal bone absorption coefficients vary greatly depending on the degree of ossification.
- Soft tissue: Soft tissue varies in density depending on the organ, but the density does not vary much within an organ. We call it soft tissue to distinguish it from hard tissue such as

bone. Also, the tissue density within a particular organ is not always the same. But for our purposes, we assume that attenuation is uniform throughout the organ. We call this a homogeneous soft tissue model.

Attenuation is caused by:

- Absorption: Energy converted to heat.
- Scattering: Redirection of ultrasound.

### Mechanical (Non-Thermal)

Mechanical bioeffects are threshold phenomena, such as cavitation, that occur when the output exceeds a certain level. This threshold varies by tissue type.

Cavitation is the interaction of ultrasound with gas bubbles, causing rapid and potentially large changes in bubble size. These bubbles originate within materials at locations termed nucleation sites, the exact nature and source of which are not well understood in a complex medium such as tissue or blood. The change in bubble size may increase temperature and pressure within the bubble, causing mechanical stress on surrounding tissues, precipitate fluid microjet formation, and generate free radicals. Gas-containing structures, such as lungs, are most susceptible to the effects of acoustic cavitation; however, such higher frequency ultrasounds do not provide sufficient time for significant bubble growth; therefore, cavitation is unlikely to occur under these circumstances. Factors that produce cavitation include: pressure (compressional, rarefactional), frequency, focused/unfocused beam, pulsed/continuous waves, degree of standing waves, boundaries, and the nature and state of material.

Scientific evidence suggests that the onset of transient cavitation is a threshold phenomenon. There's a combination of rarefactional pressure values, ultrasonic frequency, and cavitation nuclei that are required for inertial cavitation to occur. If inertial cavitation is a threshold phenomenon, then exposure to pressure levels below the threshold will never induce such events, regardless of the length of exposure.

There are two categories of cavitation:

- Stable: Stable cavitation is associated with vibrating gas bodies. In stable cavitation, a gas body oscillates or pulsates continuously around its equilibrium size. As the oscillations become established, the liquid-like medium around the gas body begins to flow or stream; we call this microstreaming. Microstreaming has been shown to produce stress sufficient to disrupt cell membranes.
- Inertial: During inertial (transient) cavitation, pre-existing bubbles or cavitation nuclei expand because of the rarefactional pressure of the ultrasonic field and then collapse in a violent implosion. The whole process takes place in a time span on the order of microseconds. The implosion can produce huge local temperature rises that may be thousands of degrees Celsius and pressures equal to hundreds of atmospheres, all in a volume of less than  $1 \mu\text{m}^3$ . The implosion can damage cells and tissue, ultimately leading to cell death. In addition, bubble implosion can generate highly reactive chemical species. All of these effects, microstreaming, implosion, and generation of reactive chemicals, occur in a very small space around the bubble, affecting only a few cells.

Exposure of the lung can produce small, localized hemorrhages under some conditions in laboratory animals. These lesions resolve naturally and are without lasting effects in normal subjects, but their possible significance in compromised individuals has not been studied.

## ALARA Principle

The guiding principle for the use of diagnostic ultrasound is defined by the ALARA (as low as reasonably achievable) principle. The threshold for diagnostic ultrasound bioeffects is undetermined, and the definition of “reasonable” is left to the judgment and insight of qualified personnel. No set of rules can be formulated that would be sufficiently complete to dictate the correct response to every circumstance. By keeping ultrasound exposure as low as reasonably achievable as you obtain diagnostic images, you can minimize ultrasonic bioeffects.

Output display indices are designed to provide more quality information, to help guide the sonographers using ultrasound technology, in applying the ALARA principle. Some variables that affect the way output display indices can be used to implement the ALARA principle:

- index values
- body size
- location of the bone relative to the focal point
- attenuation in the body
- ultrasound exposure time (an especially useful variable, as it is controlled by the user)

## Applying ALARA

The system's imaging mode you select depends on the information needed. Understanding the nature of the imaging mode used, the scanner frequency, system setup values, scanning techniques, exposure time, system and scanner capabilities, and operator experience allows the sonographer to apply the ALARA principle with informed judgment and meet the definition of the ALARA principle.

The amount of acoustic output is up to the system operator. This decision must be based on the following factors: type of patient, type of exam, patient history, ease or difficulty of obtaining diagnostically useful information, and the potential localized heating of the patient due to scanner surface temperatures. The objective is to limit patient exposure to the lowest index reading for the shortest amount of time achieving acceptable diagnostic results.

A high index reading does not necessarily indicate the occurrence of a bioeffect, however, it must be taken seriously. It is your responsibility to make every effort to reduce the possible effects of a high index reading by limiting exposure time.

System controls (direct, indirect, and receiver) can be used to adjust the image quality and limit the acoustic intensity, and are related to the techniques that an operator could use to implement ALARA.

## Using System Controls to Implement ALARA

### Direct Controls

The system has no direct control for output, therefore the sonographer must control exposure time and scanning technique to implement the ALARA principle. To ensure that acoustic and thermal limits are not exceeded for all imaging modes, the Viera™ Portable Breast Ultrasound is designed to automatically adjust output.

The system does not exceed a spatial peak temporal average intensity ( $I_{SPTA}$ ) of 720 mW/cm<sup>2</sup> for all imaging modes. The system follows the Output Display Standard (IEC 60601-2-37) and falls within the Track 3 acoustic output limits.

### Indirect Controls

Controls affecting imaging mode, freeze, and depth indirectly affect output. The imaging mode determines the nature of the ultrasound beam. Because freeze stops all ultrasound output but keeps the last image displayed on screen, you can use it to limit exposure time while studying an image and maintaining scanner position during a scan. Some controls, such as depth, show a rough correspondence with output, and may be used as a general means for indirectly reducing MI or TI.

Controls indirectly affecting intensity:

- Pulse repetition frequency: The higher the PRF, the more output pulses per second, increasing the temporal-average intensity.
- Focusing depth: Setting the scanner focus at the proper depth improves the resolution of that structure, without the need to increase intensity to see it better.
- Pulse length: Generally, the longer the pulse, the greater the temporal-average intensity value, which both raises the temperature in the tissue and slightly increases the likelihood for cavitation.
- Dwell time: Scanned modes, such as B-Mode imaging, distribute the energy over a large volume. In scanned modes (equipment keeps the beam stationary), the highest temperature is frequently at the surface where the ultrasound enters the body.

### Receiver Controls

The receiver controls have no output effect. The following receiver controls affect images only:

- Gain or time-gain control (TGC)
- Dynamic range
- Post-processing

## User Responsibility

The various operating modes and output levels mean that more responsibility must be assumed by the users. This is a point that is very often neglected: many assume that if an instrument is “FDA cleared,” then there is no risk of bioeffects. This notion is inaccurate because changing the mode of operation or manipulating controls has the potential to cause major changes in output and hence in exposure. In other words, there is a shift in responsibility for patient safety from the manufacturer to the user.

To obtain good diagnostic information, a high return signal amplitude is needed. This can be attained either by higher output, similar to talking louder, or by higher receiver gain, similar to a hearing aid with a volume control. You must attain the best diagnostic information with minimal exposure to the patient. The threshold at which ultrasound energy causes bioeffects for each individual patient is unknown, therefore, you must get the most information at the lowest possible output level by adjusting the output intensity of the equipment.

As a general guideline:

1. Select the correct scanner frequency and application.
2. Start with a low output level.
3. Optimize the image by using focus, receiver gain, and other imaging controls.
4. If the image is still not diagnostically useful, increase output.

Additional considerations:

- Minimize scan time by performing only medically required ones.
- Use diagnostic ultrasounds efficiently and effectively, as all other medical tools.
- Compromising the exam's quality by rushing the exam could result in a poor exam, which could require follow-up exams, which then adds exposure time.
- Select the appropriate TI and MI range for the task at hand.
- Note that output is affected by frequency, focus, pulse length, and dwell time.

## Output Display

The output display provides the user with an indication of the potential for bioeffects that might be caused by the ultrasound energy being emitted. With this information, users can better control the diagnostic ultrasound equipment and examination to ensure that needed diagnostic information is obtained with a minimum of risk to the patient.

## Display Standards

The system output display consists of the following exposure indices to indicate the potential thermal and mechanical effects:

- TI: This is continuously displayed over the range of 0.0 to maximum output, based on the scanner and application, in increments of 0.1, and consists of the following indices:
  - thermal index for soft tissue (TIS)
  - thermal index for bone (TIB)
  - thermal index for cranial bone (TIC)

Keep output display indices to a minimum. Select a TI based on:

- Approximate index for the application: TIS is used for imaging soft tissue, TIB for a focus at or near bone, and TIC for imaging through bone near the surface (for example, a cranial exam).
  - Mitigating factors that might create artificially high or low TI readings: Location of fluid or bone, or blood flow. For example, is there a highly attenuating tissue path so that the actual potential for local zone heating is less than the TI displays?
  - Scanned modes versus unscanned modes of operation that affect the TI: For scanned modes (such as B-Mode), heating tends to be near the surface. For unscanned modes (such as M-Mode or Doppler-type modes), the potential for heating tends to be deeper in the focal zone.
- MI: This is continuously displayed over the range of 0.0 to 1.9, in increments of 0.1.

### TI Display

The TI indicates any conditions that may lead to temperature increase on the surface of the body, within the body tissue, or at the point of focus of the ultrasound beam on bone. TI informs you of a potential rise in temperature of body tissue, by estimating temperature increases in those body tissue with specific properties. The actual temperature increase is influenced by factors such as tissue type, vascularity, and mode of operation. Use the TI as a guide for implementing the ALARA principle.

You can choose to display one of the following types of TI indices:

- TIS: Indicates potential for heating within soft homogeneous tissue.
- TIB: Indicates potential for heating at or near the focus after the ultrasound beam has passed through soft tissue or fluid. For example, at or near second- or third-trimester fetal bone.
- TIC: Indicates potential for heating of bone at or near the surface. For example, cranial bone.

### MI Display



The higher the MI value, the greater the likelihood of mechanical bioeffects occurring. The potential for mechanical bioeffects varies by peak rarefactional pressure and ultrasound frequency. The MI accounts for these two factors. There is no specific MI value that indicates the occurrence of a mechanical effect. Use the MI as a guide for implementing the ALARA principle.

When interpreting the MI, remember that it is intended to estimate the potential for mechanical bioeffects. The higher the index reading, the greater the potential. However, neither MI = 1 nor any other level indicates that a bioeffect is actually occurring. We should not be alarmed by the reading, but we should use it to implement the ALARA principle.

## Display Accuracy

The MI and TI have a precision of 0.1 unit on the system.

Estimates of the MI and TI display accuracies are shown in the Acoustic Output Tables. The following factors are considered when estimating the accuracy of the displayed values:

- hardware variations

Variability among scanners and systems is a result of piezoelectric crystal efficiencies, process-related impedance differences, and sensitive lens-focusing parameter variations.

- estimation algorithm accuracy

Differences in system pulser voltage control and efficiencies are also contributor to variability. There are inherent uncertainties in the algorithms used to estimate acoustic output values over the range of possible system operating conditions and pulser voltages.

- measurement variability

Inaccuracies in laboratory measurements can be caused by hydrophone calibration and performance, positioning, alignment, and digitization tolerances, and variability among test operators.

## Controls Affecting Display Indices

Use system controls to change the TI and MI values.

### Power Controls

Two real-time output values are on the display: TI and MI. These change as the system responds to power-control adjustments. TI and/or MI values will be displayed whenever the Index values exceeds 0.4 (dimensionless).

### B-Mode Controls

- Focus:

When the focal depth is near the natural focus of the scanner, the MI may be higher.

### Other Control Effects

- B-Mode Depth:

An increase in two-dimensional depth will automatically decrease the B-Mode frame rate, thereby decreasing the TI. The system may also automatically choose a deeper two-dimensional focal depth. A change of focal depth may change the MI. The MI displayed is that of the zone with the largest MI value.

- Application:

Acoustic output defaults are set when you select an application. Factory defaults vary with scanner, application, and mode. Defaults have been chosen below the FDA limits for intended use.

- Imaging Mode Controls:

When a new imaging mode is selected, both the TI and MI may change to default settings. Each mode has a corresponding pulse repetition frequency and maximum intensity point. In combined or simultaneous modes, the TI is the sum of the contribution from the modes enabled, and the displayed MI is the largest of the MI values associated with each mode and focal zone enabled. The system will return to the previously selected state if a mode is turned off and then reselected.

- Scanner:

Each scanner type has unique specifications for contact area, beam shape, and center frequency. Selecting a scanner initializes its default settings, which varies by scanner, application, and selected mode. These defaults are set below the FDA limits for intended use.

### Example of reducing output:

Imagine we are getting ready to do a liver scan. The first thing we need to do is select the appropriate scanner frequency. Next, we adjust the output intensity (or power) transmit setting. We check to make sure that it is positioned at the lowest possible setting to produce an image. We adjust the focus to the area of interest and then increase the receiver gain to produce a uniform representation of the tissue. If we can obtain a good image by increasing the gain, we can lower the output and continue to increase the gain. Only after making these adjustments and if tissue penetration or echo amplitude levels are inadequate should we increase the output to the next higher level.

## Acoustics

The scanner is the most important factor in image quality. Optimal imaging cannot be obtained without the correct scanner. The system is optimized for use based on your scanner selection.

The system limits patient contact temperature to 43°C (109°F), and acoustic output values to their respective U.S. Food and Drug Administration limits. A power-protection circuit protects against over-current conditions. If the power monitor protection circuit senses an over-current condition, then the drive voltage to the scanner is shut off immediately, preventing overheating of the scanner surface and limiting acoustic output. Validation of the power protection circuit is done under normal system operation.

A temperature elevation of less than 1.5°C (2.7°F) is considered harmless to human tissue (including embryo or fetus). Temperatures in excess of this may cause harm, depending on the length of time maintained. A temperature elevation of 4°C (7.2°F), maintained for five minutes or more, is considered to be potentially hazardous to a fetus or embryo.

## Acoustic Artifacts

An acoustic artifact is information, present or absent in an image, which does not properly indicate the structure or flow being imaged. Examples of acoustic artifacts that hinder proper interpretation:

- Added objects displayed as speckle, section thickness, reverberation, mirror image, comet tail, or ring down.
- Missing objects due to poor resolution.
- Incorrect object brightness due to shadowing or enhancement.
- Incorrect object location due to refraction, multi-path reflections, side lobes, grating lobes, speed error, or range ambiguity.
- Incorrect object size due to poor resolution, refraction, or speed error.
- Incorrect object shape due to poor resolution, refraction, or speed error.

## Acoustic Output & Measurement

The acoustic output for this system has been measured and calculated in accordance with the “Acoustic Output Measurement Standard for Diagnostic Ultrasound Equipment” (Revision 3, AIUM, NEMA, 2004), the “Standard for Real-Time Display of Thermal and Mechanical Acoustic Output Indices on Diagnostic Ultrasound Equipment” (Revision 2, AIUM, NEMA, 2004), and the September 2008 FDA document “Information for Manufacturers Seeking Marketing Clearance of Diagnostic Ultrasound Systems and Scanners.”

## In Situ, Derated, & Water Value Intensities

All intensity parameters are measured in water. Because water absorbs very little acoustic energy, these water measurements represent a worst-case value. Biological tissue does absorb acoustic energy. The true value of the intensity at any point depends on the amount and type

of tissue and the frequency of the ultrasound that passes through the tissue. The intensity value in the tissue, in situ, has been estimated by using the following formula:

In situ = Water  $[e^{-(0.23alf)}$ ] Where:

Variable	Value
In Situ	In situ intensity value
Water	Water value intensity
e	2.7183
a	Attenuation factor
Tissue	a(dB/cm-MHz)
Amniotic Fluid	0.006
Brain	0.53
Heart	0.66
Kidney	0.79
Liver	0.43
Muscle	0.55
l	Skin line to measurement depth (cm)
f	Center frequency of the scanner/system/mode combination (MHz)

Because the ultrasonic path during an examination is likely to pass through varying lengths and types of tissue, it is difficult to estimate the true in situ intensity. An attenuation factor of 0.3 is used for general reporting purposes. Therefore, the in situ value which is commonly reported uses the formula:

$$\text{In situ derated} = \text{Water} [e^{-(0.069lf)}]$$

Because this value is not the true in situ intensity, the term “derated” is used.

Mathematical derating of water-based measurements using the 0.3 dB/cm MHz coefficient may yield lower acoustic exposure values than would be measured in a homogenous 0.3 dB/cm MHz tissue. This is true because nonlinearly propagating acoustic energy waveforms experience more distortion, saturation, and absorption in water than in tissue, where attenuation present all along the tissue path will dampen the buildup of nonlinear effects.

The maximum derated and the maximum water values do not always occur at the same operating conditions. Therefore, the reported maximum water and derated values may not be related by the in situ (derated) formula. For example: A multi-zone array scanner that has maximum water value intensities in its deepest zone may have its largest derated intensity in one of its shallowest focal zones.

## Conclusions Regarding Tissue Models & Equipment Survey

Tissue models are necessary to estimate attenuation and acoustic exposure levels in situ from measurements of acoustic output made in water. Presently, available models may be limited in their accuracy because of varying tissue paths during diagnostic ultrasound exposures and uncertainties in acoustical properties of soft tissues. No single tissue model is adequate for predicting exposures in all situations from measurements made in water, and continued improvement and verification of these models is necessary for making exposure assessments for specific applications.

A homogeneous tissue model with an attenuation coefficient of 0.3 dB/cm MHz throughout the beam path is commonly used when estimating exposure levels. The model is conservative in that it overestimates the in situ acoustic exposure when the path between the scanner and the site of interest is composed entirely of soft tissue, because the attenuation coefficient of soft tissue is generally higher than 0.3 dB/cm MHz. When the path contains significant amounts of fluid, as in many first- and second-trimester pregnancies scanned transabdominally, this model may underestimate the in situ acoustical exposure. The amount of underestimation depends on each specific situation. For example, when the beam path is longer than 3 cm and the propagation medium is predominantly fluid (conditions that may exist during transabdominal OB scans), a more accurate value for the derating term is 0.1 dB/cm MHz.

Fixed-path tissue models, in which soft tissue thickness is held constant, sometimes are used to estimate in situ acoustical exposures when the beam path is longer than 3 cm and consists largely of fluid. When this model is used to estimate maximum exposure to the fetus during transabdominal scans, a value of 1 dB/cm MHz may be used during all trimesters.

The maximum acoustic output levels of diagnostic ultrasound scanners extend over a broad range of values:

- A survey of 1990-equipment models yielded MI values between 0.1 and 1 at their highest output settings. Maximum MI values of approximately 2 are known to occur for currently available equipment. Maximum MI values are similar for real-time B-Mode, M-mode, and PW Doppler.
- Computed estimates of upper limits to temperature elevations during transabdominal scans were obtained in a survey of 1988 and 1990 Doppler equipment. The vast majority of models yielded upper limits less than 1°C and 4°C (1.8°F and 7.2°F) for exposures of first-trimester fetal tissue and second-trimester fetal bone, respectively. The largest values obtained were approximately 1.5°C (2.7°F) for first-trimester fetal tissue and 7°C (12.6°F) for second-trimester fetal bone. Estimated maximum temperature elevations given here are for a “fixed-path” tissue model and are for scanners having  $I_{spta}$  (derated) values greater than 500 mW/cm<sup>2</sup>. The temperature elevations for fetal bone and tissue were computed based on calculation procedures given in Sections 4.3.2.1 through 4.3.2.6 in “Bioeffects and Safety of Diagnostic Ultrasound” (AIUM Report, January 28, 1993).

## Acoustic Measurement Precision & Uncertainty

All table entries have been obtained at the same operating conditions that give rise to the maximum index value in the first column of the tables. Measurement precision and

uncertainty for power, pressure, intensity, and center frequency are listed in the following tables.



Measurement precision on the following quantities is determined by making repeated measurements and stating the standard deviation as a percentage.

#### ACOUSTIC MEASUREMENT PRECISION

Quantity	Precision (Percentage Standard Deviation)
Pr is the underated peak rarefactional pressure measured in megapascals (MPa)	Pr: 5.4%
Wo is the ultrasonic power in milliwatts (mW)	6.2%
$f_c$ is the center frequency in megahertz (MHz) (NEMA UD-2 definition)	<1%
PII.3 is the derated spatial-peak pulse intensity integral in joules per square centimeter ( $J/cm^2$ )	PII.3: 3.2%

#### ACOUSTIC MEASUREMENT UNCERTAINTY

Quantity	Measurement Uncertainty (Percentage, 95% Confidence Value)
Pr is the underated peak rarefactional pressure measured in megapascals (MPa)	Pr: $\pm 11.3\%$
Wo is the ultrasonic power in milliwatts (mW)	$\pm 10\%$

## Fire & Electrical Safety

### Fire Safety

Always have fire extinguishers available for both electrical and non-electrical fires.

In the event of an electrical or chemical fire, use only extinguishers that are specifically labeled for such purposes. Using water or other liquids can cause fatal or other serious personal injury. To reduce the risk of electrical shock, try isolating the product, if safe to do so.

Using electrical products in an environment for which they were not designed to be used can lead to fire or explosion. Apply, observe, and enforce appropriate fire regulations for the type of medical area being used.

## Electrical Safety



- To reduce electrical shock hazards, inspect the scanner face and housing, and also the Clarius Cart before use. Discontinue use if the housing is damaged, or if the face is cracked, chipped, or torn.
- All patient-contact scanners not specifically indicated as defibrillation-proof must be removed from the patient before applying high-voltage defibrillation pulse.
- High-frequency electrical signals from an ultrasound can interfere with pacemaker operation. Be alert to this unlikely but potential hazard and stop using the system if you notice it is interfering with a pacemaker.
- Connecting accessories not supplied or approved by Clarius could result in electrical shock.
- Electrosurgical units (ESUs) and other scanners intentionally introduce RF electromagnetic fields (currents) into patients. Because imaging ultrasound frequencies are within the RF range, ultrasound scanner circuits are susceptible to RF interference.
- A burn hazard may result from a surgical equipment with a defect in the high-frequency surgical neutral electrode connection. Do not use scanners with high-frequency surgical equipment.
- Using accessories other than those specified for use with the Viera™ Portable Breast Ultrasound may result in increased emissions of the system.

## Electromagnetic Safety

The Viera™ Portable Breast Ultrasound uses wireless technology to communicate with your smart device. Wireless communication can be affected by severe weather conditions and radio frequency interference. Such environments will not cause the safety of the Viera™ Portable Breast Ultrasound to deteriorate, but the captured image may show signs of unwanted noise and/or artifacts. The technology used in the Viera™ Portable Breast Ultrasound is designed to minimize these affects but may not eliminate them entirely.

## Electromagnetic Compatibility

The Viera™ Portable Breast Ultrasound and the Clarius Cart have been manufactured with existing electromagnetic compatibility requirements and have been tested and found to comply with electromagnetic compatibility standards to provide reasonable protection against harmful interference in a typical medical installation.

Use of this system in the presence of an electromagnetic field can cause momentarily degraded image quality. If this occurs frequently, review the environment surrounding the system and identify possible sources of radiated emissions. These emissions could be caused by other electrical equipment from:

- The same or adjacent room.
- Portable or mobile RF communications equipment (such as cellular phones and pagers).
- Radio, TV, or microwave transmission equipment located nearby.

The scanner's built-in radio operates in the 2.4 GHz and 5 GHz bands, and supports:

- Bluetooth 4.1 as well as CSA2.
- IEEE Std 802.11a, 802.11b/g, and IEEE Std 802.11n data rates with 20 MHz or 40 MHz SISO and 20 MHz MIMO.



Caution:

- Using parts and accessories not recommended by Clarius may result in increased emissions or decreased immunity of the system. Use only accessories and peripherals recommended by Clarius.
- EMC precautions for medical equipment must be followed according to the EMC information provided in that system's accompanying documents.
- The Viera™ Portable Breast Ultrasound's AC power supply cable is limited to 1.5 m (4.9 feet).

### Electrostatic Discharge Precautions

Electrostatic discharge (ESD), or static shock, results from the flow of an electrical charge from a person or object of a higher charge to that of a lower charge. ESD is most prevalent in low-humidity environments, often caused by heating or air-conditioning.



To reduce ESD:

- Use anti-static spray on carpets, linoleum, and mats. Or use a ground wire connection between the system and the patient table or bed.
- Do not touch the connector pins on the battery.
- Do not touch the patient and the Clarius Cart at the same time.

### Electromagnetic Emissions

Ensure that the Viera™ Portable Breast Ultrasound is used only in those operating environments indicated in the following table. Operating the system in an environment that does not meet these conditions may degrade system performance.

#### DECLARATION OF ELECTROMAGNETIC EMISSIONS

Emissions Test	Compliance	Electromagnetic Environment
RF emissions, CISPR 11	Group 1	The system uses RF energy only for its internal function. Therefore, its RF emissions are very low and are not likely to cause any interference in nearby electronic equipment.
RF emissions, CISPR 11	Class A	The system is suitable for use in all establishments, except domestic establishments and those directly connected to the public low-voltage power supply network that supplies buildings used for domestic purposes
Harmonic emissions, IEC 61000-3-2	Class A	
Voltage fluctuations/flicker emissions, IEC 61000-3-3	Complies	



## Electromagnetic Immunity

Immunity Test	IEC 60601-1-2 Test Level	Compliance Level
ESD @ battery mode transmitting and charge mode* EN/IEC 61000-4-2	+/-2kV, +/-4kV, +/-8kV Contact +/-2kV, +/-4kV, +/-8kV, +/-15kV Air	+/-2kV, +/-4kV, +/-8kV contact +/-2kV, +/-4kV, +/-8kV, +/-15kV Air
Radiated, radio frequency electromagnetic field immunity - battery mode transmitting and charge mode (1 kHz 80% AM for ETSI 301 489-1 and -17 @ battery only, 2 Hz modulation for IEC 60601-1-2)* EN/IEC 61000-4-3	3 V/M 2 Hz modulation	3 V/M 2 Hz modulation
Electrical fast transient @ charge mode IEC 61000-4-4	+/-0.5kV, +/-1.0kV	+/-0.5kV, +/-1.0kV
Immunity to surge @ charge mode IEC 61000-4-5	0.5kV, 1.0kV, 2.0kV common mode 0.5kV, 1.0kV differential mode	0.5kV, 1.0kV, 2.0kV common mode 0.5kV, 1.0kV differential mode
Conducted, radio-frequency electromagnetic immunity test @ charge mode (2 Hz modulation) IEC 61000-4-6	3 VRMS-6VRMS in ISM bands 2 Hz modulation	3 VRMS-6VRMS in ISM bands 2 Hz modulation
Power frequency magnetic field immunity test @ battery and charge mode IEC 61000-4-8	30A/M	30A/M
Voltage dips/ interruptions @ charge mode IEC 61000-4-11	0% for 0.5 cycle @ 0°, 45°, 90°, 135°, 180°, 225°, 270°, 315° 0% for 1 cycle @ 0° 70% for 25/30 cycles (50/60 Hz) @ 0° 0% for 250/300 cycles @ 0°	0% for 0.5 cycle @ 0°, 45°, 90°, 135°, 180°, 225°, 270°, 315° 0% for 1 cycle @ 0° 70% for 25/30 cycles (50/60 Hz) @ 0° 0% for 250/300 cycles @ 0°

\*For ETSI 301 489-1 and ETSI 301 489-17: Tested in transmit mode only, no idle mode exists for this product.

## Electromagnetic Interference

The way an electromagnetic interference (EMI) from other equipment affects the Viera™ Portable Breast Ultrasound and the Clarius Cart depends on the system's operation mode, image control settings, and the type and level of electromagnetic phenomena. Electromagnetic phenomena may be intermittent, making it difficult to identify the source.



If you experience EMI, use caution if you continue using the system, or consider relocating your system or your Clarius Cart.

The following table describes typical interferences seen in imaging systems. It is impossible to describe all manifestations of interference, because it depends on many parameters of the transmitting equipment, for example, the type of modulation used by the signal carrier, the source type, and the transmitted level. It is also possible for the interference to degrade the imaging system's performance and become invisible on the image. If the diagnostic results are suspicious, confirm the diagnosis using other methods.

Imaging Mode	ESD <sup>a</sup>	RF <sup>b</sup>	Power Line <sup>c</sup>
B-Mode	Change of operating mode, system settings, or system reset. Brief flashes in the displayed or recorded image.	For sector imaging scanners, white radial bands or flashes in the center lines of the image. For linear imaging scanners, white vertical bands, sometimes more pronounced on the sides of the image.	White dots, dashes, or diagonal lines near the center of the image.

a. Electrostatic discharge caused by discharging of electric charge buildup on insulated surfaces or persons.

b. Radio frequency energy from RF transmitting equipment such as portable phones, hand-held radios, wireless devices, commercial radio and TV stations, and so on.

c. Conducted interference on power lines or connected cables caused by other equipment, such as switching power supplies, electrical controls, and natural phenomena such as lightning.

## Separation Distance

### Recommended Separation Distance

The following table shows recommended separation distances for the system to be kept away from any RF-transmitting equipment. To reduce the risk of interference, when using portable and mobile RF communications equipment, follow the recommended separation distance (calculated from the equation applicable to the frequency of the transmitter). Ensure that field strengths from fixed RF transmitters, as determined by an electromagnetic site survey, are less than the compliance level in each frequency range as noted in the table.

Field strength is difficult to predict theoretically with accuracy if they come from fixed transmitters, such as base stations for radio (cellular/cordless) telephones and land mobile radios, amateur radio, AM and FM radio broadcast, and TV broadcast. To assess the electromagnetic environment from fixed RF transmitters, consider conducting an electromagnetic site survey. If the measured field strength in the location in which the system is used exceeds the applicable RF compliance level in the table, observe the system to verify normal operation. If abnormal performance is observed, apply additional measures, such as reorienting or relocating the system.



At 80 MHz and 800 MHz, the higher frequency range applies.

The recommended separation distance guidelines in the following table may not apply to all situations. Electromagnetic propagation is affected by absorption and reflection from structures, objects, and people.

The table here provides guidance on conducted and radiated interference from portable and fixed RF transmitting equipment.

**RECOMMENDED SEPARATION DISTANCES BY TRANSMITTER FREQUENCY**

Rated Maximum Output Power of Transmitter (Watts)	150 kHz to 80 MHz	80 to 800 MHz	800 MHz to 2.5 GHz
0.01	0.35 m (13.8 in)	0.12 m (4.7 in)	0.23 m (9.1 in)
0.1	1.1 m (3.6 ft)	0.38 m (15 in)	0.73 m (28.7 in)
1	3.5 m (11.5 ft)	1.2 m (3.9 ft)	2.3 m (7.5 ft)
10	11 m (36.1 ft)	3.8 m (12.5 ft)	7.3 m (24 ft)
100	35 m (114.8 ft)	12 m (39.4 ft)	23 m (75.5 ft)

For example, if a portable transmitter has a maximum radiated power of 1 W and an operating frequency of 156 MHz, it can be operated at distances greater than 1.2 m (3.9 ft) from the system. Similarly, a 0.01 W Bluetooth wireless LAN smart device operating at 2.4 GHz should be placed no closer than 0.24 m (9.5 in) from any part of the system.

### Avoiding Electromagnetic Interference

An ultrasound system is designed to receive signals at radio frequencies, making them susceptible to interference generated by RF energy sources. Other examples of interference are medical equipment, information technology products, and radio and television transmission towers.

To locate the source, find out if the problem resides with the system or the scanning environment:

- Is the interference intermittent or constant?
- Does the interference show up only with one scanner or with several scanners?
- Do two different scanners operating at the same frequency have the same problem?
- Is the interference present if the system is moved to a different location in the facility?
- Can the EMC coupling path be attenuated? For example, placement of a scanner or printer close to an ECG cable can increase electromagnetic interference. Moving the cable or other medical equipment away from the location of the scanner or printer can result in reduced electromagnetic interference.

If you find the interference's source, please contact Hologic Technical Support.

### **Regulation of Low-Power Motor for Radio Wave Range**

NCC Warning:

Article 12: Without permission, any company, distributor, or user must not modify the certified low-power radio frequency motor, by changing the frequency, power, or the original design features or functions.

Article 14: The use of low-power radio frequency motor must not affect airplane safety or legal telecommunications. If you discover any danger to airplane safety or interference to legal telecommunications, stop use immediately until the safety is improved or the interference is eliminated.

The legal telecommunication refers to wireless telecommunication under regulations. The low-power radio frequency motor must bear the disturbance from legal telecommunication or industrial, scientific, or medical radio wave device.

(1) Avoidance of operations affecting nearby radar systems.

(2) High-gain directivity antennas must be applied only to fixed point-to-point systems.

# References

# 6

## Compliance Statement

Clarius products comply with international and national standards and laws. Users are responsible for ensuring that the chosen smart device and scanner are compliant with the law in the jurisdiction where the product is used. Clarius meets all regulatory standards listed in this chapter.

## The Viera™ Portable Breast Ultrasound

### Product Classification

Classification:

- Device with scanners (internally powered ME equipment):
  - Health Canada: Class III
  - US FDA: Class II
  - EU: Class IIa
- Scanners: Type BF applied parts, IP67
- Battery: IP67
- Ordinary Equipment/Continuous Operation
- Non-AP/APG

### Product Serial Number

Clarius has assigned a unique serial number on each scanner to track quality control.

Clarius Scanners use the format PT-R-YYMM-zXXXX. We will use the serial number L738-A-1803-A0100 as an example to explain how to interpret this.

#### PT

Scanner type. In our example, this is “L738”.

#### R

Revision. In our example, this is “A”.

#### YY

Two-digit year of manufacture. In our example, this is “18”, meaning the year 2018.

#### MM

Two-digit month of manufacture. In our example, this is “03”, meaning the month of March.

#### z

Alphabetical counter, from A to Z, resetting to A on the first day of each calendar year. In our example, this is “A”.

#### XXXX

Four-digit numerical counter starting from 0001, resetting to 0001 on first day of each calendar year. In our example, this is “0100”, meaning the 100th scanner manufactured in this series.

## System Specifications

The Viera™ Portable Breast Ultrasound conforms to the following specifications:

- Gray shades: 256 in B-Mode
- Scan lines: Up to 1,024 scan lines
- Pressure, humidity, and temperature limits: These limits apply only to the Viera™ Portable Breast Ultrasound, not to the smart device. It is your responsibility to select a Clarius-compatible smart device that meets the needs of your clinical environment.

	Operating Limits	Storage Limits	Transient Operating Conditions <sup>ab</sup>
Pressure	620 hPa to 1060 hPa	n/a	n/a
Humidity	15% to 95%	0% to 95%	15% to 95%.
Temperature	0°C (32°F) to 40°C (104°F)	-20°C (-4°F) to 50°C (122°F)	-20°C (-4°F) to 35°C (95°F)

a. The conditions under which the scanner can operate, for at least 20 minutes, immediately after being removed from an environment of 20°C (60°F).

b. Transient Operating Conditions are applicable in North America only.

To reach an operating temperature of 20°C (68°F), the Viera™ Portable Breast Ultrasound requires approximately 30 minutes to:

- Warm up from a storage temperature of -20°C (-4°F).
- Cool down from a storage temperature of 50°C (122°F).

Maximum scanner surface temperature is:

- Viera™ = 39.4°C

If the scanner reaches its maximum surface temperature, it automatically shuts down.



This icon, when blue, indicates that the scanner is cool. When this icon is red, it indicates that the scanner is warm.

For information on storage temperatures see *Storing Scanners* on page 28.

## Scanner Specifications

Scanner	Clinical Usage	Size	Frequency Range
Viera™ Scanner	breast	38.5 mm	4 – 14 MHz

## Standards

### Biocompatibility

ANSI/ISO 10993-1:2009 - Biological evaluation of medical devices - Part 1: Evaluation and testing within a risk management process.

Medical devices - Biological evaluation - Part 1: Evaluation and testing GB / T 16886.1-2011

GB / T 16886.5-2016 Biological evaluation of medical devices - Part 5: In vitro cytotoxicity test

GB / T 16886.10-2016 Biological evaluation of medical devices - Part 10: Stimulation and delayed hypersensitivity test

## Chemical

REACH 02006R1907:2015-03-23 - REGULATION (EC) No 1907/2006 OF THE EUROPEAN PARLIAMENT AND OF THE COUNCIL of 18 December 2006 concerning the Registration, Evaluation, Authorization and Restriction of Chemicals (REACH), establishing a European Chemicals Agency



The Viera™ Portable Breast Ultrasound meets the minimum requirements for compliance with the European Union's Restriction of Hazardous Substances (RoHS) Directive 2011/65/EU and its amendments.

## Electrical Safety

Reference No.	Year	Title
IEC 61157	2013	Standard means for the reporting of the acoustic output of medical diagnostic ultrasonic equipment
IEC 62133	2012	Secondary cells and batteries containing alkaline or other non-acid electrolyte - Safety requirements for portable sealed secondary cells, and for batteries made from them, for use in portable applications
ST/SG/AC.10/11/Rev.5	2009	Transport of Dangerous Goods.

## Labeling

ISO 60417:2014 - Graphical symbols for use on equipment. See *Symbols Glossary* on page 2.

## Quality

### Performance

Reference No.	Year	Title
AIUM/NEMA UD 2-2004	2009	NEMA Standards Publication UD 2-2004 (R2009) Acoustic Output Measurement Standard For Diagnostic Ultrasound Equipment, Revision 3. (Radiology)
AIUM/NEMA UD 3-2004	2009	NEMA Standards Publication UD 3-2004 (R2009) Standard for Real-Time Display of Thermal and Mechanical Acoustic Output Indices on Diagnostic Ultrasound Equipment



ANSI/AAMI ES60601-1	2005/(R)2012 A1:2012 C1:2009(R)2012 A2:2010(R)2012	Medical electrical equipment-Part 1: General requirements for basic safety and essential performance (IEC 60601-1:2005, MOD)
CAN/CSA-C22.2 No. 60601-1-6:11	2011	Medical electrical equipment - Part 1-6: General requirements for basic safety and essential performance - Collateral standard: Usability (Adopted IEC 60601-1-6:2010, third edition, 2010-01)
CAN/CSA-C22.2 No. 60601-1:14	2014	Medical electrical equipment - Part 1: General requirements for basic safety and essential performance (Adopted IEC 60601-1:2005, third edition, 2005-12, including amendment 1:2012, with Canadian deviations)
IEC 60601-1	2012	Medical electrical equipment - Part 1: General requirements for basic safety and essential performance
GB 9706.1	2007	Medical electrical equipment - Part 1: General requirements for safety
GB 9706.9	2008	Medical electrical equipment - Part 2-37: Particular requirements for the safety of ultrasonic medical diagnostic and monitoring equipment
GB 10152	2009	B-Mode ultrasonic diagnostic equipment
GB/T 14710	2009	Environmental requirement and test methods for medical electrical equipment.
GB/T 16846	2008	Requirements for the declaration of acoustic output of medical diagnostic ultrasonic equipment
GB/T 191	2008	Packaging and pictorial marking for handling of goods
IEC 60601-1-2	2014	Medical electrical equipment - Part 1-2: General requirements for basic safety and essential performance - Collateral Standard: Electromagnetic Capability - Requirements and tests
IEC 60601-1-6	2013	Medical electrical equipment - Part 1-6: General requirements for basic safety and essential performance - Collateral Standard: Usability
IEC 60601-1-12 <sup>a</sup>	2014	Medical electrical equipment - Part 1-12: Requirements for Medical Electrical Equipment and Medical Electrical Systems Intended For Use in the Emergency Medical Services Environment
IEC 60601-2-37	2007	Medical electrical equipment - Part 2-37: Particular requirements for the basic safety and essential performance of ultrasonic medical diagnostic and monitoring equipment
YY 0076	1992	Classification of metal parts coating technology
YY 0505	2012	Medical electrical equipment - Part 1-2: General requirements for safety Collateral standards: EMC requirements and tests
YY 0767	2009	Ultrasound color flow imaging system
YY/T 1420	2016	Environmental requirement and test methods for medical ultrasonic equipment

a. North America only.

## Risk, Product Specification, Design Review, & Verification/Validation

Reference No.	Year	Title
21 CFR 11	2014	Part 11 Electronics Records and Electronic Signatures
21 CFR 801	2014	Part 801 Labeling
21 CFR 820	2014	Part 820 Quality System Regulation
21 CFR 821	2014	Part 821 Medical Device Tracking Requirements
21 CFR 822	2014	Part 822 Postmarket Surveillance
21 CFR 830	2014	Part 830 Unique Device Identification
BS EN 1041	2013	Information supplied by the manufacturer of medical devices - Medical Device Information
CMDR	2011	Canadian Medical Devices Regulations (CMDR): <ul style="list-style-type: none"> <li>• Safety and Effectiveness Requirements (Sections 10-20)</li> <li>• Labeling Requirements (Sections 21-23)</li> </ul>
EN ISO 13485 ISO 13485	2016 2016	Medical Devices - Quality Management Systems - Requirements for Regulatory Purposes
EN ISO 14971 ISO 14971	2012 2007	Medical Devices - Application of Risk Management to Medical Devices
IEC 62304	2006	Medical device software - Software life cycle processes
IEC 62366	2014	Medical devices - Application of usability engineering to medical devices
IEC/TR 80002-3	2014	Medical device software - Part 3: Process reference model of medical device software life cycle processes
IEEE 11073- 20601a	2010	Health informatics - Personal health device communication. Part 20601: Application profile - Optimized Exchange Protocols
ISO 10993-1	2009	Biological evaluation of medical devices - Part 1: Evaluation and testing within a risk management process
ISO 15223-1	2012	Medical devices - Symbols to be used with medical device labels, labeling and information to be supplied
MDD	1993	Medical Device Directive 93/42/EEC ANNEX II
YY/T 0316	2016	Medical Device Risk Management for Medical Device Applications

## Security & Privacy

IEC TR 80002-3:2014 - Medical device software - Part 3: Process reference model of medical device software life cycle processes.

## Wireless

U.S.

- FCC15.247

Europe

- ETSI EN 300 328:2006-05- Electromagnetic compatibility and Radio spectrum Matters (ERM)
- ETSI EN 301 489-1:2008-02- Electromagnetic compatibility and Radio spectrum Matters (ERM)
- ETSI EN 301 489-17:2009-05-Electromagnetic compatibility and Radio spectrum Matters (ERM)

## Cleaners & Disinfectants

### Cleaner & Disinfectant Usage

The following table lists the cleaners and disinfectants compatible with your Viera™ Portable Breast Ultrasound and accessories. The products listed in the following table are chemically compatible and have been tested for efficacy.

Product	Qualified Use <sup>a</sup>	Viera™ Scanner	Clarius Clip-on	Clarius Fan	Clarius Cart	Viera™ Rechargeable Li-ion Battery	Viera™ Battery Charger	Clarius Battery Charger Hub
Accel® PREVENTion™ Wipes	LLD, ILD	✓	✓	✓	✓	✓	✓	✓
Accel® TB Wipes	LLD, ILD	✓	✓	✓	✓	✓	✓	✓
CaviWipes	LLD, ILD	✓	✓	✓	✓	✓	✓	✓
CIDEX® OPA	HLD	✓	✓			✓		
McKesson OPA/ 28 High-Level Disinfectant Solution	HLD	✓	✓			✓		
Sani-Cloth® HB Germicidal Disposable Wipe	LLD, ILD	✓	✓	✓	✓	✓	✓	✓

Sani-Cloth® Plus Germicidal Disposable Cloth	LLD, ILD	✓	✓	✓	✓	✓	✓	✓
Tristel Trio Wipes System	HLD <sup>b</sup>	✓	✓	✓	✓	✓	✓	✓
Virox™ AHP® 5 RTU Wipes	LLD, ILD	✓	✓	✓	✓	✓	✓	✓

- a. CL = Cleaner, HLD = High-level disinfectant, ILD = Intermediate-level disinfectant, LLD = Low-level disinfectant, S = Sterilant  
b. EU only.

You may also use products not specifically listed in the compatibility table but with similar active ingredients, as indicated in this list, and marketed for medical use.

Because of the large number of available cleaners and disinfectants, it is impossible to have an all-inclusive list. If you are unsure of the suitability of a particular product, please contact Hologic Technical Support for more information.

## Cleaner & Disinfectant Details

Solution	Origin <sup>a</sup>	Usage	Active Ingredients
Accel® PREvention™ Wipes	CA	Wipe	Hydrogen Peroxide
Accel® TB Wipes	CA	Wipe	Hydrogen Peroxide
CaviWipes	US	Wipe	Alcohol, Quaternary Ammonia
CIDEX® OPA	US	Soak	Ortho-phthalaldehyde
McKesson OPA/28 High-Level Disinfectant Solution	US	Soak	Ortho-phthalaldehyde
Sani-Cloth® HB Germicidal Disposable Wipe	US	Wipe	Alcohol, Quaternary Ammonia
Sani-Cloth® Plus Germicidal Disposable Cloth	US	Wipe	Alcohol, Quaternary Ammonia
Tristel Trio Wipes System	UK	Pre-clean wipe, Sporicidal wipe, Rinse wipe	Enzymes, Chlorine Dioxide
Virox™ AHP® 5 RTU Wipes	CA	Wipe	Hydrogen Peroxide

- a. AU = Australia, CA = Canada, US = United States, UK = United Kingdom

## Sterilization Systems

The following sterilization systems are approved for use with the Viera™ Portable Breast Ultrasound and its batteries:

Sterilization System	For general reprocessing instructions, including proper cleaning, and drying, and packaging information prior to reprocessing any medical device using this system, refer to:	For specific sterilization efficacy questions, contact:
STERRAD® 100S (Short Cycle)	STERRAD® System User's Guides	STERRAD® Advanced Sterilization Products 1-888-STERRAD

## Glossary of Terms

For ultrasound terms not included in this glossary, refer to Recommended Ultrasound Terminology, Third Edition, published by AIUM.

### Acoustic Outputs

$A_{\text{aprt}}$

Area of the active aperture measured in  $\text{cm}^2$ .

$d_{\text{eq}}(z)$

Equivalent beam diameter as a function of axial distance  $z$ , and is equal to  $[(4/\pi)(W_o/I_{\text{TA}}(z))]^{0.5}$ , where  $I_{\text{TA}}(z)$  is the temporal-average intensity as a function of  $z$  in centimeters.

$d_{\text{eq@PII}_{\text{max}}}$

Equivalent beam diameter at the point where the free-field, spatial-peak pulse intensity integral is a maximum in centimeters.

depth

Refers to the depth of the display. A constant speed of sound of 1538.5 meters/second is assumed in the calculation of echo position in the image.

Dim. of  $A_{\text{aprt}}$

Active aperture dimensions for the azimuthal (x) and elevational (y) planes in centimeters.

**$f_c$** 

The center frequency (MHz). For MI,  $f_c$  is the center frequency associated with the transmit pattern giving rise to the global maximum reported value of MI. For TI, for combined modes involving transmit patterns of unequal center frequency,  $f_c$  is defined as the overall range of center frequencies of the respective transmit patterns.

**in situ**

In the natural or original position.

**FL**

Focal length, or azimuthal (x) and elevational (y) lengths, if different measured in centimeters.

 **$I_{pa.3}@MI_{max}$** 

Derated pulse average intensity at the maximum MI in units of  $W/cm^2$ .

 **$I_{SPTA.3}$** 

Derated spatial peak, temporal average intensity in units of milliwatts/ $cm^2$ .

 **$I_{SPTA.3z1}$** 

Derated spatial-peak temporal-average intensity at axial distance  $z_1$  in units of milliwatts/ $cm^2$ .

 **$I_{TA.3}(z_1)$** 

The derated spatial-peak temporal-average intensity at axial distance in units of milliwatts/ $cm^2$ .

**MI (mechanical index)**

An indication of the likelihood of mechanical bioeffects occurring. The higher the MI, the greater the likelihood of mechanical bioeffects.

**PD**

Pulse duration (microseconds) associated with the transmit pattern giving rise to the reported value of MI.

 **$P_{r.3}$** 

Derated peak rarefactional pressure associated with the transmit pattern giving rise to the value reported under MI in units of megapascals.

 **$p_r@PII_{max}$** 

Peak rarefactional pressure at the point where the free-field, spatial-peak pulse intensity integral is a maximum in units of megapascals.

**PRF**

Pulse repetition frequency associated with the transmit pattern giving rise to the reported value of MI in Hertz.

**TI (thermal index)**

The ratio of total acoustic power to the acoustic power required to raise tissue temperature by 1°C (1.8°F) under defined assumptions.

**TI type**

Applicable thermal index for the scanner, imaging mode, and exam type.

**TI value**

Thermal index value for the scanner, imaging mode, and exam type.

**TIB (bone thermal index)**

A thermal index for applications in which the ultrasound beam passes through soft tissue and a focal region is in the immediate vicinity of bone. TIB non-scan is the bone thermal index in the non-autoscanning mode.

**TIC (cranial bone thermal index)**

A thermal index for applications in which the ultrasound beam passes through bone near the beam entrance into the body.

**TIS (soft tissue thermal index)**

A thermal index related to soft tissues.

**TIS<sup>scan</sup>**

The soft tissue thermal index in an auto-scanning mode.

**TIS<sup>non-scan</sup>**

The soft tissue thermal index in the non-autoscanning mode.

**W<sub>3</sub>(z<sub>1</sub>)**

Derated ultrasonic power at axial distance z<sub>1</sub> in units of milliwatts.

**W<sub>0</sub>**

Ultrasonic power, except for TIS<sub>scan</sub>, in which case it is the ultrasonic power passing through a one-centimeter window in units of milliwatts.

**z<sub>1</sub>**

Axial distance corresponding to the location of maximum  $[\min(W_3(z), I_{TA,3}(z) \times 1 \text{ cm}^2)]$ , where  $z \geq z_{bp}$  in centimeters.

**Zbp**

1.69 ( $A_{\text{aprt}}$ ) in centimeters.

**zsp**

For MI, the axial distance at which pr.3 is measured. For TIB, the axial distance at which TIB is a global maximum (for example,  $z_{\text{sp}} = z_{\text{b},3}$ ) in centimeters.

**z@PII<sub>3max</sub>**

The axial distance corresponding to the maximum of the derated spatial-peak pulse intensity integral (megapascals).

## Acoustic Artifacts

**Acoustic saturation**

Occurs when received signals reach a system's high-amplitude limit. At that point the system becomes unable to distinguish or display signal intensities. At the point of saturation, increased input will not increase output.

**Aliasing**

Occurs when the detected Doppler frequency exceeds the Nyquist limit. It is characterized on the spectral display by the Doppler peaks going off the display, top or bottom, and then continuing on the other side of the baseline. On the Color display an immediate change in color from one Nyquist limit to the other is seen.

**Comet tail**

A form of reverberation artifact produced when two or more strong reflectors are close together and have a high propagation speed. In this case, sound does not travel directly to a reflector and back to the scanner, and a strong linear echo appears at the reflector and extends deeper than the reflector.

**Enhancement**

An increased relative amplitude of echoes caused by an intervening structure of low attenuation.

**Focal enhancement (focal banding)**

The increased intensity in the focal region that appears as a brightening of the echoes on the display.

**Mirror imaging artifact**

Most commonly seen around the diaphragm. This artifact results from sound reflecting off another reflector and back.



**Mirroring**

The appearance of artifacts on a spectral display when there is improper separation of forward and reverse signal processing channels. Consequently, strong signals from one channel mirror into the other.

**Multi-path positioning and refraction**

Artifacts that describe the situation in which the paths to and from a reflector are different. The longer the sound takes traveling to or from a reflector, the greater the axial error in reflector positioning (increased range). Refraction and multi-path positioning errors are normally relatively small and contribute to general degradation of the image rather than to gross errors in object location.

**Propagation speed errors**

Occur when the assumed value for propagation speed by the ultrasound system is incorrect. If the actual speed is greater than that assumed, the calculated distance to a reflector is too small, and the reflector will be displayed too far from the scanner. Speed error can cause a structure to be displayed with incorrect size and shape.

**Range ambiguity**

Can occur when reflections are received after the next pulse is transmitted. In ultrasound imaging, it is assumed that for each pulse produced, all reflections are received before the next pulse is sent out. The ultrasound system calculates the distance to a reflector from the echo arrival time assuming that all echoes were generated by the last emitted pulse. The maximum depth to be imaged unambiguously by the system determines its maximum pulse repetition frequency.

**Reverberation**

The continuing reception of a particular signal because of reverberation rather than reflection from a particular acoustic interface. This phenomenon is analogous to the effect created by mirrors positioned on opposite walls when an object, a head for instance, is placed between the mirrors. The image of the head is reflected back and forth infinitely between the two mirrors, creating the optical illusion of multiple heads. Reverberations are easily identifiable, because they are equally spaced on the display.

**Scattering**

Is the diffuse, low-amplitude sound waves that occur when acoustic energy reflects off tissue interfaces smaller than a wavelength. In diagnostic ultrasound, Doppler signals come primarily from acoustic energy back-scattered from red blood cells.

**Shadowing**

Is the reduction in echo amplitude from reflectors that lie behind a strongly reflecting or attenuating structure. This phenomenon occurs when scanning a lesion or structure with an attenuation rate higher than that of the surrounding tissue. The lesion causes a decrease in beam intensity, which results in decreased echo signals from the structures beyond the lesion. Consequently, a dark cloud behind the lesion image forms on the display. This cloud, or shadow, is useful as a diagnostic clue.

**Side lobes (from single-element scanners) and grating lobes (from array scanners)**

Cause objects that are not directly in front of the scanner to be displayed incorrectly in lateral position.

**Speckle**

Appears as tissue texture close to the scanner but does not correspond to scatterers in tissue. It is produced by ultrasound wave interference and results in general image degradation.

**Spectral broadening**

A display phenomenon that occurs when the number of energy-bearing Fourier frequency components increases at any given point in time. As a consequence, the spectral display is broadened. Spectral broadening can indicate the disturbed flow caused by a lesion, and therefore it is important diagnostically. However, broadening can also result from interaction between flow and sample volume size, in which case it is an artifact.

**Speed of sound artifacts**

Occur if the sound propagation path to a reflector is partially through bone, and the speed of sound is greater than in the average soft tissue. Echo position registration artifacts will be produced. Reflectors appear closer to the scanner than their actual distance because of this greater speed of sound, resulting in a shorter echo transit time than for paths not containing bone.

## Known Issues

For a list of currently known issues with the Viera™ Portable Breast Ultrasound, see <https://support.clarius.com/hc/en-us/articles/360019807731>.

# Acoustic Output Tables

## Viera™: B-Mode

**ACOUSTIC OUTPUT REPORTING TABLE FOR TRACK 3:  
SCANNER MODEL VIERA™ SCANNER, B-MODE OPERATION**

Index Label		MI	TIS		TIB		TIC
			At Surface	Below Surface	At Surface	Below Surface	
<b>Maximum Index Value</b>		1.00	(a)		(a)		(b)
<b>Index Component Value</b>			#	#	#	#	
<b>Acoustic Parameters</b>	$p_{r,a}$ at $Z_{MI}$	(MPa)	2.66				
	P	(mW)		#	#		#
	$P_{1x1}$	(mW)		#	#		
	$Z_s$	(cm)			#		
	$Z_b$	(cm)				#	
	$Z_{MI}$	(cm)	1.90				
	$Z_{pii,a}$	(cm)	1.90				
	$f_{awf}$	(MHz)	7.04	#	#		#
<b>Other Information</b>	pr	(Hz)	9600				
	sr	(Hz)	50.0				
	$n_{pps}$		1				
	$I_{pa,a}$ at $Z_{pii,a}$	(W/cm <sup>2</sup> )	285				
	$I_{spta,a}$ at $Z_{pii,a}$ or $Z_{sii,a}$	(mW/cm <sup>2</sup> )	3.07				
	$I_{spta,a}$ at $Z_{pii}$ or $Z_{sii}$	(mW/cm <sup>2</sup> )	7.73				
	$p_r$ at $Z_{pii}$	(MPa)	4.21				
<b>Operating Control Conditions</b>	Control 1		✓				
	Control 2						
	Control 3						
	Control 4						
	Control 5						
	Control 6						
	Control 7						

(a) Value < 1; the index is not required for this operating mode.

(b) This scanner is not intended for transcranial or neonatal cephalic use.

# Not reported for this operating condition; the maximum index value is not reported for the reasons shown in the Maximum Index Value fields.

— Not applicable for this scanner or mode.

Control 1: Depth: 4 cm; Mode: B

# Viera™: Color Doppler Mode

**ACOUSTIC OUTPUT REPORTING TABLE FOR TRACK 3:  
SCANNER MODEL VIERA™ SCANNER, COLOR DOPPLER OPERATION**

Index Label		MI	TIS		TIB		TIC
			At Surface	Below Surface	At Surface	Below Surface	
<b>Maximum Index Value</b>		(a)	(a)		(a)		(b)
<b>Index Component Value</b>			#	#	#	#	
<b>Acoustic Parameters</b>	$p_{r,a}$ at $Z_{MI}$	(MPa)	#				
	P	(mW)		#	#		#
	$P_{1x1}$	(mW)		#	#		
	$z_s$	(cm)			#		
	$z_b$	(cm)				#	
	$Z_{MI}$	(cm)	#				
	$Z_{pii,a}$	(cm)	#				
	$f_{awf}$	(MHz)	#	#	#		#
<b>Other Information</b>	pr	(Hz)	#				
	sr	(Hz)	#				
	$n_{pps}$		#				
	$I_{pa,a}$ at $Z_{pii,a}$	(W/cm <sup>2</sup> )	#				
	$I_{spta,a}$ at $Z_{pii,a}$ or $Z_{sii,a}$	(mW/cm <sup>2</sup> )	#				
	$I_{spta,a}$ at $Z_{pii}$ or $Z_{sii}$	(mW/cm <sup>2</sup> )	#				
	$p_r$ at $Z_{pii}$	(MPa)	#				
<b>Operating Control Conditions</b>	Control 1						
	Control 2						
	Control 3						
	Control 4						
	Control 5						
	Control 6						
	Control 7						

(a) Value < 1; the index is not required for this operating mode.

(b) This scanner is not intended for transcranial or neonatal cephalic use.

# Not reported for this operating condition; the maximum index value is not reported for the reasons shown in the Maximum Index Value fields.

— Not applicable for this scanner or mode.

# Viera™: M-Mode

**ACOUSTIC OUTPUT REPORTING TABLE FOR TRACK 3:  
SCANNER MODEL VIERA™ SCANNER, M-MODE OPERATION**

Index Label		MI	TIS		TIB		TIC
			At Surface	Below Surface	At Surface	Below Surface	
<b>Maximum Index Value</b>		1.00	(a)		(a)		(b)
<b>Index Component Value</b>			#	#	#	#	
<b>Acoustic Parameters</b>	$p_{r,a}$ at $Z_{MI}$	(MPa)	2.66				
	P	(mW)		#	#	#	#
	$P_{1x1}$	(mW)		#	#	#	#
	$z_s$	(cm)			#		
	$z_b$	(cm)				#	
	$Z_{MI}$	(cm)	1.90				
	$Z_{pii,a}$	(cm)	1.90				
	$f_{awf}$	(MHz)	7.04	#	#	#	#
<b>Other Information</b>	pr	(Hz)	200				
	srr	(Hz)	—				
	$n_{pps}$		1				
	$I_{pa,a}$ at $Z_{pii,a}$	(W/cm <sup>2</sup> )	285				
	$I_{spta,a}$ at $Z_{pii,a}$ or $Z_{sii,a}$	(mW/cm <sup>2</sup> )	10.3				
	$I_{spta,a}$ at $Z_{pii}$ or $Z_{sii}$	(mW/cm <sup>2</sup> )	25.8				
	$p_r$ at $Z_{pii}$	(MPa)	4.21				
<b>Operating Control Conditions</b>	Control 1		✓				
	Control 2						
	Control 3						
	Control 4						
	Control 5						
	Control 6						
	Control 7						

(a) Value < 1; the index is not required for this operating mode.

(b) This scanner is not intended for transcranial or neonatal cephalic use.

# Not reported for this operating condition; the maximum index value is not reported for the reasons shown in the Maximum Index Value fields.

— Not applicable for this scanner or mode.

Control 1: Depth: 4 cm; Mode: M

# Viera™: Needle Enhance B-Mode

**ACOUSTIC OUTPUT REPORTING TABLE FOR TRACK 3:  
SCANNER MODEL VIERA™ SCANNER, B-MODE OPERATION**

Index Label		MI	TIS		TIB		TIC
			At Surface	Below Surface	At Surface	Below Surface	
<b>Maximum Index Value</b>		1.08	(a)		(a)		(b)
<b>Index Component Value</b>			#	#	#	#	
<b>Acoustic Parameters</b>	$p_{r,a}$ at $Z_{MI}$	(MPa)	2.48				
	P	(mW)		#	#	#	#
	$P_{1x1}$	(mW)		#	#	#	#
	$z_s$	(cm)			#		
	$z_b$	(cm)				#	
	$Z_{MI}$	(cm)	1.90				
	$Z_{pii,a}$	(cm)	1.90				
	$f_{awf}$	(MHz)	5.24	#	#	#	#
<b>Other Information</b>	pr	(Hz)	2400				
	srr	(Hz)	25.0				
	$n_{pps}$		1				
	$I_{pa,a}$ at $Z_{pii,a}$	(W/cm <sup>2</sup> )	314				
	$I_{spta,a}$ at $Z_{pii,a}$ or $Z_{sii,a}$	(mW/cm <sup>2</sup> )	4.06				
	$I_{spta,a}$ at $Z_{pii}$ or $Z_{sii}$	(mW/cm <sup>2</sup> )	8.06				
	$p_r$ at $Z_{pii}$	(MPa)	3.50				
<b>Operating Control Conditions</b>	Control 1		✓				
	Control 2						
	Control 3						
	Control 4						
	Control 5						
	Control 6						
	Control 7						

(a) Value < 1; the index is not required for this operating mode.

(b) This scanner is not intended for transcranial or neonatal cephalic use.

# Not reported for this operating condition; the maximum index value is not reported for the reasons shown in the Maximum Index Value fields.

— Not applicable for this scanner or mode.

Control 1: Depth: 4 cm; Mode: Needle Enhance

# Revision History

## DOCUMENT REVISION HISTORY

User Manual Revision	Revision Date	Description
1	May 22, 2018	Added information for PW mode, Research mode, virtual scanners, automated heart rate feature, post-capture freeze, prospective/retrospective viewing. Removed auto-deletion feature, Clarius Clip-ons. (previously called v 4.1.0)
2	July 24, 2018	Updated Indications for Use, Intended Use tables, Contraindications, Cleaner & Disinfectant Usage, hyperlinks, scanner names, sterilization information, and usage instructions. Added Clarius Dock maximum working load. (previously called v 4.2.0)
3	February 22, 2019	<ul style="list-style-type: none"> <li>• Added: Clarius Cart, Managing Exams section, Measuring Tools section.</li> <li>• Updated: Cleaners &amp; Disinfectants section, Indications for Use section, Contraindications section, copyright page, 60601-1-12 compliance, Battery Charger Hub, battery life cycle, Doppler Sensitivity table, warranty.</li> <li>• Corrected IP67 definition.</li> <li>• Removed: Clarius Dock, C3-P Clip-on Intended Use table.</li> <li>• Transferred procedural information to Clarius website.</li> </ul>
4	May 21, 2019	<ul style="list-style-type: none"> <li>• Updated: CE marking number, idle time, battery and battery charger information, Acoustic Output tables, Indications for Use section, Contraindications section, TI &amp; MI information.</li> <li>• Renamed: "mobile device" to "smart device", "Apple Store App" to "Apple App Store", "Contraindications" to "Precautions".</li> <li>• Removed: surface temperature display.</li> </ul>



Headquarters:  
Clarius Mobile Health Corp.  
#350 - 3605 Gilmore Way  
Burnaby, BC V5G 4X5  
Canada  
1-778-800-9975  
[www.clarius.com](http://www.clarius.com)



Emergo Europe, Prinsessegracht 20 2514 AP,  
The Hague, The Netherlands